



**SPC BENCHMARK 2™
FULL DISCLOSURE REPORT**

**NETAPP, INC.
NETAPP EF560 ALL-FLASH ARRAY**

SPC-2™ V1.5

**Submitted for Review: April 29, 2016
Submission Identifier: B00078**

First Edition – April 2016

THE INFORMATION CONTAINED IN THIS DOCUMENT IS DISTRIBUTED ON AN AS IS BASIS WITHOUT ANY WARRANTY EITHER EXPRESS OR IMPLIED. The use of this information or the implementation of any of these techniques is the customer's responsibility and depends on the customer's ability to evaluate and integrate them into the customer's operational environment. While each item has been reviewed by NetApp, Inc. for accuracy in a specific situation, there is no guarantee that the same or similar results will be obtained elsewhere. Customers attempting to adapt these techniques to their own environment do so at their own risk.

This publication was produced in the United States. NetApp, Inc. may not offer the products, services, or features discussed in this document in other countries, and the information is subject to change with notice. Consult your local NetApp, Inc. representative for information on products and services available in your area.

© Copyright NetApp, Inc. 2016. All rights reserved.

Permission is hereby granted to reproduce this document in whole or in part, provided the copyright notice as printed above is set forth in full text on the title page of each item reproduced.

Trademarks

SPC Benchmark 2, SPC-2, SPC-2 MBPS, and SPC-2 Price-Performance are trademarks of the Storage Performance Council. NetApp, the NetApp logo, Data ONTAP, RAID-DP, Snapshot, WAFL and ONTAP are trademarks or registered trademarks of NetApp, Inc. in the United States and other countries. All other brands, trademarks, and product names are the property of their respective owners.

Table of Contents

Audit Certification	viii
Audit Certification (cont.)	ix
Letter of Good Faith	x
Executive Summary	11
Test Sponsor and Contact Information	11
Revision Information and Key Dates	11
Tested Storage Product (TSP) Description	11
SPC-2 Reported Data	12
SPC-2 Reported Data (continued)	13
Storage Capacities, Relationships and Utilization	14
Priced Storage Configuration Pricing	17
Differences between the Tested Storage Configuration and Priced Storage Configuration	17
Priced Storage Configuration Diagram	18
Priced Storage Configuration Components	19
Configuration Information	20
Benchmark Configuration (BC)/Tested Storage Configuration (TSC) Diagram .20	20
Storage Network Configuration	20
Host System and Tested Storage Configuration Table	20
Benchmark Configuration/Tested Storage Configuration Diagram	21
Host System and Tested Storage Configuration Components	22
Customer Tunable Parameters and Options	23
Tested Storage Configuration (TSC) Creation and Configuration	23
SPC-2 Workload Generator Storage Configuration	23
ASU Pre-Fill	24
SPC-2 Data Repository	25
SPC-2 Storage Capacities and Relationships	25
SPC-2 Storage Capacities	25
SPC-2 Storage Hierarchy Ratios	26
SPC-2 Storage Capacity Charts	26
Storage Capacity Utilization	28
Logical Volume Capacity and ASU Mapping	29
SPC-2 Benchmark Execution Results	30
SPC-2 Tests, Test Phases, Test Run Sequences, and Test Runs	30
Large File Processing Test	32

SPC-2 Workload Generator Commands and Parameters	32
SPC-2 Test Results File	33
SPC-2 Large File Processing Average Data Rates (MB/s)	33
SPC-2 Large File Processing Average Data Rates Graph	34
SPC-2 Large File Processing Average Data Rate per Stream	35
SPC-2 Large File Processing Average Data Rate per Stream Graph	36
SPC-2 Large File Processing Average Response Time.....	37
SPC-2 Large File Processing Average Response Time Graph	38
Large File Processing Test – WRITE ONLY Test Phase	39
SPC-2 “Large File Processing/WRITE ONLY/1024 KiB Transfer Size” Test Run Data ...	40
SPC-2 “Large File Processing/WRITE ONLY/1024 KiB Transfer Size” Graphs	40
Average Data Rate – Complete Test Run	40
Average Data Rate – Measurement Interval (MI) Only	40
Average Data Rate per Stream	40
Average Response Time	40
SPC-2 “Large File Processing/WRITE ONLY/256 KiB Transfer Size” Test Run Data	40
SPC-2 “Large File Processing/WRITE ONLY/256 KiB Transfer Size” Graphs	40
Average Data Rate – Complete Test Run	40
Average Data Rate – Measurement Interval (MI) Only	40
Average Data Rate per Stream	40
Average Response Time	40
Large File Processing Test – READ-WRITE Test Phase	41
SPC-2 “Large File Processing/READ-WRITE/1024 KiB Transfer Size” Test Run Data ...	42
SPC-2 “Large File Processing/READ-WRITE/1024 KiB Transfer Size” Graphs	42
Average Data Rate – Complete Test Run	42
Average Data Rate – Measurement Interval (MI) Only	42
Average Data Rate per Stream	42
Average Response Time	42
SPC-2 “Large File Processing/READ-WRITE/256 KiB Transfer Size” Test Run Data	42
SPC-2 “Large File Processing/READ-WRITE/256 KiB Transfer Size” Graphs	42
Average Data Rate – Complete Test Run	42
Average Data Rate – Measurement Interval (MI) Only	42
Average Data Rate per Stream	42
Average Response Time	42
Large File Processing Test – READ ONLY Test Phase	43
SPC-2 “Large File Processing/READ ONLY/1024 KiB Transfer Size” Test Run Data	44
SPC-2 “Large File Processing/READ ONLY/1024 KiB Transfer Size” Graphs	44
Average Data Rate – Complete Test Run	44
Average Data Rate – Measurement Interval (MI) Only	44

Average Data Rate per Stream	44
Average Response Time	44
SPC-2 “Large File Processing/READ ONLY/256 KiB Transfer Size” Test Run Data	44
SPC-2 “Large File Processing/READ ONLY/256 KiB Transfer Size” Graphs	44
Average Data Rate – Complete Test Run	44
Average Data Rate – Measurement Interval (MI) Only	44
Average Data Rate per Stream	44
Average Response Time	44
Large Database Query Test.....	45
SPC-2 Workload Generator Commands and Parameters	45
SPC-2 Test Results File	45
SPC-2 Large Database Query Average Data Rates (MB/s)	46
SPC-2 Large Database Query Average Data Rates Graph.....	46
SPC-2 Large Database Query Average Data Rate per Stream	47
SPC-2 Large Database Query Average Data Rate per Stream Graph.....	47
SPC-2 Large Database Query Average Response Time.....	48
SPC-2 Large Database Query Average Response Time Graph	48
Large Database Query Test – 1024 KiB TRANSFER SIZE Test Phase	49
SPC-2 “Large Database Query/1024 KiB TRANSFER SIZE/4 Outstanding I/Os” Test Run Data	50
SPC-2 “Large Database Query/1024 KiB TRANSFER SIZE/4 Outstanding I/Os” Graphs	50
Average Data Rate – Complete Test Run	50
Average Data Rate – Measurement Interval (MI) Only	50
Average Data Rate per Stream	50
Average Response Time	50
SPC-2 “Large Database Query/1024 KiB TRANSFER SIZE/1 Outstanding I/O” Test Run Data	50
SPC-2 “Large Database Query/1024 KiB TRANSFER SIZE/1 Outstanding I/O” Graphs..	50
Average Data Rate – Complete Test Run	50
Average Data Rate – Measurement Interval (MI) Only	50
Average Data Rate per Stream	50
Average Response Time	50
Large Database Query Test – 64 KiB TRANSFER SIZE Test Phase	51
SPC-2 “Large Database Query/64 KiB TRANSFER SIZE/4 Outstanding I/Os” Test Run Data	52
SPC-2 “Large Database Query/64 KiB TRANSFER SIZE/4 Outstanding I/Os” Graphs	52
Average Data Rate – Complete Test Run	52
Average Data Rate – Measurement Interval (MI) Only	52
Average Data Rate per Stream	52
Average Response Time	52

SPC-2 “Large Database Query/64 KIB TRANSFER SIZE/1 Outstanding I/O” Test Run Data	52
SPC-2 “Large Database Query/64 KIB TRANSFER SIZE/1 Outstanding I/O” Graphs.....	52
Average Data Rate – Complete Test Run	52
Average Data Rate – Measurement Interval (MI) Only	52
Average Data Rate per Stream	52
Average Response Time	52
Video on Demand Delivery Test	53
SPC-2 Workload Generator Commands and Parameters	53
SPC-2 Test Results File	54
SPC-2 Video on Demand Delivery Test Run Data	54
Video on Demand Delivery Test – TEST RUN DATA BY INTERVAL	55
SPC-2 Video on Demand Delivery Average Data Rate Graph	56
SPC-2 Video on Demand Delivery Average Data Rate per Stream Graph.....	56
SPC-2 Video on Demand Delivery Average Response Time Graph	57
SPC-2 Video on Demand Delivery Maximum Response Time Graph.....	57
Data Persistence Test.....	58
SPC-2 Workload Generator Commands and Parameters	58
Data Persistence Test Results File	58
Data Persistence Test Results.....	59
Priced Storage Configuration Availability Date.....	60
Anomalies or Irregularities	60
Appendix A: SPC-2 Glossary	61
“Decimal” (<i>powers of ten</i>) Measurement Units.....	61
“Binary” (<i>powers of two</i>) Measurement Units.....	61
SPC-2 Data Repository Definitions	61
SPC-2 Data Protection Levels	62
SPC-2 Test Execution Definitions	62
I/O Completion Types	65
SPC-2 Test Run Components	65
Appendix B: Customer Tunable Parameters and Options.....	66
HBA Parameters	66
Windows Registry Settings	66
HBA Transfer Size.....	66
Storage Array Parameters	67
Appendix C: Tested Storage Configuration (TSC) Creation	68
QLogic HBA Parameters.....	68
HBA Transfer Size Setting	68

Windows Registry Setting	68
Storage Array Volume Creation	68
SPC-2 Logical Volume Creation.....	69
SPC2_RAID_Config.script	69
Appendix D: SPC-2 Workload Generator Storage Commands and Parameter Files	70
ASU Pre-Fill.....	70
Common Commands/Parameters – LFP, LDQ, VOD and Persistence Tests.....	70
Large File Processing Test (LFP)	71
Large Database Query Test (LDQ)	72
Video on Demand Delivery (VOD).....	73
SPC-2 Persistence Test Run 1 (write phase).....	73
SPC-2 Persistence Test Run 2 (<i>read phase</i>)	73
Appendix E: SPC-2 Workload Generator Execution Commands and Parameters	74
ASU Pre-Fill, Large File Processing Test, Large Database Query Test, Video on Demand Delivery Test, and SPC-2 Persistence Test Run 1 (<i>write phase</i>)	74
phase1.spc2.bat	75
SPC-2 Persistence Test Run 2 (<i>read phase</i>)	76
phase2.spc2.bat	76
Third-Party Quotation	77
QLogic QLE2672-CK HBAs	77
Fibre Channel Cables	78

AUDIT CERTIFICATION



Mark Register
 NetApp, Inc.
 3718 North Rock Road
 Wichita, KS 67226

April 27, 2016

The SPC Benchmark 2™ Reported Data listed below for the **NetApp EF560 All-Flash Array** was produced in compliance with the SPC Benchmark 2™ V1.5 Remote Audit requirements.

SPC Benchmark 2™ V1.5 Reported Data	
Tested Storage Product (TSP) Name: NetApp EF560 All-Flash Array	
Metric	Reported Result
SPC-2 MBPS™	11,352.17
SPC-2 Price-Performance	\$8.12/SPC-2 MBPS™
ASU Capacity	12,708.137 GB
Data Protection Level	Protected 2 (RAID-6)
Total Price (including three-year maintenance)	\$92,207.01
Currency Used	U.S. Dollars
Target Country for availability, sales and support	USA

The following SPC Benchmark 2™ Remote Audit requirements were reviewed and found compliant with V1.5 of the SPC Benchmark 2™ specification:

- A Letter of Good Faith, signed by a senior executive.
- The following Data Repository storage items were verified by documentation supplied by NetApp, Inc.:
 - ✓ Physical Storage Capacity and related requirements.
 - ✓ Configured Storage Capacity and related requirements.
 - ✓ Addressable Storage Capacity and related requirements.
 - ✓ Capacity of each Logical Volume and related requirements.
 - ✓ Capacity of the Application Storage Unit (ASU) and related requirements.
- The total Application Storage Unit (ASU) Capacity was filled with random data prior to the execution of the SPC-2 Tests

Gradient Systems, Inc.
 643 Bair Island Road, Suite 103
 Redwood City, CA 94062
AuditService@StoragePerformance.org
 650.556.9384

AUDIT CERTIFICATION (CONT.)

NetApp EF560 All-Flash Array
SPC-2 Audit Certification

Page 2

- An appropriate diagram of the Benchmark Configuration (BC)/Tested Storage Configuration (TSC).
- Documentation supplied by NetApp, Inc. to verify the components matched the above diagram.
- Listings and commands used to create and configure the Benchmark Configuration/Tested Storage Configuration.
- Documentation that no customer tunable parameter or option was changed from its default value.
- The following Host System items were verified by documentation supplied by NetApp, Inc.:
 - ✓ Required Host System configuration information.
 - ✓ The TSC boundary within the Host System.
- The following SPC-2 Workload Generator information was verified by documentation supplied by NetApp, Inc.:
 - ✓ The presence and version number of the Workload Generator on each Host System.
 - ✓ Commands and parameters used to configure the SPC-2 Workload Generator.
- The Test Results Files and resultant Summary Results Files received from NetApp, Inc. for each of the following were authentic, accurate, and compliant with all of the requirements and constraints of Clauses 6 and 7 of the SPC-2 Benchmark Specification:
 - ✓ Data Persistence Test
 - ✓ Large File Processing Test
 - ✓ Large Database Query Test
 - ✓ Video on Demand Delivery Test
- There were no differences between the Tested Storage Configuration and Priced Storage Configuration.
- The submitted pricing information met all of the requirements and constraints of Clause 9 of the SPC-2 Benchmark Specification.
- The Full Disclosure Report (FDR) met all of the requirements in Clause 10 of the SPC-2 Benchmark Specification.
- This successfully audited SPC measurement is not subject to an SPC Confidential Review.

Audit Notes:

There were no audit notes or exceptions.

Respectfully,

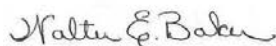

Walter E. Baker
SPC Auditor

Gradient Systems, Inc.
643 Bair Island Road, Suite 103
Redwood City, CA 94062
AuditService@StoragePerformance.org
650.556.9384

LETTER OF GOOD FAITH



www.netapp.com

316.636.8000 Tel

3718 N. Rock Road
Wichita, KS 67226

February 18, 2016

Mr. Walter E. Baker, SPC Auditor
Gradient Systems
643 Bair Island Road, Suite 103
Redwood City, CA 94063

Subject: SPC-2 Letter of Good Faith for the NetApp EF560 Storage System w/11.25

NetApp Inc. is the SPC-2 test sponsor for the above listed product. To the best of our knowledge and belief, the required SPC-2 results and materials we have submitted for that product are complete, accurate, and in full compliance with version 1.5 of the SPC-2 benchmark specification.

In addition, we have reported any items in the Benchmark Configuration and execution of the benchmark that affected the reported results even if the items are not explicitly required to be disclosed by the SPC-2 benchmark specification.

Sincerely,

Eric Stoltman (Feb 18, 2016)

Eric Stoltman
VP & GM, HSG

February 18, 2016

Date

Legal Reference

EXECUTIVE SUMMARY

Test Sponsor and Contact Information

Test Sponsor and Contact Information	
Test Sponsor Primary Contact	NetApp, Inc. – http://www.netapp.com Mark Regester – mark.regester@netapp.com 3718 North Rock Road Wichita, KS 67226 Phone: (316) 636-8340
Test Sponsor Alternate Contact	NetApp, Inc. – http://www.netapp.com Mike Phelan – mike.phelan@netapp.com 5400 Airport Blvd., Suite 100 Boulder, CO 80301 Phone: (303) 544-5414
Auditor	Storage Performance Council – http://www.storageperformance.org Walter E. Baker – AuditService@StoragePerformance.org 643 Bair Island Road, Suite 103 Redwood City, CA 94063 Phone: (650) 556-9384 FAX: (650) 556-9385

Revision Information and Key Dates

Revision Information and Key Dates	
SPC-2 Specification revision number	V1.5
SPC-2 Workload Generator revision number	V1.2
Date Results were first used publicly	April 29, 2016
Date FDR was submitted to the SPC	April 29, 2016
Date the TSC will be available for shipment to customers	currently available
Date the TSC completed audit certification	April 27, 2016

Tested Storage Product (TSP) Description

The NetApp® EF560 flash array is an all-SSD storage system that brings together extreme performance and enterprise-grade reliability to create a system optimized for latency-sensitive workloads. Designed for applications demanding the highest levels of performance, reliability, and availability and requiring just 2U of rack space, the EF560 flash array delivers consistent microsecond latency response times, and enterprise-proven availability features. Additionally, the EF560 can be seamlessly expanded to 120 SSDs to a maximum raw capacity of 384TB. The EF560's core architecture has been proven in the world's most demanding and complex computing environments. Its field-proven design is the culmination of over 20 years of industry knowledge focused on designing enterprise-class storage. The fully redundant EF-Series all-flash array is architected to provide the highest levels of reliability, availability, and data protection.

SPC-2 Reported Data

SPC-2 Reported Data consists of three groups of information:

- The following SPC-2 Primary Metrics, which characterize the overall benchmark result:
 - SPC-2 MBPS™
 - SPC-2 Price Performance™
 - Application Storage Unit (ASU) Capacity
- Supplemental data to the SPC-2 Primary Metrics.
 - Total Price
 - Data Protection Level
 - Currency Used
 - Target Country
- Reported Data for each SPC Test: Large File Processing (LFP), Large Database Query (LDQ), and Video on Demand Delivery (VOD) Test.

SPC-2 MBPS™ represents the aggregate data rate, in megabytes per second, of all three SPC-2 workloads: Large File Processing (LFP), Large Database Query (LDQ), and Video on Demand (VOD).

SPC-2 Price-Performance™ is the ratio of **Total Price** to **SPC-2 MBPS™**.

ASU (Application Storage Unit) Capacity represents the total storage capacity available to be read and written in the course of executing the SPC-2 benchmark.

Total Price includes the cost of the Priced Storage Configuration plus three years of hardware maintenance and software support as detailed on page 17.

Data Protection Level of Protected 2 using **RAID-6**, which provides double-party RAID protection against data loss.

***Protected 2:** The single point of failure of any **component** in the configuration will not result in permanent loss of access to or integrity of the SPC-2 Data Repository.*

Currency Used is formal name for the currency used in calculating the **Total Price** and **SPC-2 Price-Performance™**. That currency may be the local currency of the **Target Country** or the currency of a difference country (*non-local currency*).

The **Target Country** is the country in which the Priced Storage Configuration is available for sale and in which the required hardware maintenance and software support is provided either directly from the Test Sponsor or indirectly via a third-party supplier.

SPC-2 Reported Data (continued)

SPC-2 Reported Data				
NetApp EF560 All-Flash Array				
SPC-2 MBPS™	SPC-2 Price-Performance	ASU Capacity (GB)	Total Price	Data Protection Level
11,352.17	\$8.12	12,708.137	\$92,207.01	Protected 2 (RAID-6)
<i>The above SPC-2 MBPS™ value represents the aggregate data rate of all three SPC-2 workloads: Large File Processing (LFP), Large Database Query (LDQ), and Video On Demand (VOD)</i>				
Currency Used:		"Target Country":		
U.S. dollars		USA		
SPC-2 Large File Processing (LFP) Reported Data				
	Data Rate (MB/second)	Number of Streams	Data Rate per Stream	Price-Performance
LFP Composite	10,020.15			\$9.20
Write Only:				
1024 KiB Transfer	6,790.89	96	70.74	
256 KiB Transfer	6,562.37	96	68.36	
Read-Write:				
1024 KiB Transfer	10,179.46	96	106.04	
256 KiB Transfer	10,685.71	96	111.31	
Read Only:				
1024 KiB Transfer	13,185.58	96	137.35	
256 KiB Transfer	12,716.91	96	132.47	
<i>The above SPC-2 Data Rate value for LFP Composite represents the aggregate performance of all three LFP Test Phases: (Write Only, Read-Write, and Read Only).</i>				
SPC-2 Large Database Query (LDQ) Reported Data				
	Data Rate (MB/second)	Number of Streams	Data Rate per Stream	Price-Performance
LDQ Composite	13,026.34			\$7.08
1024 KiB Transfer Size				
4 I/Os Outstanding	13,303.28	96	138.58	
1 I/O Outstanding	13,292.79	96	138.47	
64 KiB Transfer Size				
4 I/Os Outstanding	12,756.95	96	132.88	
1 I/O Outstanding	12,752.32	96	132.84	
<i>The above SPC-2 Data Rate value for LDQ Composite represents the aggregate performance of the two LDQ Test Phases: (1024 KiB and 64 KiB Transfer Sizes).</i>				
SPC-2 Video On Demand (VOD) Reported Data				
	Data Rate (MB/second)	Number of Streams	Data Rate per Stream	Price-Performance
	11,010.03	14,000	0.79	\$8.37

Storage Capacities, Relationships and Utilization

The following four charts and table document the various storage capacities, used in this benchmark, and their relationships, as well as the storage utilization values required to be reported.

The capacity values in each of the following four charts are listed as integer values, for readability, rather than the decimal values listed elsewhere in this document.

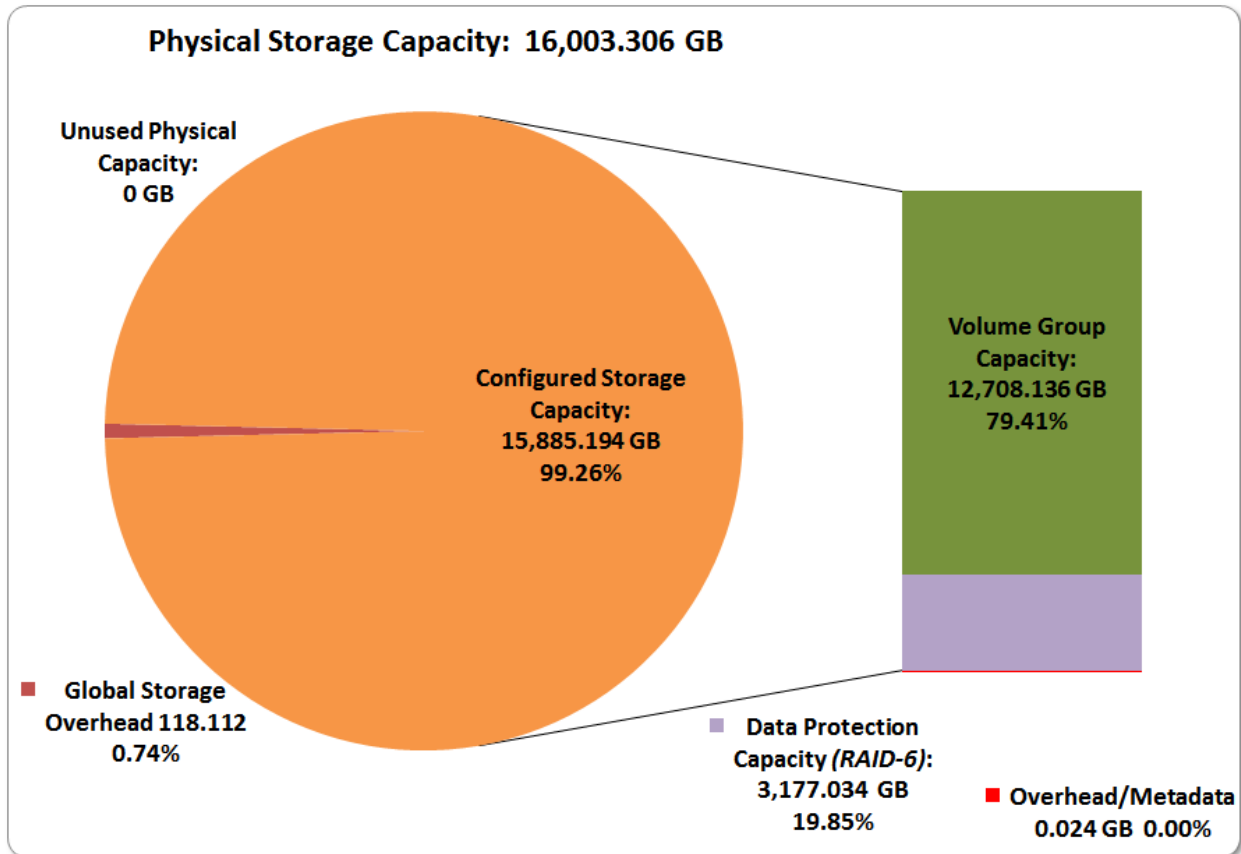

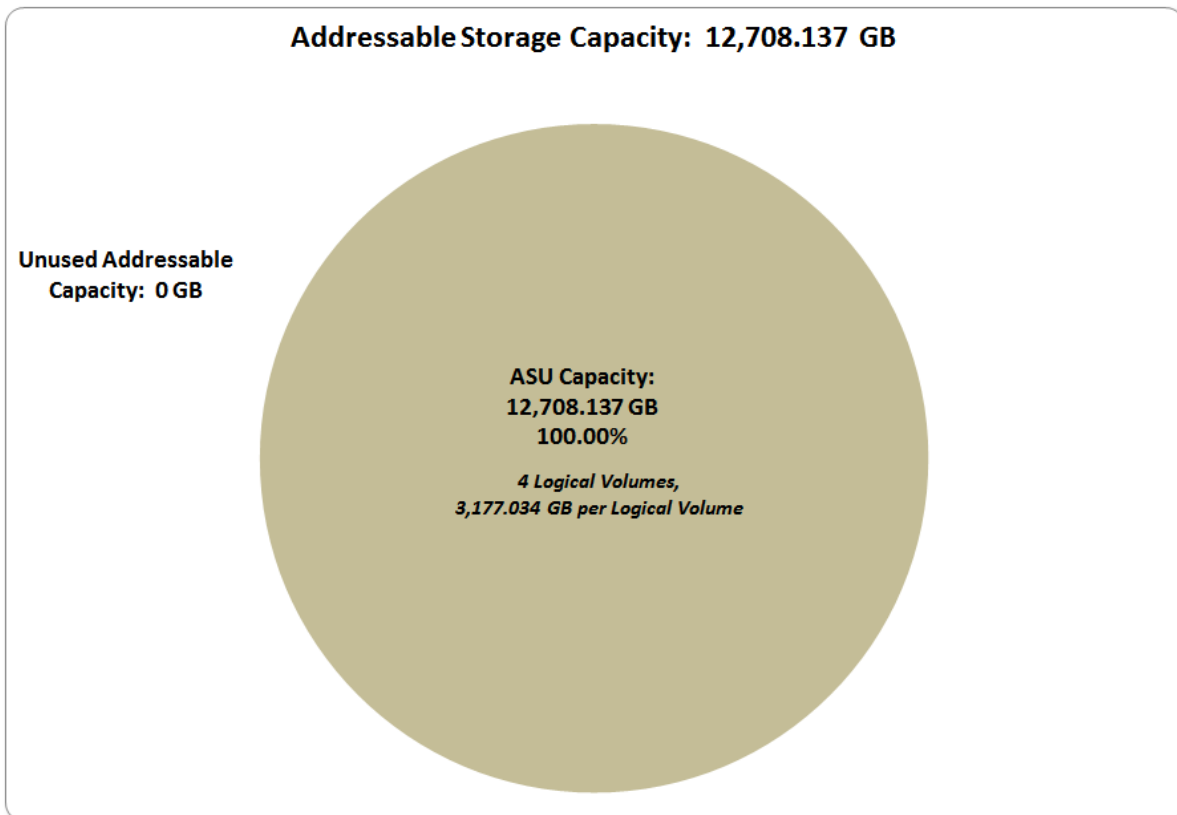
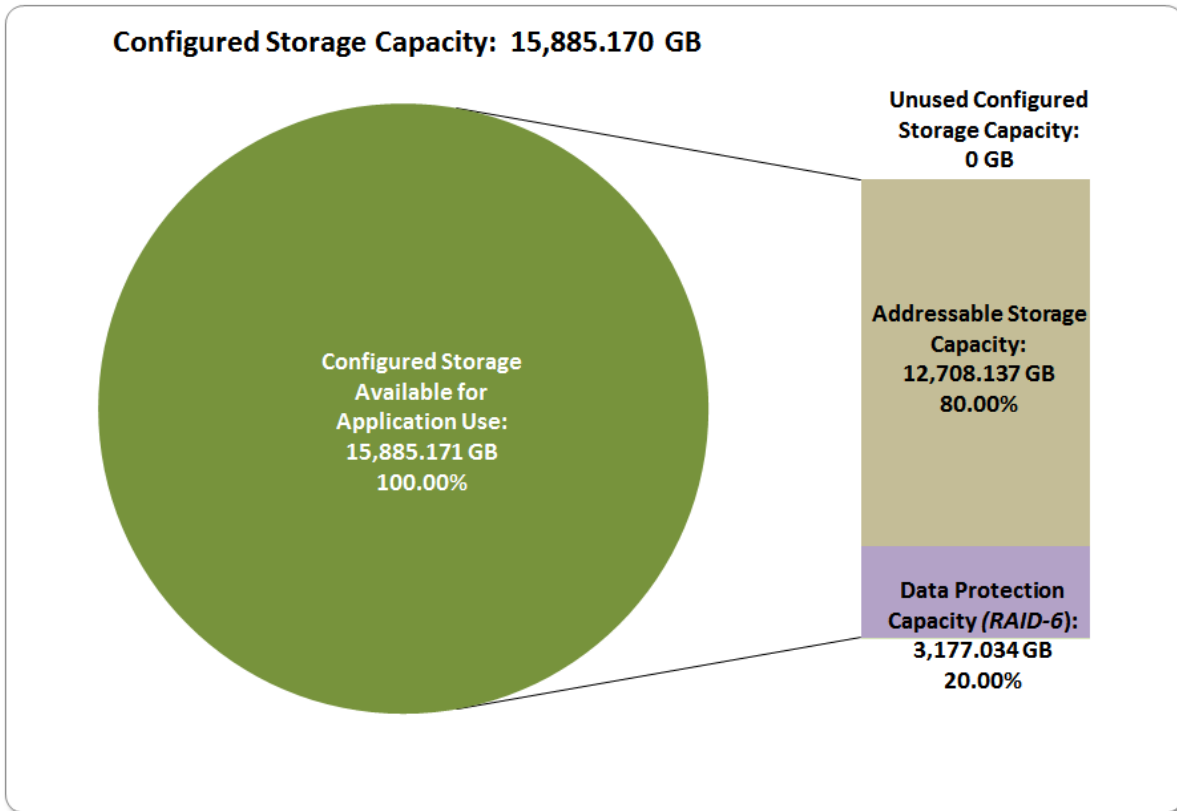

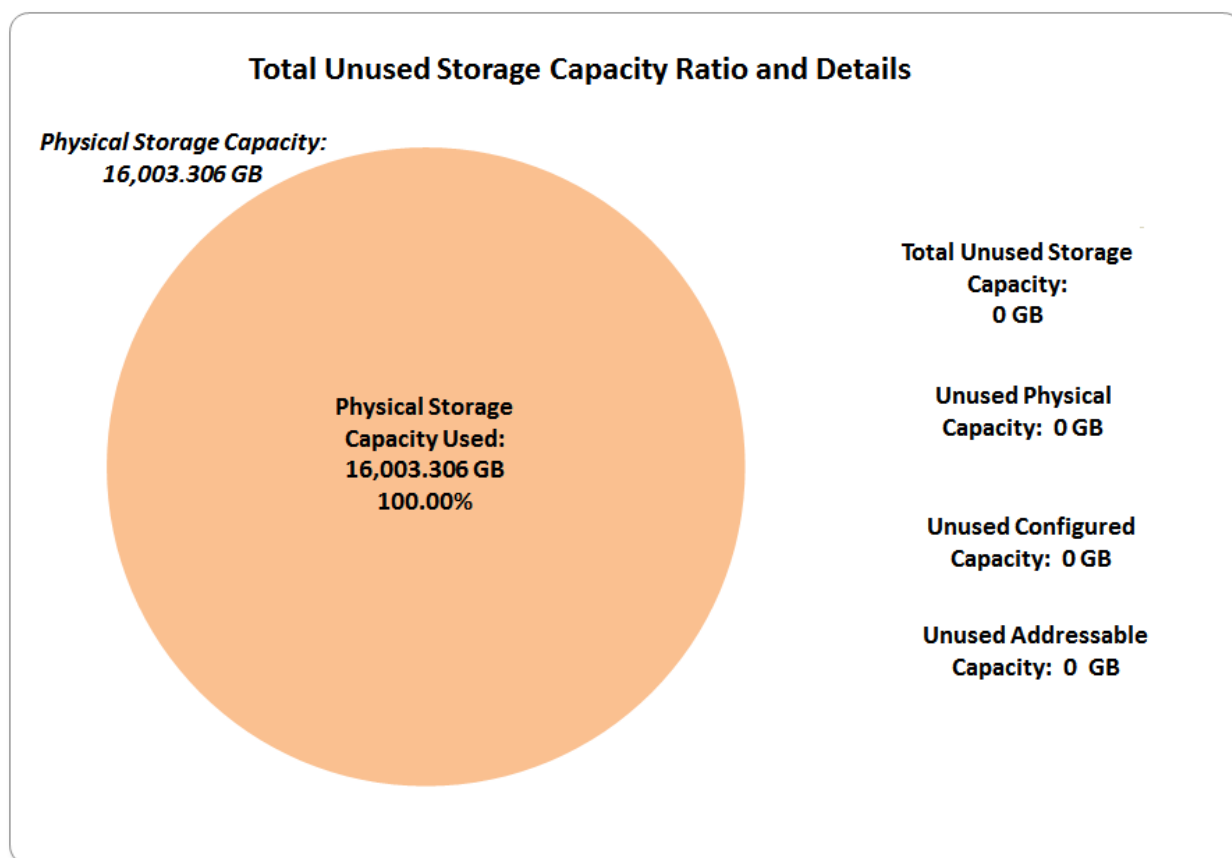

SPC-2 Storage Capacity Utilization	
Application Utilization	79.41%
Protected Application Utilization	99.26%
Unused Storage Ratio	0.00%

Application Utilization: ASU Capacity (12,708.137 GB) divided by Physical Storage Capacity (16,003.306 GB).

Protected Application Utilization: ASU Capacity (12,708.137 GB) plus total Data Protection Capacity (3,177.034 GB) minus unused Data Protection Capacity (0.000 GB) divided by Physical Storage Capacity (16,003.306 GB).

Unused Storage Ratio: Total Unused Capacity (0.000 GB) divided by Physical Storage Capacity (16,003.306 GB) and may not exceed 45%.

Detailed information for the various storage capacities and utilizations is available on pages 25-26 in the Full Disclosure Report.

Priced Storage Configuration Pricing

Part Number	Description	Quantity	Unit List Price	Extended LP
EF-X5681A-R6-C	Enclosure,EF5X0,Empty,2PSU,-C	1	\$ 3,880.00	\$ 3,880.00
EF-X5681A-DM-R6-C	Enclosure,EF5X0,Empty,2PSU,DM,-C	1	\$ 3,880.00	\$ 3,880.00
EF-X561202A-R6-C	EF560A,12GB Controller,16Gb FC,4-ports,-C	2	\$ 21,925.00	\$ 43,850.00
E-X30030A-R6-C	ESM,SBB-2,-C	2	\$ 2,630.00	\$ 5,260.00
EF-X4041C-C	SSD,800GB,Non-FDE,EF5X0,-C	20	\$ 2,705.00	\$ 54,100.00
OS-SANTRCTY-CAP3-EF-C	OS Enable,Per-0.1TB,SANTRCTY,Ultra-Stor,EF,-C	160	\$ 284.00	\$ 45,440.00
X-35610-00-R6-C	Blank,Dsk Drv Filler,DE5600,-C	28	\$ 25.00	\$ 700.00
X-20004-00-R6-C	Cable,miniSAS,1m,-C	4	\$ 125.00	\$ 500.00
X-48895-00-R6-C	SFP,10Gb iSCSI/16Gb FC,Unified,E-Series,-C	8	\$ 600.00	\$ 4,800.00
	NetApp Hardware/Software Subtotal			\$ 162,410.00

CS-A2-4R-VA	Support, 3-yr 24/7, 4 hour on-site	1	\$ 11,236.18	\$ 11,236.18
-------------	------------------------------------	---	--------------	--------------

ServerSupply QLE2672-CK	QLE2672-CK Qlogic HBA, 16Gb FC, 2-ports	4	\$ 1,300.00	\$ 5,200.00
CDW 1148024	Tripp Lite, OM3 Optical cable, 2	8	\$ 22.99	\$ 183.92
	Third-Party Subtotal			\$ 5,383.92

Description	Extended LP	Discount	Discounted Price
NetApp Hardware/Software Subtotal	\$ 162,410.00	50%	\$ 81,205.00
Support	\$ 11,236.18	50%	\$ 5,618.09
Third-Party Subtotal	\$ 5,383.92	0%	\$ 5,383.92
Totals	\$ 179,030.10		\$ 92,207.01

The above pricing includes the following:

- Acknowledgement of new and existing hardware and/or software problems within four hours.
- Onsite presence of a qualified maintenance engineer or provision of a customer replaceable part within four hours of the above acknowledgement for any hardware failure that results in an inoperative Priced Storage Configuration component.

Differences between the Tested Storage Configuration and Priced Storage Configuration

There were no differences between the Tested Storage Configuration and the Priced Storage Configuration.

Priced Storage Configuration Diagram

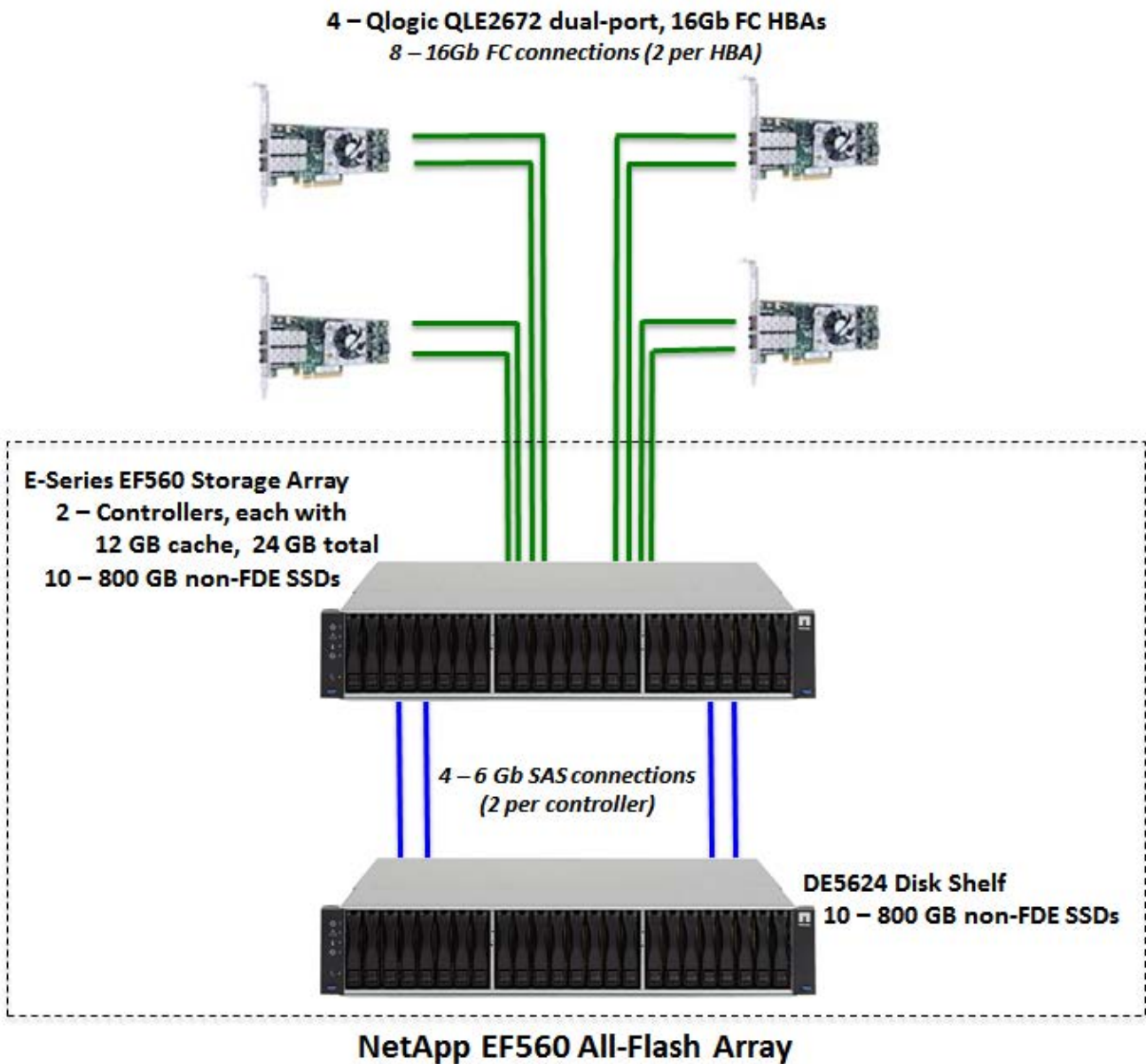

Priced Storage Configuration Components

Priced Storage Configuration
4 – QLogic QLE2672-CK dual-port, 16Gb, FC HBAs
NetApp EF560 All-Flash Array 1 – E-Series EF560 Storage Array with 2 – Controllers, each Controller includes: 12 GB cache <i>(24 GB total)</i> 4 – 16 Gb FC front-end connections <i>(8 total and used)</i> 5 – 4 x 6Gb SAS backend connections <i>(10 total and used)</i>
1 – DE5624 Disk Shelf
20 – 800 GB non-FDE SSDs <i>(10 SSDs in Storage Array) (10 SSDs in Disk Shelf)</i>

CONFIGURATION INFORMATION

This portion of the Full Disclosure Report documents and illustrates the detailed information necessary to recreate the Benchmark Configuration (BC), including the Tested Storage Configuration (TSC), so that the SPC-2 benchmark result produced by the BC may be independently reproduced.

In each of the following sections of this document, the appropriate Full Disclosure Report requirement, from the SPC-2 benchmark specification, is stated in italics followed by the information to fulfill the stated requirement.

Benchmark Configuration (BC)/Tested Storage Configuration (TSC) Diagram

Clause 10.6.6

The FDR will contain a one page BC/TSC diagram that illustrates all major components of the BC/TSC.

The Benchmark Configuration (BC)/Tested Storage Configuration (TSC) is illustrated on page [21 \(Benchmark Configuration \(BC\)/Tested Storage Configuration \(TSC\) Diagram\)](#).

Storage Network Configuration

Clause 10.6.6.1

If a storage network was configured as a part of the Tested Storage Configuration and the Benchmark Configuration described in Clause 10.6.6 contains a high-level illustration of the network configuration, the Executive Summary will contain a one page topology diagram of the storage network as illustrated in Figure 10.11.

The Tested Storage Configuration was configured with direct attached storage.

Host System and Tested Storage Configuration Table

Clause 10.6.6.2

The FDR will contain a table that lists the major components of each Host System and the Tested Storage Configuration.

The components that comprise each Host System and the Tested Storage Configuration are listed in the table that appears on page [22 \(Host System and Tested Storage Configuration Components\)](#).

Benchmark Configuration/Tested Storage Configuration Diagram

2 – Dell PowerEdge R730 servers

4 – Qlogic QLE2672 dual-port, 16Gb FC HBAs (2 per server)

8 – 16Gb connections (2 per HBA, 4 per server)

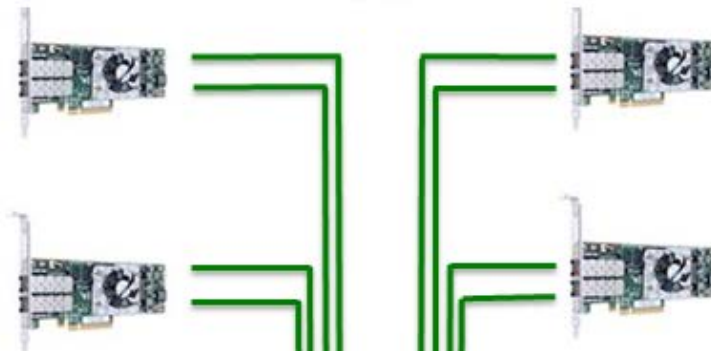

E-Series EF560 Storage Array
2 – Controllers, each with
12 GB cache, 24 GB total
10 – 800 GB non-FDE SSDs



4 – 6 Gb SAS connections
(2 per controller)



DE5624 Disk Shelf
10 – 800 GB non-FDE SSDs

NetApp EF560 All-Flash Array

Host System and Tested Storage Configuration Components

<p>Host Systems</p> <p>2 – Dell PowerEdge R730 servers, each with:</p> <ul style="list-style-type: none"> 2 – Intel® Xeon® E5-2630 V3 processors 2.40 GHz each with 8 cores, 2x256 KB L2 Cache, 20 MB L3 Cache 64 GB main memory Windows Server 2008 R2 Enterprise version 6.1 (Build 7601: Service Pack 1) PCIe
<p>Tested Storage Configuration</p> <p>4 – QLogic QLE2672-CK dual-port, 16Gb, FC HBAs (2 HBAs per server)</p> <p>NetApp EF560 All-Flash Array</p> <ul style="list-style-type: none"> 1 – E-Series EF560 Storage Array with <ul style="list-style-type: none"> 2 – Controllers, each Controller includes: <ul style="list-style-type: none"> 12 GB cache (24 GB total) 4 – 16 Gb FC front-end connections (8 total and used) 5 – 4 x 6Gb SAS backend connections (10 total and used) 1 – DE5624 Disk Shelf 20 – 800 GB non-FDE SSDs (10 SSDs in Storage Array) (10 SSDs in Disk Shelf)

Customer Tunable Parameters and Options

Clause 10.6.7.1

All Benchmark Configuration (BC) components with customer tunable parameter and options that have been altered from their default values must be listed in the FDR. The FDR entry for each of those components must include both the name of the component and the altered value of the parameter or option. If the parameter name is not self-explanatory to a knowledgeable practitioner, a brief description of the parameter's use must also be included in the FDR entry.

[Appendix B: Customer Tunable Parameters and Options](#) on page 66 contains the customer tunable parameters and options that have been altered from their default values for this benchmark.

Tested Storage Configuration (TSC) Creation and Configuration

Clause 10.6.7.2

The Full Disclosure Report must include sufficient information to recreate the logical representation of the Tested Storage Configuration (TSC). In addition to customer tunable parameters and options (Clause 10.6.6.1), that information must include, at a minimum:

- A diagram and/or description of the following:
 - All physical components that comprise the TSC. Those components are also illustrated in the BC Configuration Diagram in Clause 10.6.5.7 and the Storage Network Configuration Diagram in Clause 10.6.5.8.
 - The logical representation of the TSC, configured from the above components that will be presented to the SPC-2 Workload Generator.
- Listings of scripts used to create the logical representation of the TSC.
- If scripts were not used, a description of the process used with sufficient detail to recreate the logical representation of the TSC.

[Appendix C: Tested Storage Configuration \(TSC\) Creation](#) on page 68 contains the detailed information that describes how to create and configure the logical TSC.

SPC-2 Workload Generator Storage Configuration

Clause 10.6.7.3

The Full Disclosure Report will include all SPC-2 Workload Generator storage configuration commands and parameters used in the SPC-2 benchmark measurement.

The SPC-2 Workload Generator storage configuration commands and parameters for this measurement appear in [Appendix D: SPC-2 Workload Generator Storage Commands and Parameter Files](#) on page 70.

ASU Pre-Fill

Clause 6.3.3

The SPC-2 ASU is required to be completely filled with specified content prior to the execution of audited SPC-2 Tests. The content is required to consist of random data pattern such as that produced by an SPC recommended tool.

...

Clause 6.3.3.3

The required ASU pre-fill must be executed as the first step in the uninterrupted benchmark execution sequence described in Clause 6.4.2. That uninterrupted sequence will consist of: ASU Pre-Fill, Large File Processing, Large Database Query, Video on Demand Delivery and Persistence Test Run 1. The only exception to this requirement is described in Clause 6.3.3.4.

Clause 6.3.3.4

If approved by the Auditor, the Test Sponsor may complete the required ASU pre-fill prior to the execution of the audited SPC-2 Tests and not as part of the SPC-2 Test execution sequence.

The Auditor will verify the required random data pattern content in the ASU prior to the execution of the audited SPC-2 Tests. If that verification fails, the Test Sponsor is required to reload the specified content to the ASU.

The configuration file used to complete the required ASU pre-fill appears in [Appendix D: SPC-2 Workload Generator Storage Commands and Parameter Files](#) on page [70](#).

SPC-2 DATA REPOSITORY

This portion of the Full Disclosure Report presents the detailed information that fully documents the various SPC-2 storage capacities and mappings used in the Tested Storage Configuration. [SPC-2 Data Repository Definitions](#) on page [61](#) contains definitions of terms specific to the SPC-2 Data Repository.

In each of the following sections of this document, the appropriate Full Disclosure Report requirement, from the SPC-2 benchmark specification, is stated in italics followed by the information to fulfill the stated requirement.

SPC-2 Storage Capacities and Relationships

Clause 10.6.8.1

Two tables and four charts documenting the storage capacities and relationships of the SPC-2 Storage Hierarchy (Clause 2.1) shall be included in the FDR. ... The capacity value in each chart may be listed as an integer value, for readability, rather than the decimal value listed in the table below.

SPC-2 Storage Capacities

The Physical Storage Capacity consisted of 16,003.306 GB distributed over 20 solid state devices (SSDs) each with a formatted capacity of 800.165 GB. There was 0.000 GB (0.00%) of Unused Storage within the Physical Storage Capacity. Global Storage Overhead consisted of 118.112 GB (0.74%) of the Physical Storage Capacity. There was 0.000 GB (0.00%) of Unused Storage within the Configured Storage Capacity. The Total ASU Capacity utilized 100.00% of the Addressable Storage Capacity resulting in 0.000 GB (0.00%) of Unused Storage within the Addressable Storage Capacity. The Data Protection capacity (*RAID-6*) was 3,177.034 GB of which 3,177.034 GB was utilized. The total Unused Storage was 0.000 GB.

Note: The configured Storage Devices may include additional storage capacity reserved for system overhead, which is not accessible for application use. That storage capacity may not be included in the value presented for Physical Storage Capacity.

SPC-2 Storage Capacities		
Storage Hierarchy Component	Units	Capacity
Total ASU Capacity	Gigabytes (GB)	12,708.137
Addressable Storage Capacity	Gigabytes (GB)	12,708.137
Configured Storage Capacity	Gigabytes (GB)	15,885.170
Physical Storage Capacity	Gigabytes (GB)	16,003.306
Data Protection (<i>RAID-6</i>)	Gigabytes (GB)	3,177.034
Required Storage (<i>metadata/overhead</i>)	Gigabytes (GB)	0.024
Global Storage Overhead	Gigabytes (GB)	118.112
Total Unused Storage	Gigabytes (GB)	0.000

SPC-2 Storage Hierarchy Ratios

	Addressable Storage Capacity	Configured Storage Capacity	Physical Storage Capacity
Total ASU Capacity	100.00%	80.00%	79.41%
Data Protection (RAID-6)		20.00%	19.85%
Addressable Storage Capacity		80.00%	79.41%
Required Storage		0.00%	0.00%
Configured Storage Capacity			99.26%
Global Storage Overhead			0.74%
Unused Storage:			
Addressable	0.00%		
Configured		0.00%	
Physical			0.00%

SPC-2 Storage Capacity Charts

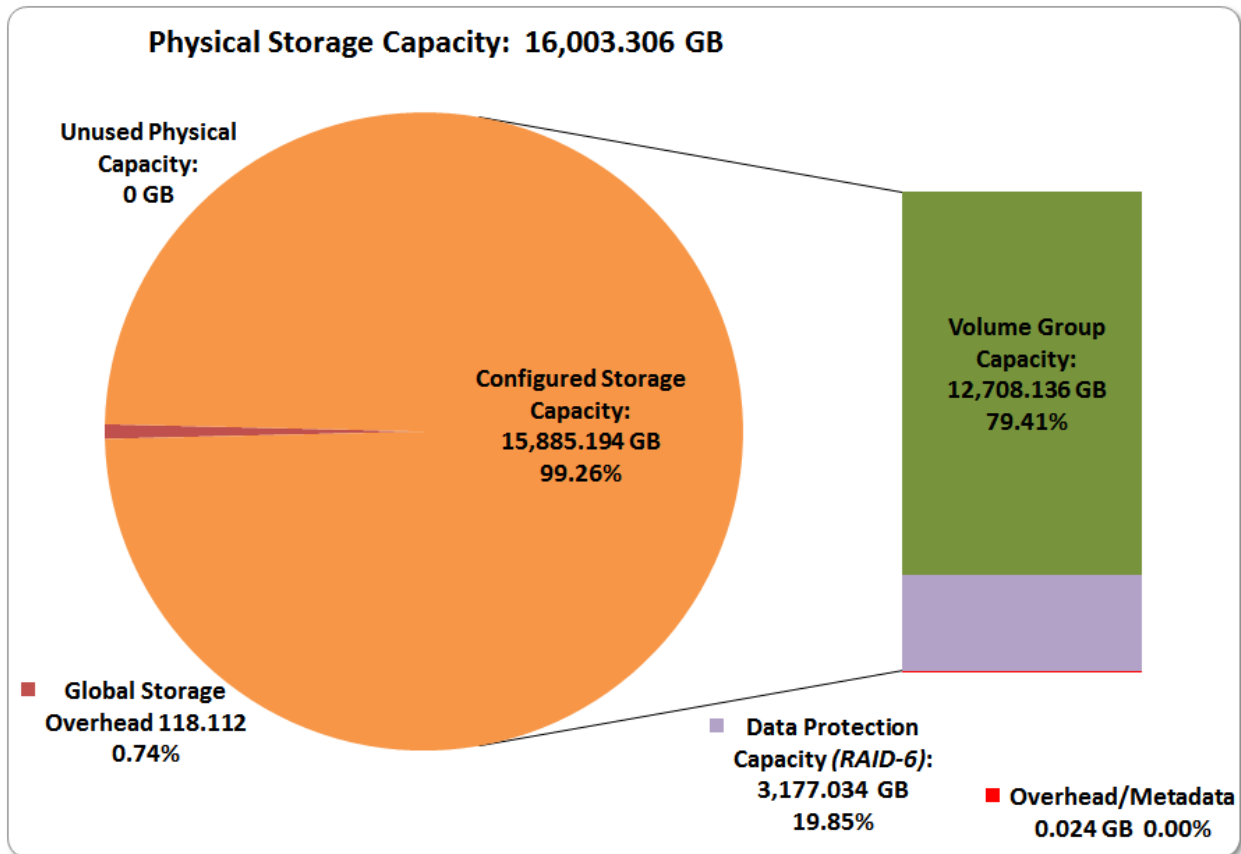

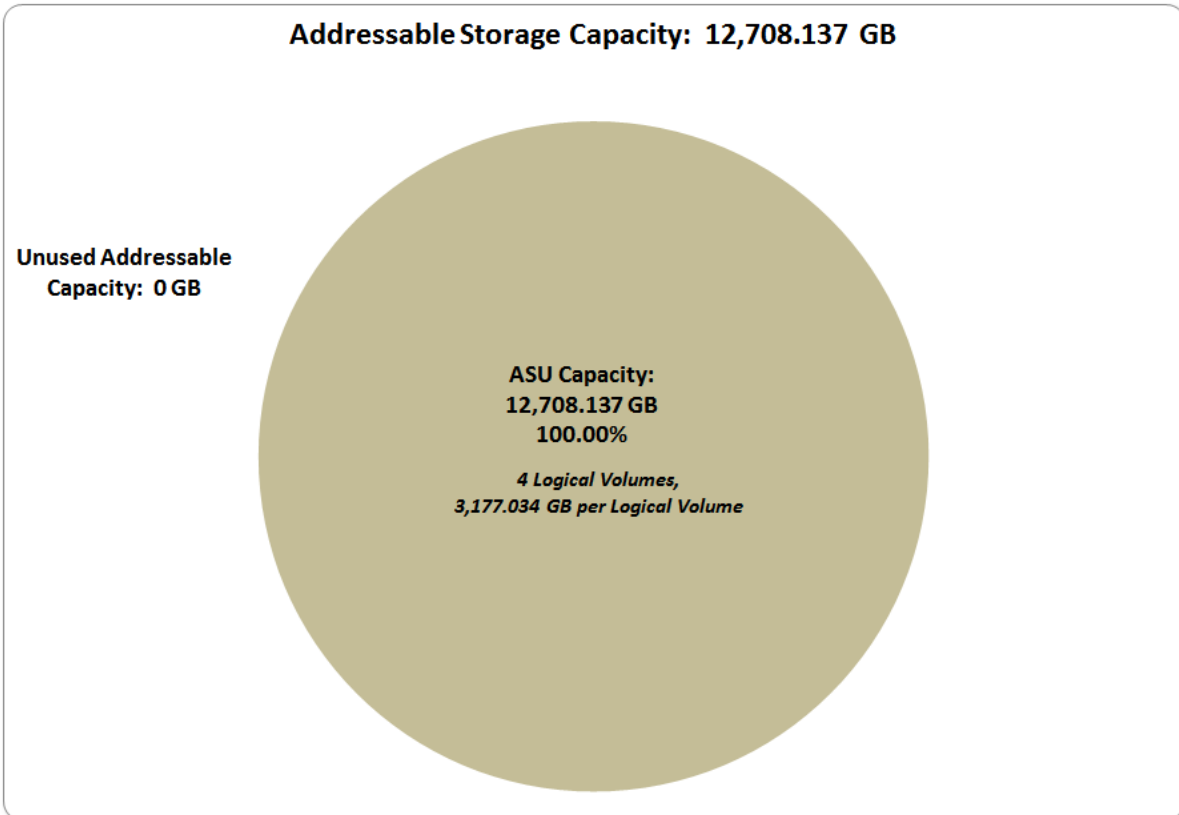
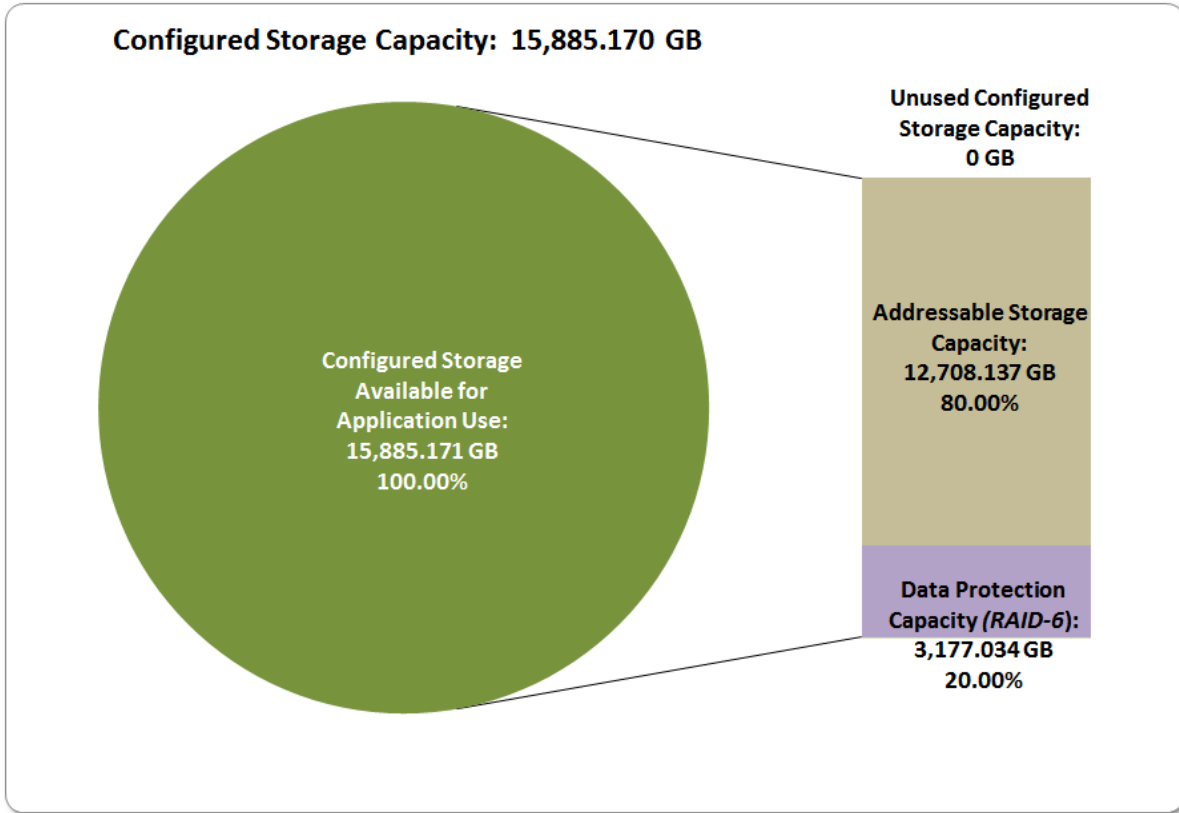

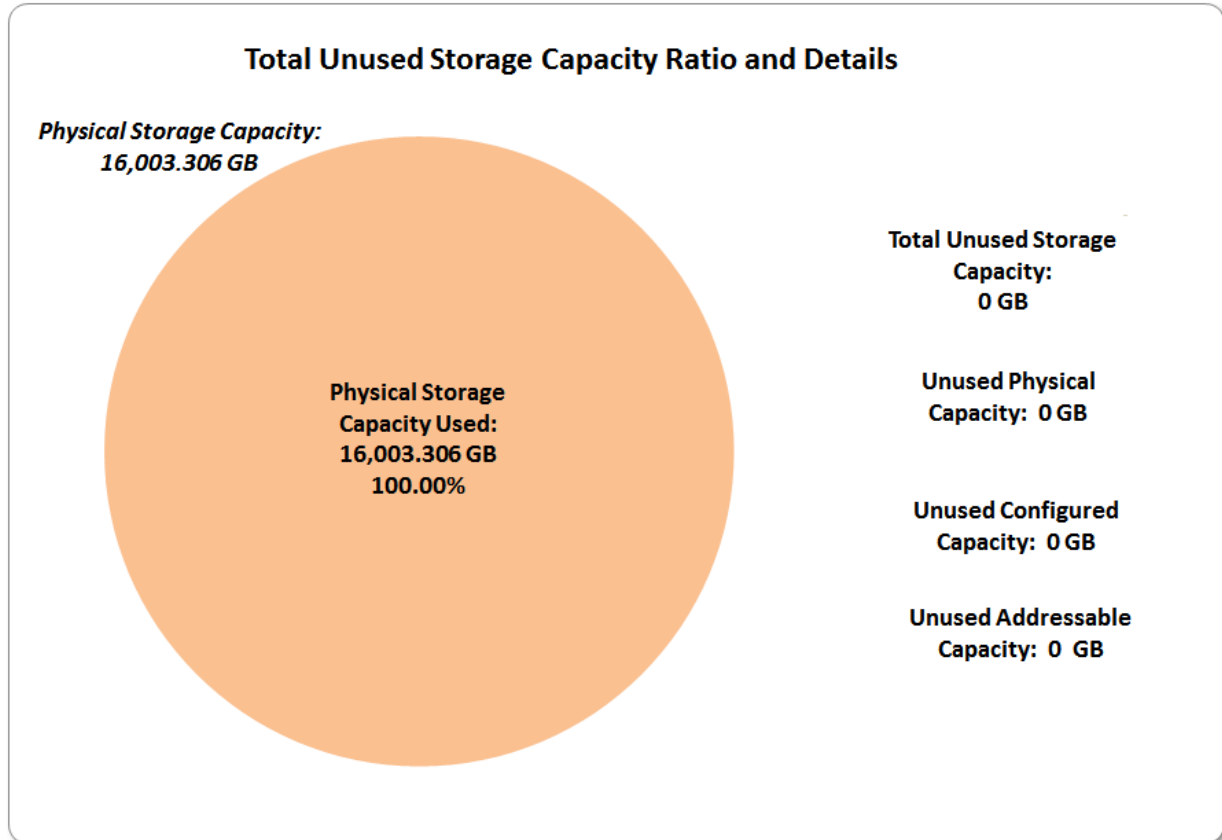

Storage Capacity Utilization

Clause 10.6.8.2

The FDR will include a table illustrating the storage capacity utilization values defined for Application Utilization (Clause 2.8.1), Protected Application Utilization (Clause 2.8.2), and Unused Storage Ratio (Clause 2.8.3).

Clause 2.8.1

Application Utilization is defined as Total ASU Capacity divided by Physical Storage Capacity.

Clause 2.8.2

Protected Application Utilization is defined as (Total ASU Capacity plus total Data Protection Capacity minus unused Data Protection Capacity) divided by Physical Storage Capacity.

Clause 2.8.3

Unused Storage Ratio is defined as Total Unused Capacity divided by Physical Storage Capacity and may not exceed 45%.

SPC-2 Storage Capacity Utilization	
Application Utilization	79.41%
Protected Application Utilization	99.26%
Unused Storage Ratio	0.00%

Logical Volume Capacity and ASU Mapping

Clause 10.6.8.3

A table illustrating the capacity of the Application Storage Unit (ASU) and the mapping of Logical Volumes to ASU will be provided in the FDR. Capacity must be stated in gigabytes (GB) as a value with a minimum of two digits to the right of the decimal point. Each Logical Volume will be sequenced in the table from top to bottom per its position in the contiguous address space of the ASU. Each Logical Volume entry will list its total capacity, the portion of that capacity used for the ASU, and any unused capacity.

Logical Volume (LV) Capacity and Mapping			
ASU (12,708.137 GB)			
	Total Capacity (GB)	Capacity Used (GB)	Capacity Unused (GB)
4 Logical Volumes	3,177.034 per LV	3,177.034 per LV	0.000 per LV

See the Storage Definition (sd) entries in [Appendix D: SPC-2 Workload Generator Storage Commands and Parameter](#) Files on page [70](#) for more detailed configuration information.

SPC-2 BENCHMARK EXECUTION RESULTS

This portion of the Full Disclosure Report documents the results of the various SPC-2 Tests, Test Phases, Test Run Sequences, and Test Runs. An [SPC-2 glossary](#) on page [61](#) contains definitions of terms specific to the SPC-2 Data Repository.

In each of the following sections of this document, the appropriate Full Disclosure Report requirement, from the SPC-2 benchmark specification, is stated in italics followed by the information to fulfill the stated requirement.

SPC-2 Tests, Test Phases, Test Run Sequences, and Test Runs

The SPC-2 benchmark consists of the following Tests, Test Phases, Test Run Sequences, and Test Runs:

- **Data Persistence Test**
 - Data Persistence Test Run 1
 - Data Persistence Test Run 2
- **Large File Processing Test**
 - WRITE ONLY Test Phase
 - Test Run Sequence 1
 - ✓ Test Run 1 – 1024 KiB Transfer – maximum number of Streams
 - ✓ Test Run 2 – 1024 KiB Transfer – 50% of Test Run 1’s Streams value
 - ✓ Test Run 3 – 1024 KiB Transfer – 25% of Test Run 1’s Streams value
 - ✓ Test Run 4 – 1024 KiB Transfer – 12.5% of Test Run 1’s Streams value
 - ✓ Test Run 5 – 1024 KiB Transfer – single (1) Stream
 - Test Run Sequence 2
 - ✓ Test Run 6 – 256 KiB Transfer – maximum number of Streams
 - ✓ Test Run 7 – 256 KiB Transfer – 50% of Test Run 6’s Streams value
 - ✓ Test Run 8 – 256 KiB Transfer – 25% of Test Run 6’s Streams value
 - ✓ Test Run 9 – 256 KiB Transfer – 12.5% of Test Run 6’s Streams value
 - ✓ Test Run 10 – 256 KiB Transfer – single (1) Stream
 - READ-WRITE Test Phase
 - Test Run Sequence 3
 - ✓ Test Run 11 – 1024 KiB Transfer – maximum number of Streams
 - ✓ Test Run 12 – 1024 KiB Transfer – 50% of Test Run 11’s Streams value
 - ✓ Test Run 13 – 1024 KiB Transfer – 25% of Test Run 11’s Streams value
 - ✓ Test Run 14 – 1024 KiB Transfer – 12.5% of Test Run 11’s Streams value
 - ✓ Test Run 15 – 1024 KiB Transfer – single (1) Stream
 - Test Run Sequence 4
 - ✓ Test Run 16 – 256 KiB Transfer – maximum number of Streams
 - ✓ Test Run 17 – 256 KiB Transfer – 50% of Test Run 16’s Streams value
 - ✓ Test Run 18 – 256 KiB Transfer – 25% of Test Run 16’s Streams value
 - ✓ Test Run 19 – 256 KiB Transfer – 12.5% of Test Run 16’s Streams value
 - ✓ Test Run 20 – 256 KiB Transfer – single (1) Stream
 - READ ONLY Test Phase
 - Test Run Sequence 5
 - ✓ Test Run 21 – 1024 KiB Transfer – maximum number of Streams

- ✓ Test Run 22 – 1024 KiB Transfer – 50% of Test Run 21’s Streams value
- ✓ Test Run 23 – 1024 KiB Transfer – 25% of Test Run 21’s Streams value
- ✓ Test Run 24 – 1024 KiB Transfer – 12.5% of Test Run 21’s Streams value
- ✓ Test Run 25 – 1024 KiB Transfer – single (1) Stream
- Test Run Sequence 6
 - ✓ Test Run 26 – 256 KiB Transfer – maximum number of Streams
 - ✓ Test Run 27 – 256 KiB Transfer – 50% of Test Run 26’s Streams value
 - ✓ Test Run 28 – 256 KiB Transfer – 25% of Test Run 26’s Streams value
 - ✓ Test Run 29 – 256 KiB Transfer – 12.5% of Test Run 26’s Streams value
 - ✓ Test Run 30 – 256 KiB Transfer – single (1) Stream
- **Large Database Query Test**
 - 1024 KIB TRANSFER SIZE Test Phase
 - Test Run Sequence 1
 - ✓ Test Run 1 – 4 I/O Requests Outstanding – maximum number of Streams
 - ✓ Test Run 2 – 4 I/O Requests Outstanding – 50% of Test Run 1’s Streams value
 - ✓ Test Run 3 – 4 I/O Requests Outstanding – 25% of Test Run 1’s Streams value
 - ✓ Test Run 4 – 4 I/O Requests Outstanding – 12.5% of Test Run 1’s Streams value
 - ✓ Test Run 5 – 4 I/O Requests Outstanding – single (1) Stream
 - Test Run Sequence 2
 - ✓ Test Run 6 – 1 I/O Request Outstanding – maximum number of Streams
 - ✓ Test Run 7 – 1 I/O Request Outstanding – 50% of Test Run 6’s Streams value
 - ✓ Test Run 8 – 1 I/O Request Outstanding – 25% of Test Run 6’s Streams value
 - ✓ Test Run 9 – 1 I/O Request Outstanding – 12.5% of Test Run 6’s Streams value
 - ✓ Test Run 10 – 1 I/O Request Outstanding – single (1) Stream
 - 64 KIB TRANSFER SIZE Test Phase
 - Test Run Sequence 3
 - ✓ Test Run 11 – 4 I/O Requests Outstanding – maximum number of Streams
 - ✓ Test Run 12 – 4 I/O Requests Outstanding – 50% of Test Run 11’s Streams value
 - ✓ Test Run 13 – 4 I/O Requests Outstanding – 25% of Test Run 11’s Streams value
 - ✓ Test Run 14 – 4 I/O Requests Outstanding – 12.5% of Test Run 11’s Streams value
 - ✓ Test Run 15 – 4 I/O Requests Outstanding – single (1) Stream
 - Test Run Sequence 4
 - ✓ Test Run 16 – 1 I/O Request Outstanding – maximum number of Streams
 - ✓ Test Run 17 – 1 I/O Request Outstanding – 50% of Test Run 16’s Streams value
 - ✓ Test Run 18 – 1 I/O Request Outstanding – 25% of Test Run 16’s Streams value
 - ✓ Test Run 19 – 1 I/O Request Outstanding – 12.5% of Test Run 16’s Streams value
 - ✓ Test Run 20 – 1 I/O Request Outstanding – single (1) Stream
- **Video on Demand Delivery Test**
 - Video on Demand Delivery Test Run

Each Test is an atomic unit that must be executed from start to finish before any other Test, Test Phase, or Test Run may be executed. The Tests may be executed in any sequence.

The results from each Test, Test Phase, and Test Run are listed below along with a more detailed explanation of each component.

Large File Processing Test

Clause 6.4.3.1

The Large File Processing Test consists of the I/O operations associated with the type of applications, in a wide range of fields, which require simple sequential processing of one or more large files. Specific examples of those types of applications include scientific computing and large-scale financial processing

Clause 6.4.3.2

The Large File Processing Test has three Test Phases, which shall be executed in the following uninterrupted sequence:

1. *WRITE ONLY*
2. *READ-WRITE*
3. *READ ONLY*

The BC shall not be restarted or manually disturbed, altered, or adjusted during the execution of the Large File Processing Test. If power is lost to the BC during this Test all results shall be rendered invalid and the Test re-run in its entirety.

Clause 10.6.9.1

The Full Disclosure Report will contain the following content for the Large File Processing Test:

1. *A listing of the SPC-2 Workload Generator commands and parameters used to execute each of the Test Runs in the Large File Processing Test.*
2. *The human readable SPC-2 Test Results File for each of the Test Runs in the Large File Processing Test.*
3. *The following three tables:*
 - *Average Data Rate: The average Data Rate, in MB per second for the Measurement Interval of each Test Run in the Large File Processing Test.*
 - *Average Data Rate per Stream: The average Data Rate per Stream, in MB per second, for the Measurement Interval of each Test Run in the Large File Processing Test.*
 - *Average Response Time: The average response time, in milliseconds (ms), for the Measurement Interval of each Test Run in the Large File Processing Test.*
4. *Average Data Rate, Average Data Rate per Stream and Average Response Time graphs as defined in Clauses 10.1.1, 10.1.2 and 10.1.3.*

SPC-2 Workload Generator Commands and Parameters

The SPC-2 Workload Generator commands and parameters for the Large File Processing Test Runs are documented in [Appendix E: SPC-2 Workload Generator Execution Commands and Parameters](#) on Page 74.

SPC-2 Test Results File

A link to the SPC-2 Test Results file generated from the Large File Processing Test Runs is listed below.

[SPC-2 Large File Processing Test Results File](#)

SPC-2 Large File Processing Average Data Rates (MB/s)

The average Data Rate (MB/s) for each Test Run in the three Test Phases of the SPC-2 Large File Processing Test is listed in the table below as well as illustrated in the following graph.

Test Run Sequence	1 Stream	12 Streams	24 Streams	48 Streams	96 Streams
Write 1024KiB	365.99	3,558.05	5,346.88	6,549.58	6,790.89
Write 256KiB	327.76	3,251.45	5,109.53	6,493.59	6,562.37
Read/Write 1024KiB	563.85	5,519.90	8,922.51	10,254.29	10,179.46
Read/Write 256KiB	504.40	4,878.80	8,253.16	10,307.60	10,685.71
Read 1024KiB	1,119.23	10,226.90	13,095.53	13,184.96	13,185.58
Read 256KiB	1,000.52	9,534.70	12,712.19	12,712.62	12,716.91

SPC-2 Large File Processing Average Data Rates Graph

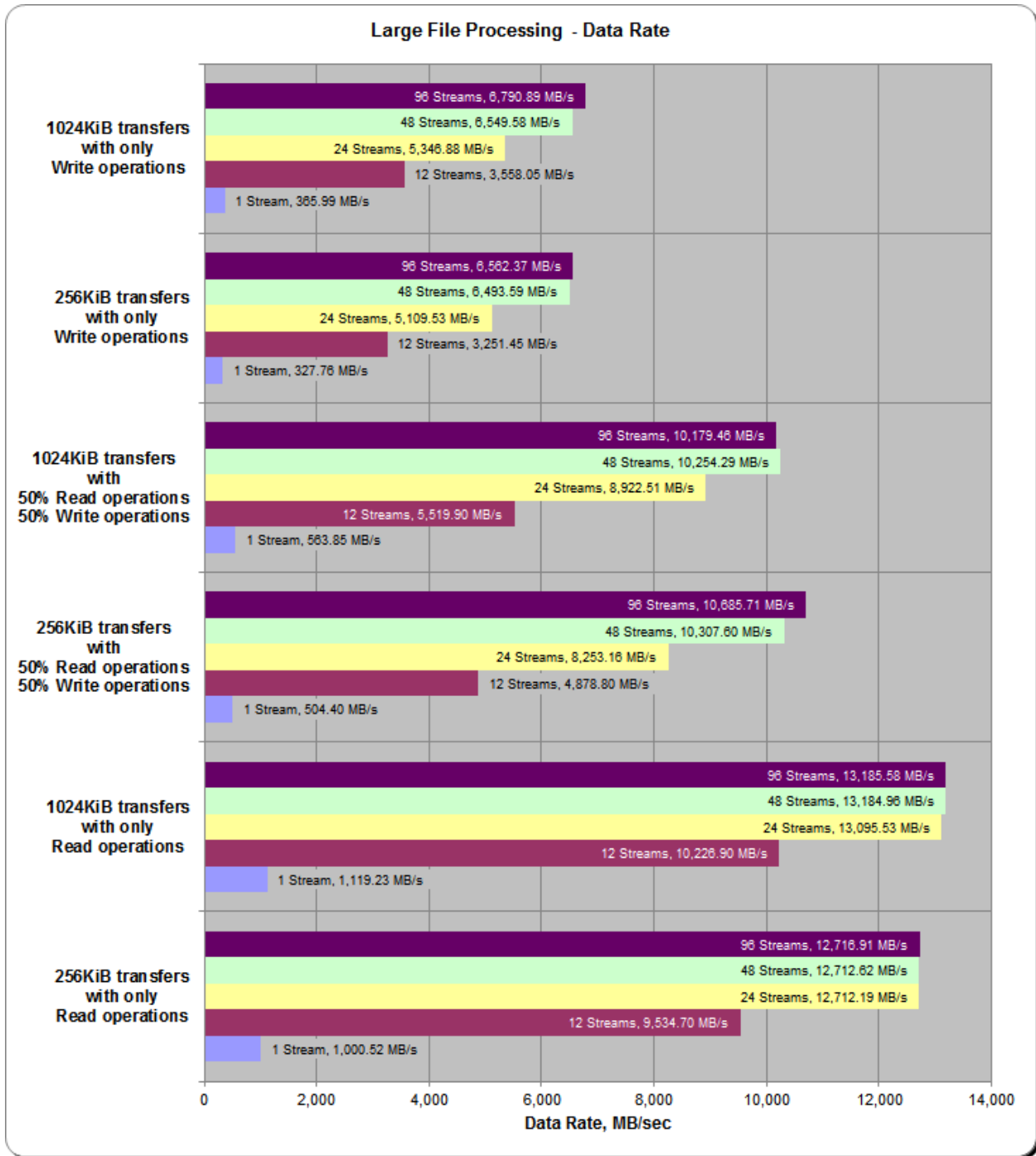

SPC-2 Large File Processing Average Data Rate per Stream

The average Data Rate per Stream for each Test Run in the three Test Phases of the SPC-2 Large File Processing Test is listed in the table below as well as illustrated in the following graph.

Test Run Sequence	1 Stream	12 Streams	24 Streams	48 Streams	96 Streams
Write 1024KiB	365.99	296.50	222.79	136.45	70.74
Write 256KiB	327.76	270.95	212.90	135.28	68.36
Read/Write 1024KiB	563.85	459.99	371.77	213.63	106.04
Read/Write 256KiB	504.40	406.57	343.88	214.74	111.31
Read 1024KiB	1,119.23	852.24	545.65	274.69	137.35
Read 256KiB	1,000.52	794.56	529.67	264.85	132.47

SPC-2 Large File Processing Average Data Rate per Stream Graph

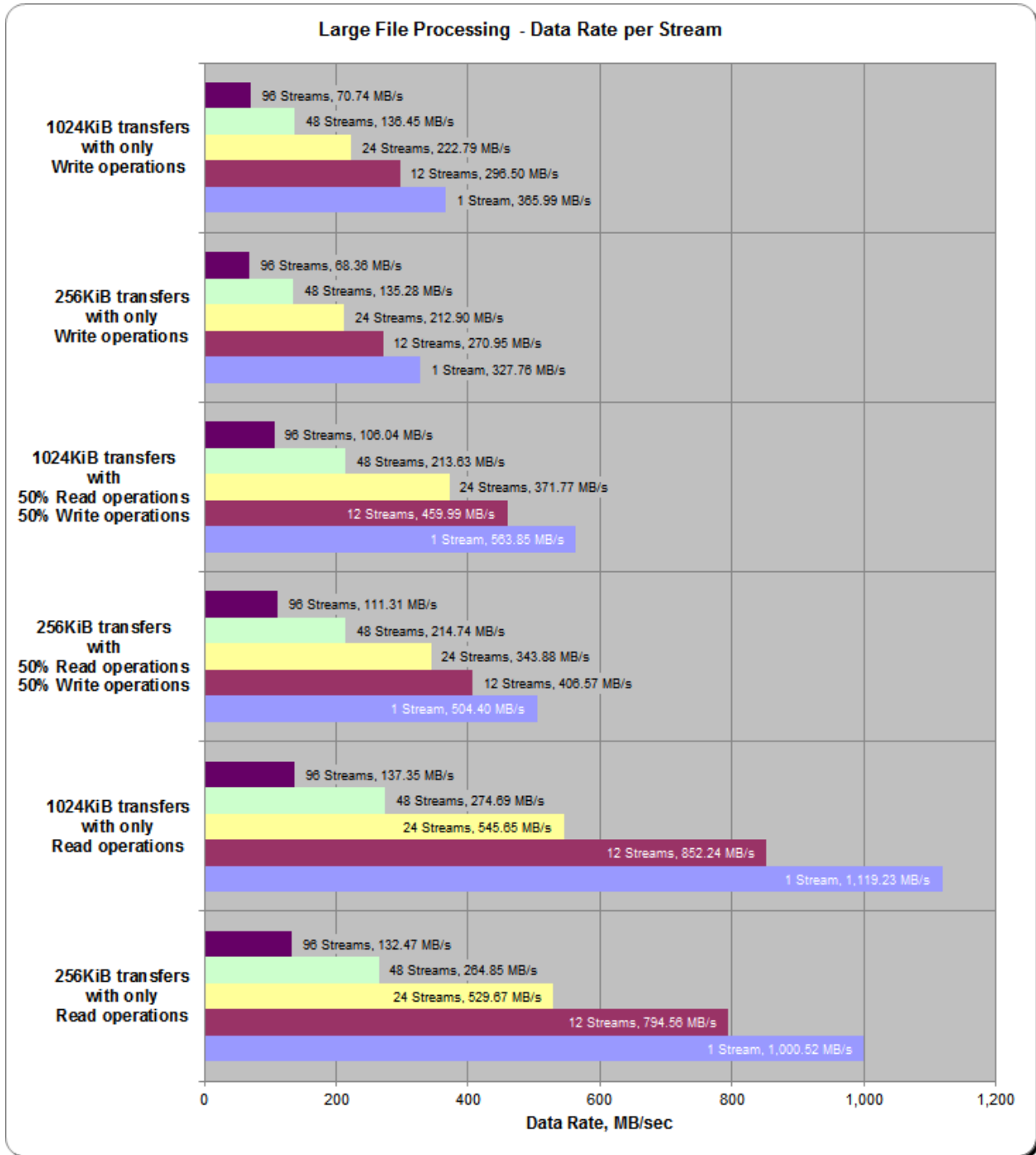

SPC-2 Large File Processing Average Response Time

The average Response Time, milliseconds (ms), for each Test Run in the three Test Phases of the SPC-2 Large File Processing Test is listed in the table below as well as illustrated in the following graph.

Test Run Sequence	1 Stream	12 Streams	24 Streams	48 Streams	96 Streams
Write 1024KiB	2.87	3.54	4.71	7.68	14.82
Write 256KiB	0.80	0.97	1.23	1.94	3.84
Read/Write 1024KiB	1.86	2.28	2.82	4.91	9.89
Read/Write 256KiB	0.52	0.64	0.76	1.22	2.35
Read 1024KiB	0.94	1.23	1.92	3.82	7.63
Read 256KiB	0.26	0.33	0.49	0.99	1.98

SPC-2 Large File Processing Average Response Time Graph

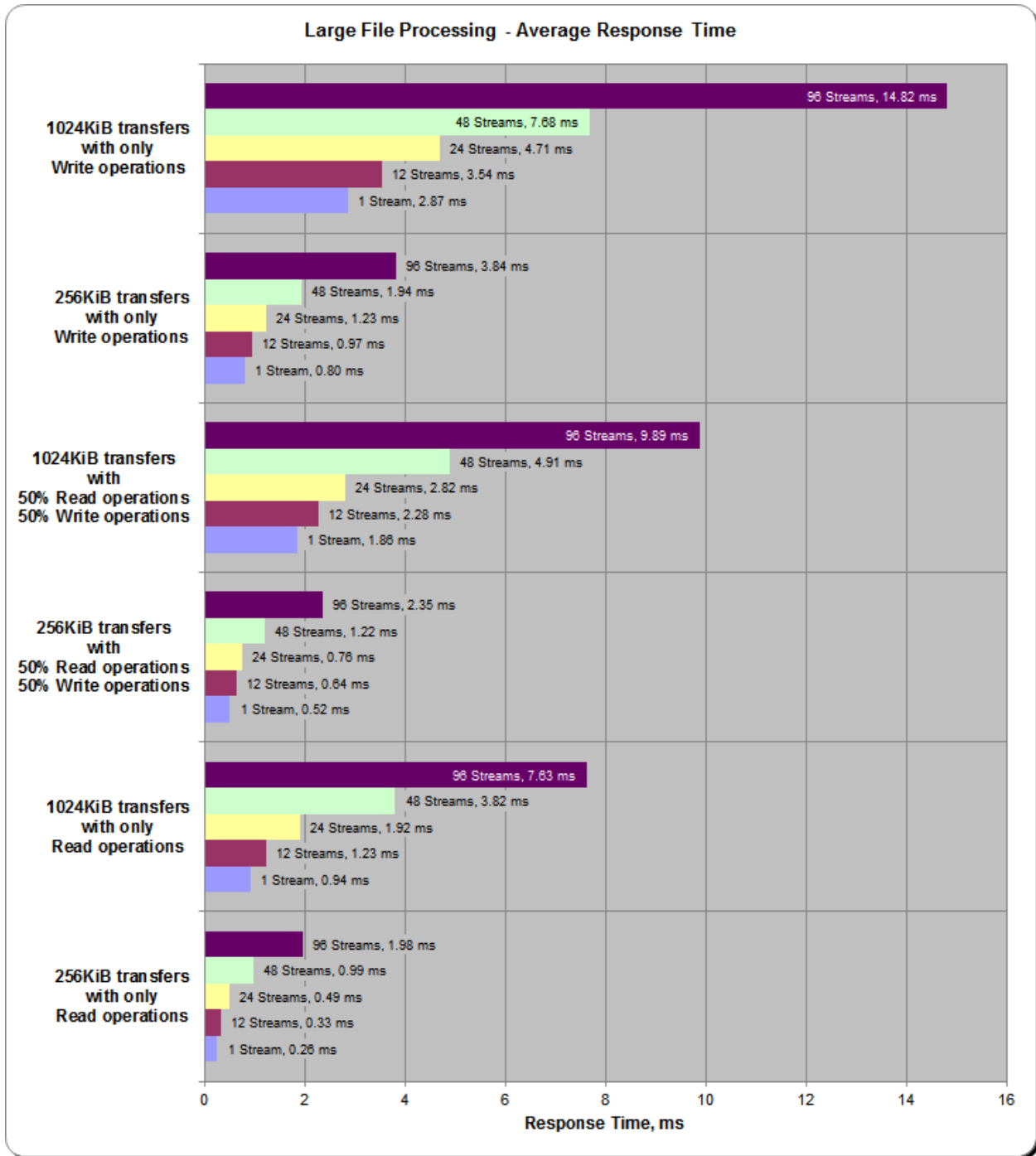

Large File Processing Test – WRITE ONLY Test Phase

Clause 10.6.9.1.1

1. *A table that will contain the following information for each "WRITE ONLY, 1024 KiB Transfer Size" Test Run:*
 - *The number of Streams specified.*
 - *The Average Data Rate, Average Data Rate per Stream, and Average Response Time reported at five second intervals.*
2. *Average Data Rate by Intervals, Average Data Rate per Stream by Intervals, and Average Response Time by Intervals graphs for the "WRITE ONLY, 1024 KiB Transfer Size" Test Runs as specified in Clauses 10.1.4 – 10.1.6.*
3. *A table that will contain the following information for each "WRITE ONLY, 256 KiB Transfer Size" Test Run:*
 - *The number of Streams specified.*
 - *The Average Data Rate, Average Data Rate per Stream, and Average Response Time reported at five second intervals.*
4. *Average Data Rate by Intervals, Average Data Rate per Stream by Intervals, and Average Response Time by Intervals graphs for the "WRITE ONLY, 256 KiB Transfer Size" Test Runs as specified in Clauses 10.1.4 – 10.1.6.*

A hyperlink for each of the above tables and graphs may appear in the FDR to provide access to the table or graph.

A hyperlink to a table with the SPC-2 "Large File Processing/WRITE ONLY/1024 KiB Transfer Size" Test Run data appears on the next page. That entry is followed by hyperlinks to graphs illustrating the average Data Rate, average Data Rate per Stream, and average Response Time produced by the same Test Runs. The table and graphs present the data at five-second intervals.

Immediately following the above SPC-2 "Large File Processing/WRITE ONLY/1024 KiB Transfer Size" entries will be hyperlinks for SPC-2 "Large File Processing/WRITE ONLY/256 KiB Transfer Size" table and graphs. The table contains the Test Run data and the graphs illustrate the average Data Rate, average Data Rate per Stream, and average Response Time produced by the Test Runs.

SPC-2 “Large File Processing/WRITE ONLY/1024 KiB Transfer Size” Test Run Data

[SPC-2 “Large File Processing/WRITE ONLY/1024 KiB Transfer Size” Test Run Data Tables: Ramp-Up, Measurement Interval, Run-Out, and Ramp-Down Periods](#)
(3 pages)

SPC-2 “Large File Processing/WRITE ONLY/1024 KiB Transfer Size” Graphs

Average Data Rate – Complete Test Run

Average Data Rate – Measurement Interval (MI) Only

Average Data Rate per Stream

Average Response Time

[SPC-2 “Large File Processing/WRITE ONLY/1024 KiB Transfer Size” graphs](#)
(four pages, 1 graph per page)

SPC-2 “Large File Processing/WRITE ONLY/256 KiB Transfer Size” Test Run Data

[SPC-2 “Large File Processing/WRITE ONLY/256 KiB Transfer Size” Test Run Data Tables: Ramp-Up, Measurement Interval, Run-Out, and Ramp-Down Periods](#)
(3 pages)

SPC-2 “Large File Processing/WRITE ONLY/256 KiB Transfer Size” Graphs

Average Data Rate – Complete Test Run

Average Data Rate – Measurement Interval (MI) Only

Average Data Rate per Stream

Average Response Time

[SPC-2 “Large File Processing/WRITE ONLY/256 KiB Transfer Size” graphs](#)
(four pages, 1 graph per page)

Large File Processing Test – READ-WRITE Test Phase

Clause 10.6.9.1.2

1. *A table that will contain the following information for each "READ-WRITE, 1024 KiB Transfer Size" Test Run:*
 - *The number of Streams specified.*
 - *The Average Data Rate, Average Data Rate per Stream, and Average Response Time reported at five second intervals.*
2. *Average Data Rate by Intervals, Average Data Rate per Stream by Intervals, and Average Response Time by Intervals graphs for the "READ-WRITE, 1024 KiB Transfer Size" Test Runs as specified in Clauses 10.1.4 – 10.1.6.*
3. *A table that will contain the following information for each "READ-WRITE, 256 KiB Transfer Size" Test Run:*
 - *The number of Streams specified.*
 - *The Average Data Rate, Average Data Rate per Stream, and Average Response Time reported at five second intervals.*
4. *Average Data Rate by Intervals, Average Data Rate per Stream by Intervals, and Average Response Time by Intervals graphs for the "READ-WRITE, 256 KiB Transfer Size" Test Runs as specified in Clauses 10.1.4 – 10.1.6.*

A hyperlink for each of the above tables and graphs may appear in the FDR to provide access to the table or graph.

A hyperlink to a table with the SPC-2 "Large File Processing/READ-WRITE/1024 KiB Transfer Size" Test Run data appears on the next page. That entry is followed by hyperlinks to graphs illustrating the average Data Rate, average Data Rate per Stream, and average Response Time produced by the same Test Runs. The table and graphs present the data at five-second intervals.

Immediately following the above SPC-2 "Large File Processing/READ-WRITE/1024 KiB Transfer Size" entries will be hyperlinks for SPC-2 "Large File Processing/READ-WRITE/256 KiB Transfer Size" table and graphs. The table contains the Test Run data and the graphs illustrate the average Data Rate, average Data Rate per Stream, and average Response Time produced by the Test Runs.

SPC-2 “Large File Processing/READ-WRITE/1024 KiB Transfer Size” Test Run Data

[SPC-2 “Large File Processing/READ-WRITE/1024 KiB Transfer Size” Test Run Data Tables: Ramp-Up, Measurement Interval, Run-Out, and Ramp-Down Periods](#)
(3 pages)

SPC-2 “Large File Processing/READ-WRITE/1024 KiB Transfer Size” Graphs

Average Data Rate – Complete Test Run

Average Data Rate – Measurement Interval (MI) Only

Average Data Rate per Stream

Average Response Time

[SPC-2 “Large File Processing/READ-WRITE/1024 KiB Transfer Size” graphs](#)
(four pages, 1 graph per page)

SPC-2 “Large File Processing/READ-WRITE/256 KiB Transfer Size” Test Run Data

[SPC-2 “Large File Processing/READ-WRITE/256 KiB Transfer Size” Test Run Data Tables: Ramp-Up, Measurement Interval, Run-Out, and Ramp-Down Periods](#)
(3 pages)

SPC-2 “Large File Processing/READ-WRITE/256 KiB Transfer Size” Graphs

Average Data Rate – Complete Test Run

Average Data Rate – Measurement Interval (MI) Only

Average Data Rate per Stream

Average Response Time

[SPC-2 “Large File Processing/READ-WRITE/256 KiB Transfer Size” graphs](#)
(four pages, 1 graph per page)

Large File Processing Test – READ ONLY Test Phase

Clause 10.6.9.1.3

1. A table that will contain the following information for each "READ ONLY, 1024 KiB Transfer Size" Test Run:
 - The number of Streams specified.
 - The Average Data Rate, Average Data Rate per Stream, and Average Response Time reported at five second intervals.
2. Average Data Rate by Intervals, Average Data Rate per Stream by Intervals, and Average Response Time by Intervals graphs for the "READ ONLY, 1024 KiB Transfer Size" Test Runs as specified in Clauses 10.1.4 – 10.1.6.
3. A table that will contain the following information for each "READ ONLY, 256 KiB Transfer Size" Test Run:
 - The number of Streams specified.
 - The Average Data Rate, Average Data Rate per Stream, and Average Response Time reported at five second intervals.
4. Average Data Rate by Intervals, Average Data Rate per Stream by Intervals, and Average Response Time by Intervals graphs for the "READ ONLY, 256 KiB Transfer Size" Test Runs as specified in Clauses 10.1.4 – 10.1.6.

A hyperlink for each of the above tables and graphs may appear in the FDR to provide access to the table or graph.

A hyperlink to a table with the SPC-2 "Large File Processing/READ ONLY/1024 KiB Transfer Size" Test Run data appears on the next page. That entry is followed by hyperlinks to graphs illustrating the average Data Rate, average Data Rate per Stream, and average Response Time produced by the same Test Runs. The table and graphs present the data at five-second intervals.

Immediately following the above SPC-2 "Large File Processing/READ ONLY/1024 KiB Transfer Size" entries will be hyperlinks for SPC-2 "Large File Processing/READ ONLY/256 KiB Transfer Size" table and graphs. The table contains the Test Run data and the graphs illustrate the average Data Rate, average Data Rate per Stream, and average Response Time produced by the Test Runs.

SPC-2 “Large File Processing/READ ONLY/1024 KiB Transfer Size” Test Run Data

[SPC-2 “Large File Processing/READ ONLY/1024 KiB Transfer Size” Test Run Data Tables: Ramp-Up, Measurement Interval, Run-Out, and Ramp-Down Periods](#)
(3 pages)

SPC-2 “Large File Processing/READ ONLY/1024 KiB Transfer Size” Graphs

Average Data Rate – Complete Test Run

Average Data Rate – Measurement Interval (MI) Only

Average Data Rate per Stream

Average Response Time

[SPC-2 “Large File Processing/READ ONLY/1024 KiB Transfer Size” graphs](#)
(four pages, 1 graph per page)

SPC-2 “Large File Processing/READ ONLY/256 KiB Transfer Size” Test Run Data

[SPC-2 “Large File Processing/READ ONLY/256 KiB Transfer Size” Test Run Data Tables: Ramp-Up, Measurement Interval, Run-Out, and Ramp-Down Periods](#)
(3 pages)

SPC-2 “Large File Processing/READ ONLY/256 KiB Transfer Size” Graphs

Average Data Rate – Complete Test Run

Average Data Rate – Measurement Interval (MI) Only

Average Data Rate per Stream

Average Response Time

[SPC-2 “Large File Processing/READ ONLY/256 KiB Transfer Size” graphs](#)
(four pages, 1 graph per page)

Large Database Query Test

Clause 6.4.4.1

The Large Database Query Test is comprised of a set of I/O operations representative of scans or joins of large relational tables such as those performed for data mining or business intelligence.

Clause 6.4.4.2

The Large Database Query Test has two Test Phases, which shall be executed in the following uninterrupted sequence:

- 1. 1024 KiB TRANSFER SIZE*
- 2. 64 KiB TRANSFER SIZE*

The BC shall not be restarted or manually disturbed, altered, or adjusted during the execution of the Large File Processing Test. If power is lost to the BC during this Test all results shall be rendered invalid and the Test re-run in its entirety.

Clause 10.6.9.2

The Full Disclosure Report will contain the following content for the Large Database Query Test:

- 1. A listing of the SPC-2 Workload Generator commands and parameters used to execute each of the Test Runs in the Large Database Query Test.*
- 2. The human readable SPC-2 Test Results File for each of the Test Runs in the Large Database Query Test.*
- 3. A table that contains the following information for each Test Run in the two Test Phases of the Large Database Query Test:*
 - Average Data Rate: The average Data Rate, in MB per second for the Measurement Interval of each Test Run in the Large Database Query Test.*
 - Average Data Rate per Stream: The average Data Rate per Stream, in MB per second, for the Measurement Interval of each Test Run in the Large Database Query Test.*
 - Average Response Time: The average response time, in milliseconds (ms), for the Measurement Interval of each Test Run in the Large Database Query Test.*
- 4. Average Data Rate, Average Data Rate per Stream and Average Response time graphs as defined in Clauses 10.1.1, 10.1.2 and 10.1.3.*

SPC-2 Workload Generator Commands and Parameters

The SPC-2 Workload Generator commands and parameters for the Large Database Query Test Runs are documented in [Appendix E: SPC-2 Workload Generator Execution Commands and Parameters](#) on Page [74](#).

SPC-2 Test Results File

A link to the SPC-2 Test Results file generated from the Large Database Query Test Runs is listed below.

[SPC-2 Large Database Query Test Results File](#)

SPC-2 Large Database Query Average Data Rates (MB/s)

The average Data Rate (MB/s) for each Test Run in the two Test Phases of the SPC-2 Large Database Query Test is listed in the table below as well as illustrated in the following graph.

Test Run Sequence	1 Stream	12 Streams	24 Streams	48 Streams	96 Streams
1024KiB w/ 4 IOs/Stream	3,120.78	13,281.26	13,319.43	13,319.93	13,303.28
1024KiB w/ 1 IO/Stream	1,099.61	10,079.46	13,129.83	13,308.90	13,292.79
64KiB w/ 4 IOs/Stream	2,279.63	12,740.89	12,771.73	12,761.38	12,756.95
64KiB w/ 1 IO/Stream	687.99	6,907.82	10,789.27	12,751.35	12,752.32

SPC-2 Large Database Query Average Data Rates Graph

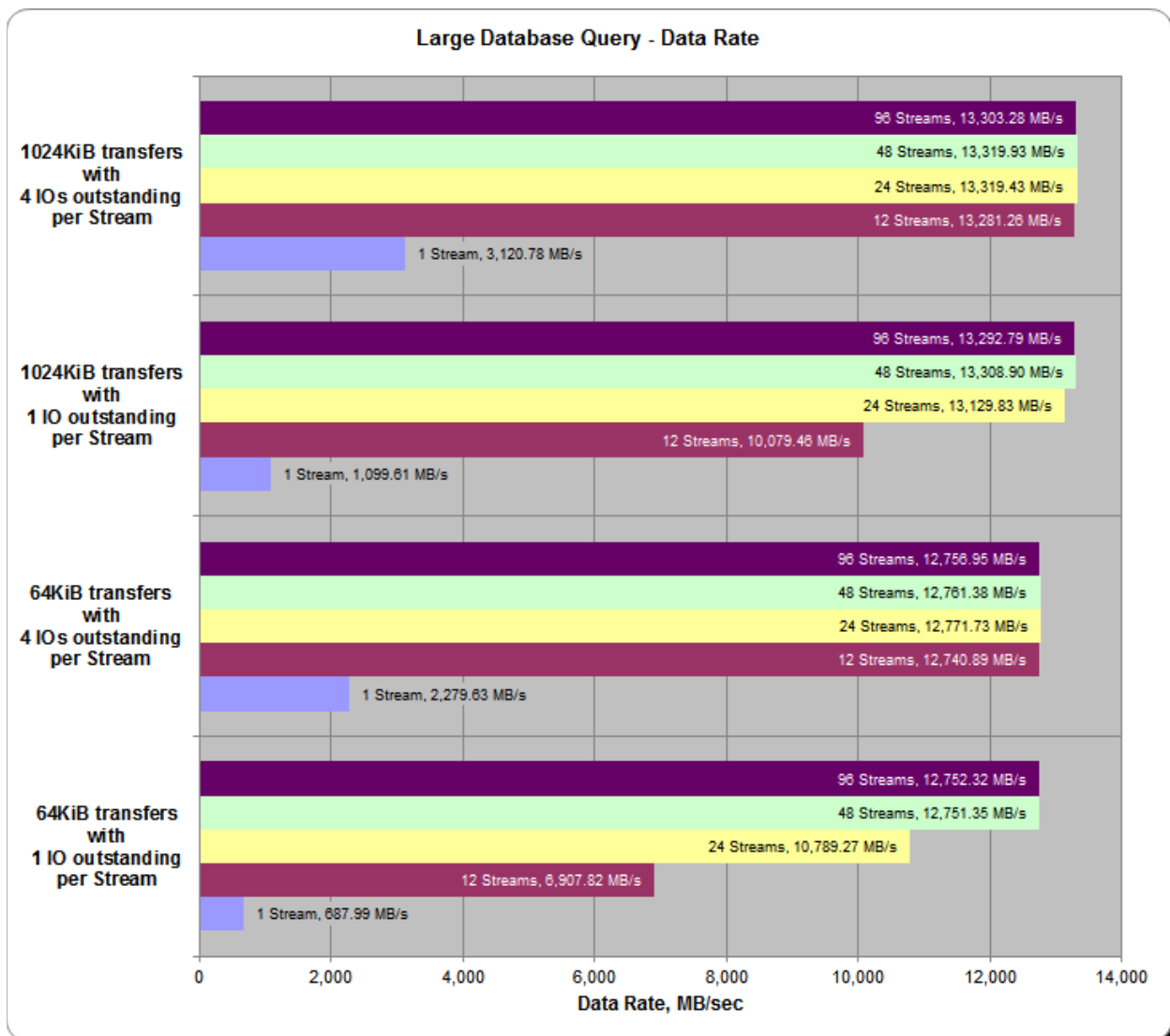

SPC-2 Large Database Query Average Data Rate per Stream

The average Data Rate per Stream for each Test Run in the two Test Phases of the SPC-2 Large Database Query Test is listed in the table below as well as illustrated in the following graph.

Test Run Sequence	1 Stream	12 Streams	24 Streams	48 Streams	96 Streams
1024KiB w/ 4 IOs/Stream	3,120.78	1,106.77	554.98	277.50	138.58
1024KiB w/ 1 IO/Stream	1,099.61	839.96	547.08	277.27	138.47
64KiB w/ 4 IOs/Stream	2,279.63	1,061.74	532.16	265.86	132.88
64KiB w/ 1 IO/Stream	687.99	575.65	449.55	265.65	132.84

SPC-2 Large Database Query Average Data Rate per Stream Graph

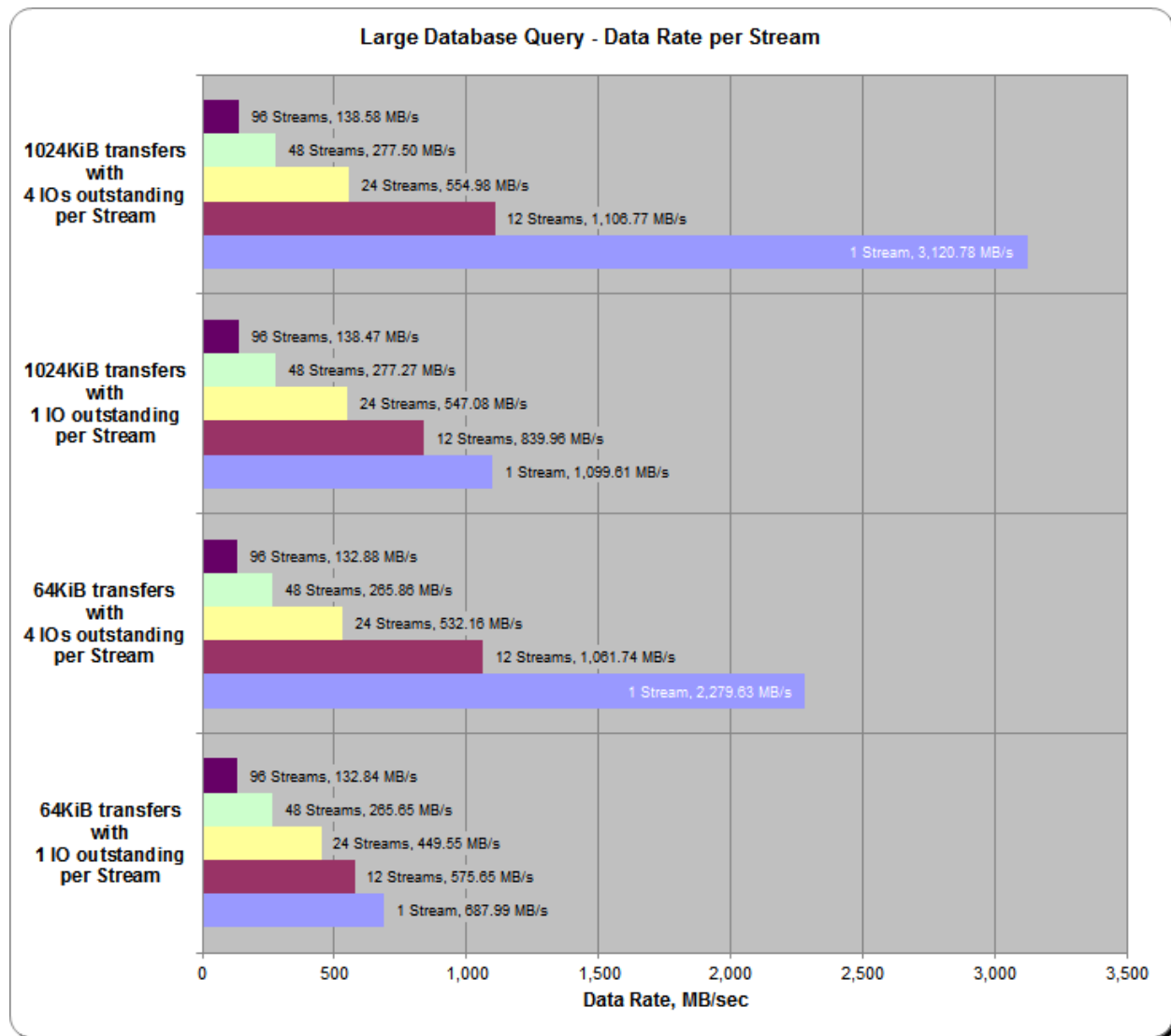

SPC-2 Large Database Query Average Response Time

The average Response Time, in milliseconds, for each Test Run in the two Test Phases of the SPC-2 Large Database Query Test is listed in the table below as well as illustrated in the following graph.

Test Run Sequence	1 Stream	12 Streams	24 Streams	48 Streams	96 Streams
1024KiB w/ 4 IOs/Stream	1.34	3.79	7.56	15.11	30.26
1024KiB w/ 1 IO/Stream	0.95	1.25	1.92	3.78	7.57
64KiB w/ 4 IOs/Stream	0.11	0.25	0.49	0.99	1.97
64KiB w/ 1 IO/Stream	0.09	0.11	0.15	0.25	0.49

SPC-2 Large Database Query Average Response Time Graph

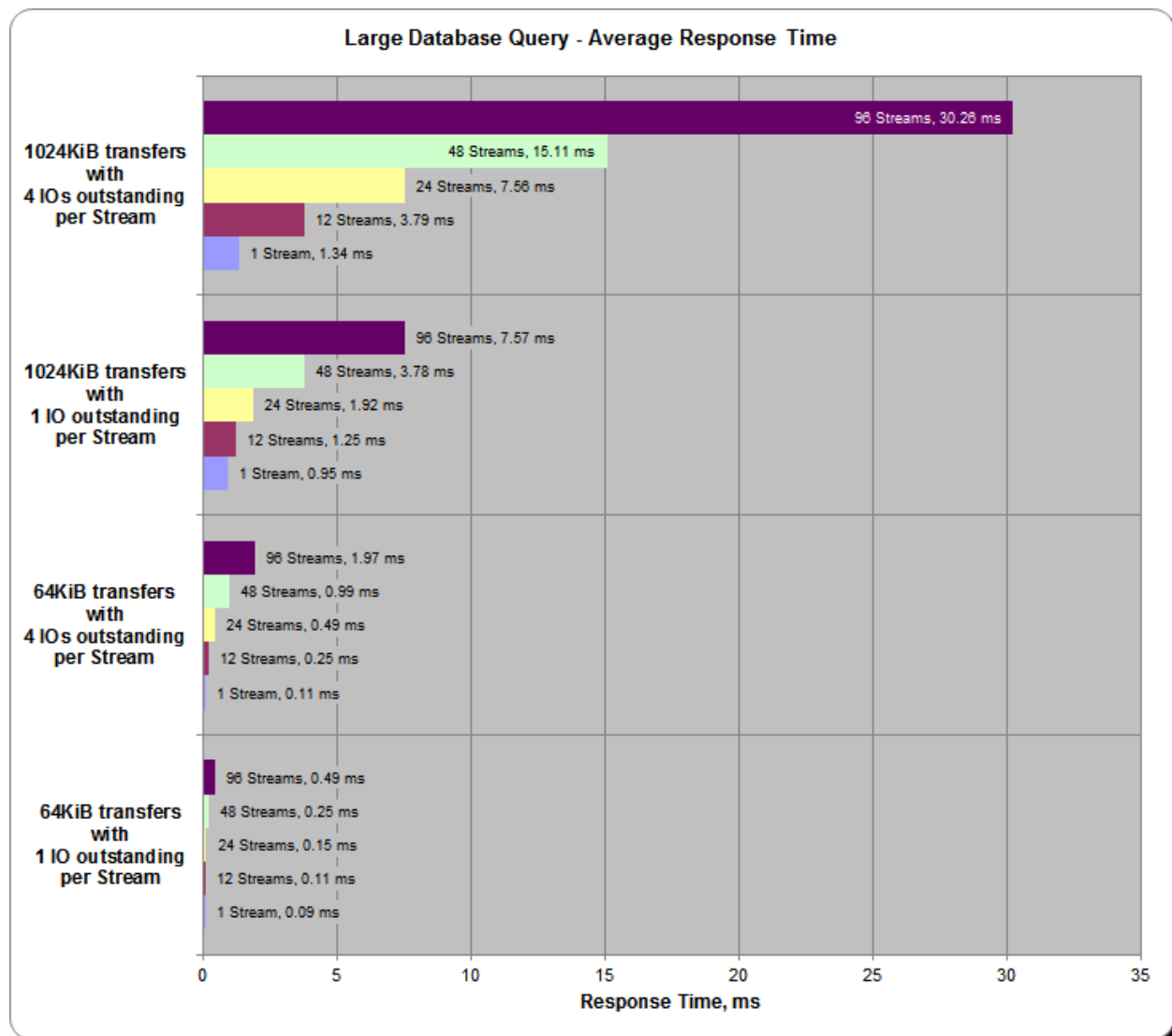

Large Database Query Test – 1024 KiB TRANSFER SIZE Test Phase

Clause 10.6.9.2.1

1. A table that will contain the following information for each "1024 KiB Transfer Size, 4 Outstanding I/Os" Test Run:
 - The number of Streams specified.
 - The Average Data Rate, Average Data Rate per Stream, and Average Response Time reported at five second intervals.
2. Average Data Rate by Intervals, Average Data Rate per Stream by Intervals, and Average Response Time by Intervals graphs for the "1024 KiB Transfer Size, 4 Outstanding I/Os" Test Runs as specified in Clauses 10.1.4 – 10.1.6.
3. A table that will contain the following information for each "1024 KiB Transfer Size, 1 Outstanding I/O" Test Run:
 - The number of Streams specified.
 - The Average Data Rate, Average Data Rate per Stream, and Average Response Time reported at five second intervals.
4. Average Data Rate by Intervals, Average Data Rate per Stream by Intervals, and Average Response Time by Intervals graphs for the "1024 KiB Transfer Size, 1 Outstanding I/O" Test Runs as specified in Clauses 10.1.4 – 10.1.6.

A hyperlink for each of the above tables and graphs may appear in the FDR to provide access to the table or graph.

A hyperlink to a table with the SPC-2 "Large Database Query/1024 KiB TRANSFER SIZE/4 Outstanding I/Os" Test Run data appears on the next page. That entry is followed by hyperlinks to graphs illustrating the average Data Rate, average Data Rate per Stream, and average Response Time produced by the same Test Runs. The table and graphs present the data at five-second intervals.

Immediately following the above SPC-2 "Large Database Query/1024 KiB TRANSFER SIZE/4 Outstanding I/Os" entries will be hyperlinks for SPC-2 "Large Database Query/1024 KiB TRANSFER SIZE/1 Outstanding I/O" table and graphs. The table contains the Test Run data and the graphs illustrate the average Data Rate, average Data Rate per Stream, and average Response Time produced by the Test Runs.

SPC-2 “Large Database Query/1024 KIB TRANSFER SIZE/4 Outstanding I/Os” Test Run Data

[SPC-2 “Large Database Query/1024 KIB TRANSFER SIZE/4 Outstanding I/Os” Test Run Data Tables: Ramp-Up, Measurement Interval, Run-Out, and Ramp-Down Periods](#)

(3 pages)

SPC-2 “Large Database Query/1024 KIB TRANSFER SIZE/4 Outstanding I/Os” Graphs

Average Data Rate – Complete Test Run

Average Data Rate – Measurement Interval (MI) Only

Average Data Rate per Stream

Average Response Time

[SPC-2 “Large Database Query/1024 KIB TRANSFER SIZE/4 Outstanding I/Os” graphs](#)

(four pages, 1 graph per page)

SPC-2 “Large Database Query/1024 KIB TRANSFER SIZE/1 Outstanding I/O” Test Run Data

[SPC-2 “Large Database Query/1024 KIB TRANSFER SIZE/1 Outstanding I/O” Test Run Data Tables: Ramp-Up, Measurement Interval, Run-Out, and Ramp-Down Periods](#)

(3 pages)

SPC-2 “Large Database Query/1024 KIB TRANSFER SIZE/1 Outstanding I/O” Graphs

Average Data Rate – Complete Test Run

Average Data Rate – Measurement Interval (MI) Only

Average Data Rate per Stream

Average Response Time

[SPC-2 “Large Database Query/1024 KIB TRANSFER SIZE/1 Outstanding I/O” graphs](#)

(four pages, 1 graph per page)

Large Database Query Test – 64 KiB TRANSFER SIZE Test Phase

Clause 10.6.9.2.2

1. A table that will contain the following information for each "64 KiB Transfer Size, 4 Outstanding I/Os" Test Run:
 - The number of Streams specified.
 - The Average Data Rate, Average Data Rate per Stream, and Average Response Time reported at five second intervals.
2. Average Data Rate by Intervals, Average Data Rate per Stream by Intervals, and Average Response Time by Intervals graphs for the "64 KiB Transfer Size, 4 Outstanding I/Os" Test Runs as specified in Clauses 10.1.4 – 10.1.6.
3. A table that will contain the following information for each "64 KiB Transfer Size, 1 Outstanding I/O" Test Run:
 - The number of Streams specified.
 - The Average Data Rate, Average Data Rate per Stream, and Average Response Time reported at five second intervals.
4. Average Data Rate by Intervals, Average Data Rate per Stream by Intervals, and Average Response Time by Intervals graphs for the "64 KiB Transfer Size, 1 Outstanding I/O" Test Runs as specified in Clauses 10.1.4 – 10.1.6.

A hyperlink for each of the above tables and graphs may appear in the FDR to provide access to the table or graph.

A hyperlink to a table with the SPC-2 "Large Database Query/64 KiB TRANSFER SIZE/4 Outstanding I/Os" Test Run data appears on the next page. That entry is followed by hyperlinks to graphs illustrating the average Data Rate, average Data Rate per Stream, and average Response Time produced by the same Test Runs. The table and graphs present the data at five-second intervals.

Immediately following the above SPC-2 "Large Database Query/64 KiB TRANSFER SIZE/4 Outstanding I/Os" entries will be hyperlinks for SPC-2 "Large Database Query/64 KiB TRANSFER SIZE/1 Outstanding I/O" table and graphs. The table contains the Test Run data and the graphs illustrate the average Data Rate, average Data Rate per Stream, and average Response Time produced by the Test Runs.

SPC-2 “Large Database Query/64 KiB TRANSFER SIZE/4 Outstanding I/Os” Test Run Data

[SPC-2 “Large Database Query/64 KiB TRANSFER SIZE/4 Outstanding I/Os” Test Run Data Tables: Ramp-Up, Measurement Interval, Run-Out, and Ramp-Down Periods](#)

(3 pages)

SPC-2 “Large Database Query/64 KiB TRANSFER SIZE/4 Outstanding I/Os” Graphs

Average Data Rate – Complete Test Run

Average Data Rate – Measurement Interval (MI) Only

Average Data Rate per Stream

Average Response Time

[SPC-2 “Large Database Query/64 KiB TRANSFER SIZE/4 Outstanding I/Os” graphs](#)

(four pages, 1 graph per page)

SPC-2 “Large Database Query/64 KiB TRANSFER SIZE/1 Outstanding I/O” Test Run Data

[SPC-2 “Large Database Query/64 KiB TRANSFER SIZE/1 Outstanding I/O” Test Run Data Tables: Ramp-Up, Measurement Interval, Run-Out, and Ramp-Down Periods](#)

(3 pages)

SPC-2 “Large Database Query/64 KiB TRANSFER SIZE/1 Outstanding I/O” Graphs

Average Data Rate – Complete Test Run

Average Data Rate – Measurement Interval (MI) Only

Average Data Rate per Stream

Average Response Time

[SPC-2 “Large Database Query/64 KiB TRANSFER SIZE/1 Outstanding I/O” graphs](#)

(four pages, 1 graph per page)

Video on Demand Delivery Test

Clause 6.4.5.1

The Video on Demand Delivery Test represents the I/O operations required to enable individualized video entertainment for a community of subscribers, which draw from a digital film library.

Clause 6.4.5.2

The Video on Demand Delivery Test consists of one (1) Test Run.

The BC shall not be restarted or manually disturbed, altered, or adjusted during the execution of the Video on Demand Delivery Test. If power is lost to the BC during this Test all results shall be rendered invalid and the Test re-run in its entirety.

Clause 10.6.9.3

The Full Disclosure Report will contain the following content for the Video on Demand Delivery Test:

- 1. A listing of the SPC-2 Workload Generator commands and parameters used to execute the Test Run in the Video on Demand Delivery Test.*
- 2. The human readable SPC-2 Test Results File for the Test Run in the Video on Demand Delivery Test.*
- 3. A table that contains the following information for the Test Run in the Video on Demand Delivery Test:*
 - The number Streams specified.*
 - The Ramp-Up duration in seconds.*
 - The Measurement Interval duration in seconds.*
 - The average data rate, in MB per second, for the Measurement Interval.*
 - The average data rate, in MB per second, per Stream for the Measurement Interval.*
- 4. A table that contains the following information for the single Video on Demand Delivery Test Run:*
 - The number Streams specified.*
 - The average data rate, average data rate per stream, average Response Time, and Maximum Response Time reported at 60 second intervals.*
- 5. Average Data Rate by Intervals, Average Data Rate per Stream by Intervals, and Average Response Time by Intervals graphs for the single Video on Demand Delivery Test Run as specified in Clause 10.1.8.*
- 6. A Maximum Response Time (intervals) graph as specified in Clause 10.1.8.*

SPC-2 Workload Generator Commands and Parameters

The SPC-2 Workload Generator commands and parameters for the Video on Demand Delivery Test Run are documented in [Appendix E: SPC-2 Workload Generator Execution Commands and Parameters](#) on Page 74..

SPC-2 Test Results File

A link to the SPC-2 Test Results file generated from the Video on Demand Delivery Test Run is listed below.

[SPC-2 Video on Demand Delivery Test Results File](#)

SPC-2 Video on Demand Delivery Test Run Data

The number of Streams specified, Ramp-Up duration in seconds, Measurement Interval duration in seconds, average Data Rate for the Measurement Interval, and average Data Rate per Stream for the Measurement Interval are listed in the following table.

SPC-2-VOD	TR1
Number of Streams	14,000
Ramp-up Time, sec	1,200
Measurement Interval, sec	7,200
Average Data Rate, MB/sec	11,010.03
Per Stream Data Rate, MB/sec	0.79
Average Response Time, ms	1.74
Average Max Response Time, ms	5.97

Video on Demand Delivery Test – TEST RUN DATA BY INTERVAL

The SPC-2 Video on Demand Delivery Test Run data is contained in the table that appears below. That table is followed by graphs illustrating the average Data Rate and average Data Rate per Stream produced by the same Test Runs. The table and graphs present the data at sixty second intervals.

14,000 Streams					14,000 Streams					14,000 Streams				
TR1	14,000 Streams				TR1	14,000 Streams				TR1	14,000 Streams			
Test Run Sequence Time	Data Rate, MB/sec	Data Rate /Stream, MB/sec	Response Time, ms	Maximum Response Time, ms	Test Run Sequence Time	Data Rate, MB/sec	Data Rate /Stream, MB/sec	Response Time, ms	Maximum Response Time, ms	Test Run Sequence Time	Data Rate, MB/sec	Data Rate /Stream, MB/sec	Response Time, ms	Maximum Response Time, ms
0:01:00	1,101.27	0.67	0.81	2.35	0:48:00	11,010.06	0.79	1.72	5.32	1:35:00	11,010.03	0.79	1.73	5.33
0:02:00	3,160.88	0.77	1.04	3.04	0:49:00	11,009.02	0.79	1.73	5.41	1:36:00	11,009.97	0.79	1.71	5.44
0:03:00	4,731.23	0.78	1.17	3.83	0:50:00	11,010.14	0.79	1.75	5.86	1:37:00	11,009.89	0.79	1.75	5.61
0:04:00	6,081.27	0.78	1.29	3.96	0:51:00	11,010.10	0.79	1.71	5.44	1:38:00	11,010.10	0.79	1.75	5.40
0:05:00	7,234.07	0.78	1.37	4.62	0:52:00	11,010.04	0.79	1.72	5.24	1:39:00	11,010.08	0.79	1.71	5.65
0:06:00	8,212.69	0.78	1.43	5.18	0:53:00	11,009.98	0.79	1.76	5.40	1:40:00	11,009.47	0.79	1.75	5.79
0:07:00	9,045.86	0.78	1.48	12.53	0:54:00	11,010.10	0.79	1.71	5.42	1:41:00	11,009.90	0.79	1.76	6.04
0:08:00	9,722.76	0.78	1.56	7.34	0:55:00	11,010.10	0.79	1.72	6.42	1:42:00	11,010.00	0.79	1.71	5.34
0:09:00	10,313.97	0.78	1.63	7.24	0:56:00	11,010.08	0.79	1.76	5.39	1:43:00	11,010.03	0.79	1.74	5.43
0:10:00	10,819.24	0.78	1.68	8.40	0:57:00	11,010.16	0.79	1.72	5.49	1:44:00	11,009.93	0.79	1.77	5.71
0:11:00	11,010.17	0.79	1.76	9.14	0:58:00	11,010.03	0.79	1.71	5.22	1:45:00	11,010.04	0.79	1.73	5.74
0:12:00	11,010.03	0.79	1.77	9.25	0:59:00	11,010.02	0.79	1.76	5.66	1:46:00	11,010.08	0.79	1.74	5.59
0:13:00	11,010.13	0.79	1.72	9.26	1:00:00	11,009.96	0.79	1.73	5.33	1:47:00	11,011.10	0.79	1.78	5.62
0:14:00	11,010.09	0.79	1.74	9.28	1:01:00	11,009.94	0.79	1.71	5.17	1:48:00	11,010.18	0.79	1.74	5.61
0:15:00	11,010.07	0.79	1.77	9.50	1:02:00	11,010.18	0.79	1.75	5.62	1:49:00	11,010.01	0.79	1.74	5.52
0:16:00	11,009.98	0.79	1.72	9.15	1:03:00	11,011.09	0.79	1.75	5.54	1:50:00	11,010.12	0.79	1.79	5.65
0:17:00	11,010.00	0.79	1.74	9.03	1:04:00	11,009.94	0.79	1.71	5.39	1:51:00	11,010.16	0.79	1.75	6.36
0:18:00	11,010.17	0.79	1.77	8.92	1:05:00	11,010.16	0.79	1.74	5.61	1:52:00	11,009.95	0.79	1.73	5.20
0:19:00	11,011.10	0.79	1.73	8.86	1:06:00	11,010.17	0.79	1.76	5.69	1:53:00	11,010.00	0.79	1.78	5.59
0:20:00	11,009.94	0.79	1.73	9.73	1:07:00	11,010.23	0.79	1.72	5.21	1:54:00	11,010.09	0.79	1.76	5.57
0:21:00	11,010.17	0.79	1.75	5.55	1:08:00	11,009.80	0.79	1.74	5.33	1:55:00	11,010.05	0.79	1.73	5.65
0:22:00	11,010.09	0.79	1.72	5.15	1:09:00	11,010.13	0.79	1.76	5.42	1:56:00	11,010.03	0.79	1.77	6.08
0:23:00	11,010.08	0.79	1.71	5.22	1:10:00	11,010.15	0.79	1.71	5.13	1:57:00	11,010.09	0.79	1.77	5.43
0:24:00	11,010.03	0.79	1.75	5.56	1:11:00	11,009.67	0.79	1.72	5.05	1:58:00	11,010.05	0.79	1.73	5.33
0:25:00	11,010.00	0.79	1.74	5.97	1:12:00	11,010.17	0.79	1.76	5.50	1:59:00	11,010.06	0.79	1.76	5.54
0:26:00	11,010.90	0.79	1.72	5.42	1:13:00	11,009.90	0.79	1.72	5.26	2:00:00	11,010.00	0.79	1.78	5.66
0:27:00	11,009.12	0.79	1.75	5.57	1:14:00	11,010.14	0.79	1.72	5.02	2:01:00	11,010.01	0.79	1.73	5.59
0:28:00	11,010.08	0.79	1.75	5.54	1:15:00	11,010.11	0.79	1.77	5.30	2:02:00	11,011.18	0.79	1.73	5.75
0:29:00	11,010.02	0.79	1.72	5.27	1:16:00	11,010.11	0.79	1.74	5.36	2:03:00	11,010.07	0.79	1.76	5.68
0:30:00	11,010.15	0.79	1.75	5.76	1:17:00	11,009.82	0.79	1.72	5.12	2:04:00	11,010.11	0.79	1.72	5.43
0:31:00	11,010.06	0.79	1.77	5.69	1:18:00	11,010.89	0.79	1.76	5.65	2:05:00	11,010.11	0.79	1.71	5.36
0:32:00	11,010.04	0.79	1.73	5.37	1:19:00	11,010.18	0.79	1.75	5.43	2:06:00	11,010.04	0.79	1.75	6.06
0:33:00	11,010.05	0.79	1.74	5.71	1:20:00	11,010.13	0.79	1.72	5.14	2:07:00	11,009.99	0.79	1.72	5.56
0:34:00	11,011.15	0.79	1.78	5.71	1:21:00	11,010.20	0.79	1.75	5.44	2:08:00	11,009.96	0.79	1.71	5.36
0:35:00	11,010.05	0.79	1.73	5.44	1:22:00	11,010.20	0.79	1.75	5.41	2:09:00	11,010.10	0.79	1.76	6.07
0:36:00	11,010.04	0.79	1.74	5.62	1:23:00	11,010.02	0.79	1.71	5.14	2:10:00	11,009.39	0.79	1.74	10.73
0:37:00	11,010.20	0.79	1.78	6.53	1:24:00	11,010.16	0.79	1.74	5.41	2:11:00	11,010.02	0.79	1.71	9.93
0:38:00	11,010.11	0.79	1.74	5.42	1:25:00	11,010.31	0.79	1.76	5.76	2:12:00	11,010.11	0.79	1.75	9.77
0:39:00	11,009.90	0.79	1.73	5.53	1:26:00	11,009.81	0.79	1.71	5.43	2:13:00	11,010.05	0.79	1.75	9.13
0:40:00	11,010.06	0.79	1.78	5.73	1:27:00	11,010.26	0.79	1.73	5.42	2:14:00	11,009.82	0.79	1.71	9.98
0:41:00	11,010.20	0.79	1.74	5.41	1:28:00	11,010.23	0.79	1.76	5.72	2:15:00	11,010.08	0.79	1.75	11.39
0:42:00	11,010.00	0.79	1.71	5.48	1:29:00	11,010.13	0.79	1.72	5.43	2:16:00	11,010.11	0.79	1.76	11.91
0:43:00	11,010.13	0.79	1.77	5.35	1:30:00	11,009.74	0.79	1.72	5.48	2:17:00	11,009.97	0.79	1.71	8.68
0:44:00	11,010.12	0.79	1.76	5.79	1:31:00	11,010.11	0.79	1.77	5.71	2:18:00	11,010.11	0.79	1.74	9.33
0:45:00	11,009.91	0.79	1.71	5.39	1:32:00	11,010.26	0.79	1.73	5.14	2:19:00	11,010.13	0.79	1.76	10.83
0:46:00	11,009.98	0.79	1.75	5.67	1:33:00	11,009.81	0.79	1.71	5.12	2:20:00	11,009.95	0.79	1.72	11.94
0:47:00	11,010.08	0.79	1.76	5.64	1:34:00	11,010.18	0.79	1.76	5.73	0:00:00	0.00	0.00	0.00	0.00

SPC-2 Video on Demand Delivery Average Data Rate Graph

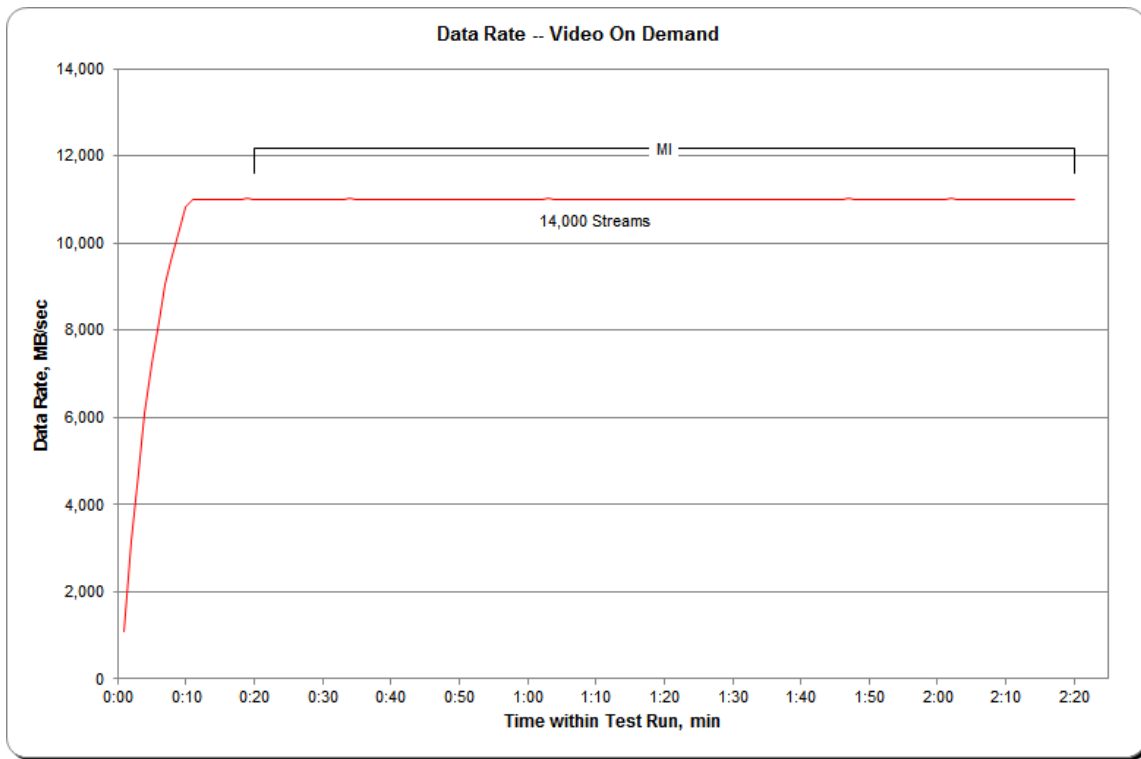

SPC-2 Video on Demand Delivery Average Data Rate per Stream Graph

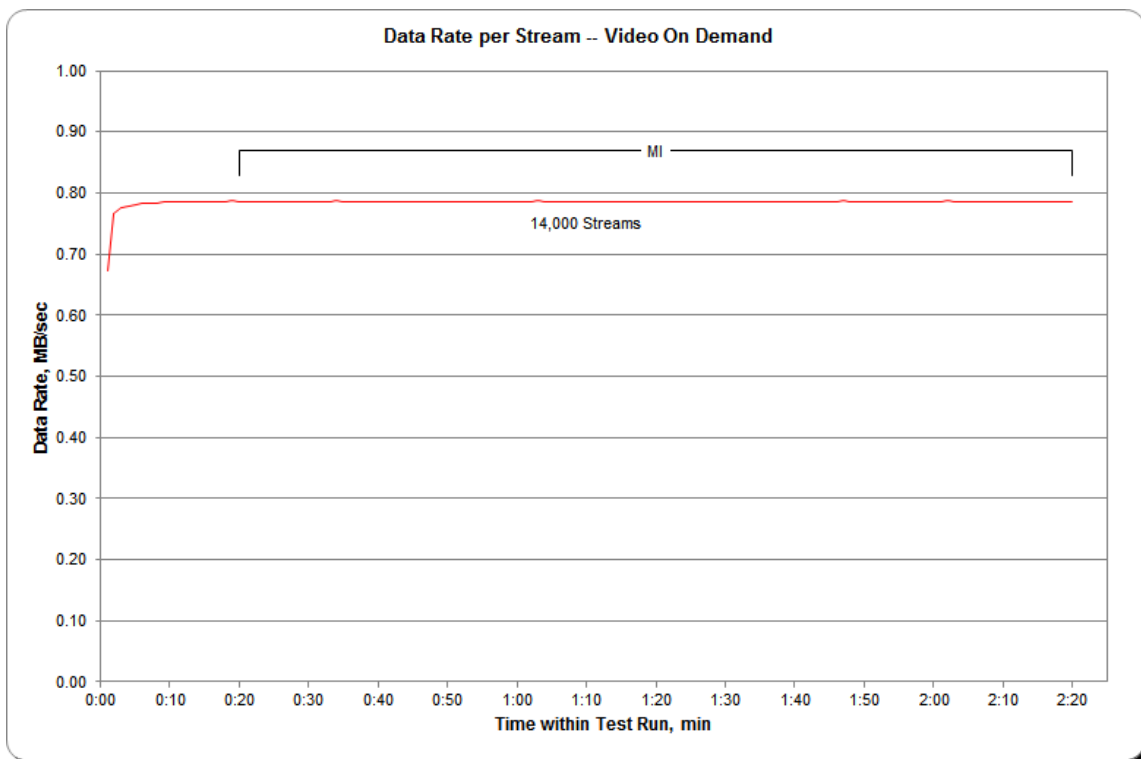

SPC-2 Video on Demand Delivery Average Response Time Graph

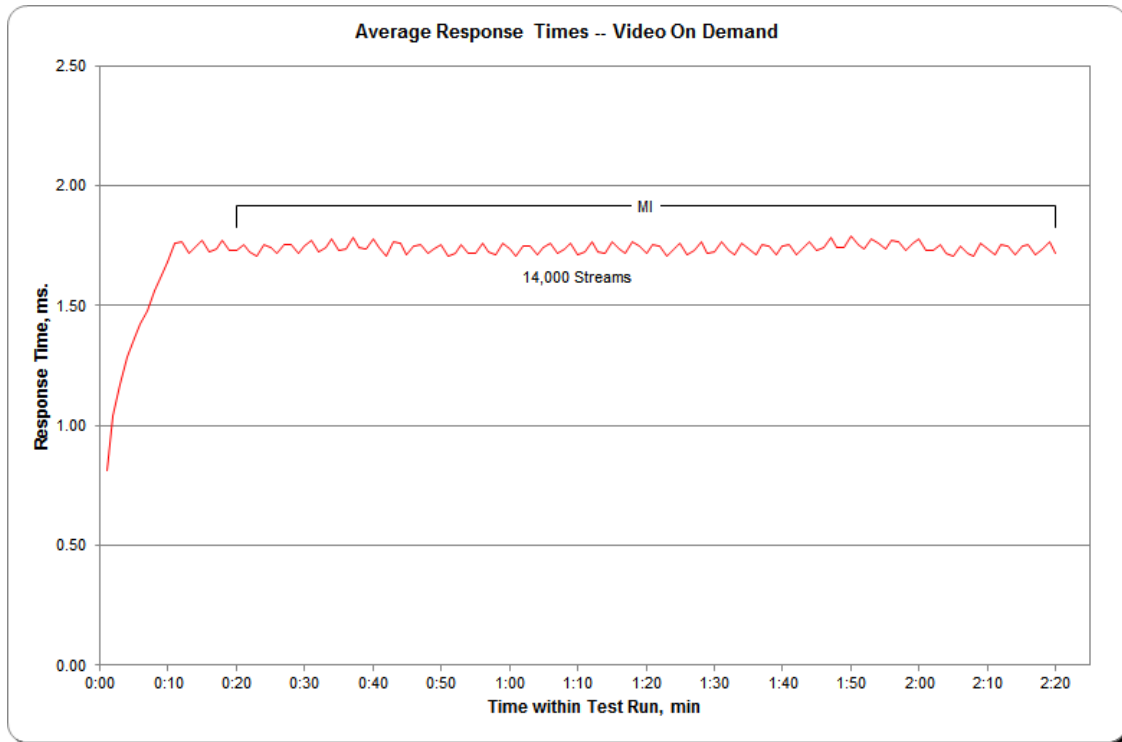

SPC-2 Video on Demand Delivery Maximum Response Time Graph

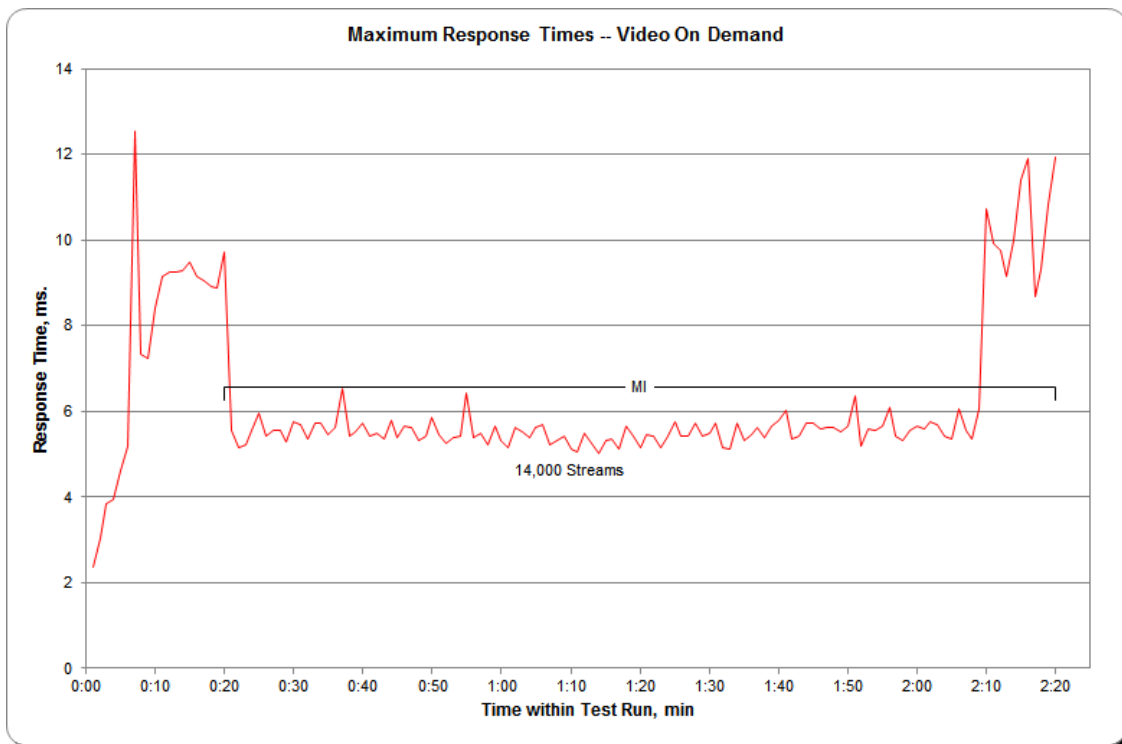

Data Persistence Test

Clause 7

The Data Persistence Test demonstrates the Tested Storage Configuration (TSC):

- *Is capable of maintain data integrity across a power cycle.*
- *Ensures the transfer of data between Logical Volumes and host systems occurs without corruption or loss.*

The SPC-2 Workload Generator will write a specific pattern at randomly selected locations throughout the Total ASU Capacity (Persistence Test Run 1). The SPC-2 Workload Generator will retain the information necessary to later validate the pattern written at each location.

The Tested Storage Configuration will be shutdown and restarted using a power off/power on cycle at the end of the above sequence of write operations. In addition, any caches employing battery backup must be flushed/emptied.

Restart the TSC, and if the Host System(s) were shutdown and powered off, restart the Host System(s).

The SPC-2 Workload Generator will utilize the retained data from Persistence Test Run 1 to verify (Persistence Run 2) the bit patterns written in Persistence Test Run 1 and their corresponding location.

Clause 10.6.9.4

The Full Disclosure Report will contain the following content for the Data Persistence Test:

1. *A listing of the SPC-2 Workload Generator commands and parameters used to execute each of the Test Runs in the Persistence Test.*
2. *The human readable SPC-2 Test Results File for each of the Test Runs in the Data Persistence Test.*
3. *A table from the successful Persistence Test, which contains the results from the test.*

SPC-2 Workload Generator Commands and Parameters

The SPC-2 Workload Generator commands and parameters for the Persistence Test Runs are documented in [Appendix E: SPC-2 Workload Generator Execution Commands and Parameters](#) on Page [74](#).

Data Persistence Test Results File

A link to the test result file generated from each Data Persistence Test Run is listed below.

[Persistence 1 Test Run \(write phase\) Results File](#)

[Persistence 2 Test Run \(read phase\) Results File](#)

Data Persistence Test Results

Data Persistence Test Results	
Data Persistence Test Number: 1	
Total Number of Logical Blocks Written	1,566,634
Total Number of Logical Blocks Re-referenced	97,071
Total Number of Logical Blocks Verified	1,469,563
Total Number of Logical Blocks that Failed Verification	0
Number of Failed I/O Requests in the process of the Test	0

PRICED STORAGE CONFIGURATION AVAILABILITY DATE

Clause 10.6.9

The committed delivery date for general availability (Availability Date) of all products that comprise the Priced Storage Configuration must be reported. When the Priced Storage Configuration includes products or components with different availability dates, the reported Availability Date must be the date at which all components are committed to be available. All availability dates, whether for individual components or for the Priced Storage Configuration as a whole, must be disclosed to a precision of one day.

The Availability Data shall be stated in either a combination of specific alphanumeric month, numeric day and numeric year or as “Currently Available”.

The NetApp EF560 All-Flash Array, as documented in this SPC-2 Full Disclosure Report, is currently available for customer purchase and shipment.

ANOMALIES OR IRREGULARITIES

Clause 10.6.12

The FDR shall include a clear and complete description of any anomalies or irregularities encountered in the course of executing the SPC-2 benchmark that may in any way call into question the accuracy, verifiability, or authenticity of information published in this FDR.

There were no anomalies or irregularities encountered during the SPC-2 Remote Audit of the NetApp EF560 All-Flash Array.

APPENDIX A: SPC-2 GLOSSARY

“Decimal” (*powers of ten*) Measurement Units

In the storage industry, the terms “kilo”, “mega”, “giga”, “tera”, “peta”, and “exa” are commonly used prefixes for computing performance and capacity. For the purposes of the SPC workload definitions, all of the following terms are defined in “powers of ten” measurement units.

- A kilobyte (KB) is equal to 1,000 (10^3) bytes.
- A megabyte (MB) is equal to 1,000,000 (10^6) bytes.
- A gigabyte (GB) is equal to 1,000,000,000 (10^9) bytes.
- A terabyte (TB) is equal to 1,000,000,000,000 (10^{12}) bytes.
- A petabyte (PB) is equal to 1,000,000,000,000,000 (10^{15}) bytes
- An exabyte (EB) is equal to 1,000,000,000,000,000,000 (10^{18}) bytes

“Binary” (*powers of two*) Measurement Units

The sizes reported by many operating system components use “powers of two” measurement units rather than “power of ten” units. The following standardized definitions and terms are also valid and may be used in this document.

- A kibibyte (KiB) is equal to 1,024 (2^{10}) bytes.
- A mebibyte (MiB) is equal to 1,048,576 (2^{20}) bytes.
- A gibibyte (GiB) is equal to 1,073,741,824 (2^{30}) bytes.
- A tebibyte (TiB) is equal to 1,099,511,627,776 (2^{40}) bytes.
- A pebibyte (PiB) is equal to 1,125,899,906,842,624 (2^{50}) bytes.
- An exbibyte (EiB) is equal to 1,152,921,504,606,846,967 (2^{60}) bytes.

SPC-2 Data Repository Definitions

Total ASU Capacity: The total storage capacity read and written in the course of executing the SPC-2 benchmark.

Application Storage Unit (ASU): The logical interface between the storage and SPC-2 Workload Generator. The ASU is implemented on one or more Logical Volume.

Logical Volume: The division of Addressable Storage Capacity into individually addressable logical units of storage used in the SPC-2 benchmark. Each Logical Volume is implemented as a single, contiguous address space.

Addressable Storage Capacity: The total storage (sum of Logical Volumes) that can be read and written by application programs such as the SPC-2 Workload Generator.

Configured Storage Capacity: This capacity includes the Addressable Storage Capacity and any other storage (parity disks, hot spares, etc.) necessary to implement the Addressable Storage Capacity.

Physical Storage Capacity: The formatted capacity of all storage devices physically present in the Tested Storage Configuration (TSC).

Data Protection Overhead: The storage capacity required to implement the selected level of data protection.

Required Storage: The amount of Configured Storage Capacity required to implement the Addressable Storage Configuration, excluding the storage required for the ASU.

Global Storage Overhead: The amount of Physical Storage Capacity that is required for storage subsystem use and unavailable for use by application programs.

Total Unused Storage: The sum of unused storage capacity within the Physical Storage Capacity, Configured Storage Capacity, and Addressable Storage Capacity.

SPC-2 Data Protection Levels

Protected 1: The single point of failure of any *storage device* in the configuration will not result in permanent loss of access to or integrity of the SPC-2 Data Repository.

Protected 2: The single point of failure of any *component* in the configuration will not result in permanent loss of access to or integrity of the SPC-2 Data Repository.

SPC-2 Test Execution Definitions

Completed I/O Request: An I/O Request with a Start Time and a Completion Time (see [“I/O Completion Types”](#) illustrated below).

Completion Time: The time recorded by the Workload Generator when an I/O Request is completed by the Tested Storage Configuration (TSC) as signaled by System Software.

Data Rate: The data volume, in MB, transferred by all Measured I/O Requests in an SPC-2 Test Run divided by the length of the Test Run in seconds.

Failed I/O Request: Any I/O Request issued by the SPC-2 Workload Generator that meets one of the following conditions (see [“I/O Completion Types”](#) illustrated below):

- The I/O Request was signaled as failed by System Software.
- The I/O Request started within the Measurement Interval, but did not complete prior to the end of the appropriate Run-Out period..
- The I/O Request started within the Run-Out period, but did not complete prior to the end of the appropriate Ramp-Down period.

I/O Request Throughput: The total number of Measured I/O Requests in an SPC-2 Test Run divided by the duration of the Measurement Interval in seconds.

Measured I/O Request: A Completed I/O Request that begins (Start Time) within a Measurement Interval and completes (Completion Time) prior to the end of the appropriate Ramp Down (see [“I/O Completion Types”](#) illustrated below).

Measurement Interval: A specified, contiguous period of time, after the TSC has reached Steady State, when data is collected by the Workload Generator to produce the test results for a SPC-2 Test Run (see [“SPC-2 Test Run Components”](#) illustrated below, *Test Run 1: T_2-T_3 and Test Run 2: T_7-T_8*).

Outstanding I/O Requests: The Outstanding I/O Requests parameter specifies the maximum number of concurrent I/O Requests, associated with a give Stream, which have been issued but not yet completed. (*Clause 3.4.4 of the SPC-2 Benchmark Specification*).

Ramp-Down: A specified, contiguous period of time in which the TSC is required to complete I/O Requests started but not completed during the preceding Run-Out period. Ramp-Down begins at the end of the preceding Run-Out period (see [“SPC-2 Test Run Components”](#) illustrated below, *Test Run 1: T_4-T_5 and Test Run 2: T_9-T_{10}*). The Workload Generator will not submit any I/O Requests during the Ramp-Down.

Ramp-Up: A specified, contiguous period of time required for the Benchmark Configuration (BC) to produce Steady State throughput after the Workload Generator begins submitting I/O Requests to the TSC for execution. The Ramp-Up period ends at the beginning of the Measurement Interval (see [“SPC-2 Test Run Components”](#) illustrated below, *Test Run 1: T_0-T_2 and Test Run 2: T_5-T_7*).

Response Time: The Response Time of a Measured I/O Request is its Completion Time minus its Start Time.

Run-Out: A specified, contiguous period of time in which the TSC is required to complete I/O Requests started but not completed during the preceding Measurement Interval. The Run-Out period begins at the end of the preceding Measurement Interval and is a component of the Steady State period (see [“SPC-2 Test Run Components”](#) illustrated below, *Test Run 1: T_3-T_4 and Test Run 2: T_9-T_{10}*). The Workload Generator will continue to submit I/O Requests at the Test Run’s specified rate during the Run-Out period.

Start Time: The time recorded by the Workload Generator when an I/O Request is submitted, by the Workload Generator, to the System Software for execution on the TSC.

Steady State: The period during which the workload presented to the TSC by the SPC-2 Workload Generator is constant and the resulting TSC I/O Request Throughput is both consistent and sustainable. The Steady State period includes both the Measurement Interval and Run-Out periods (see [“SPC-2 Test Run Components”](#) illustrated below, *Test Run 1: T_1-T_4 and Test Run 2: T_6-T_9*).

Steady State is achieved only after caches in the TSC have filled and as a result the I/O Request Throughput of the TSC has stabilized.

Stream: A collection of Stream Segments that started within a Test Run.

Stream Segment: A sequentially organized pattern of I/O requests, which transfers a contiguous range of data.

Test: A collection of Test Phases and or Test Runs sharing a common objective.

Test Phase: A collection of one or more SPC-2 Test Runs sharing a common objective and intended to be run in a specific sequence.

Test Run: The execution of SPC-2 that produces specific SPC-2 test results. SPC-2 Test Runs have specified, measured Ramp-Up, Measurement Interval, Run-Out and Ramp-Down periods. "[SPC-2 Test Run Components](#)" (*see below*) illustrates the Ramp-Up, Steady State, Measurement Interval, Run-Out, and Ramp-Down components contained in two uninterrupted SPC-2 Test Runs (*Test Run 1: T_0-T_5 and Test Run 2: T_5-T_{10}*).

Test Run Sequence: A related sequence of Large File Processing (LFP) or Large Database Query (LDQ) Test Runs. Each Test Run Sequence will consist of five Test Runs, which vary the number of Streams as follows:

- Test Run 1: Maximum number of Streams, which is selected by the Test Sponsor
- Test Run 2: 50% of the maximum number of Streams used in Test Run 1.
- Test Run 3: 25% of the maximum number of Streams used in Test Run 1.
- Test Run 4: 12.5% of the maximum number of Streams used in Test Run 1.
- Test Run 5: 1 Stream.

Each of the five Test Runs in a Test Run Sequence will share the same attributes with the exception of the number of Streams. For example:

- Large File Processing, Read, 1024 KiB Transfer Size: Maximum Streams
- Large File Processing, Read, 1024 KiB Transfer Size: 50% of Maximum Streams
- Large File Processing, Read, 1024 KiB Transfer Size: 25% of Maximum Streams
- Large File Processing, Read, 1024 KiB Transfer Size: 12.5% of Maximum Streams
- Large File Processing, Read, 1024 KiB Transfer Size: 1 Stream

Transfer Size: The Transfer Size parameter specifies the number of bytes in KiB to transfer. (*Clause 3.4.7 of the SPC-2 Benchmark Specification*)

I/O Completion Types

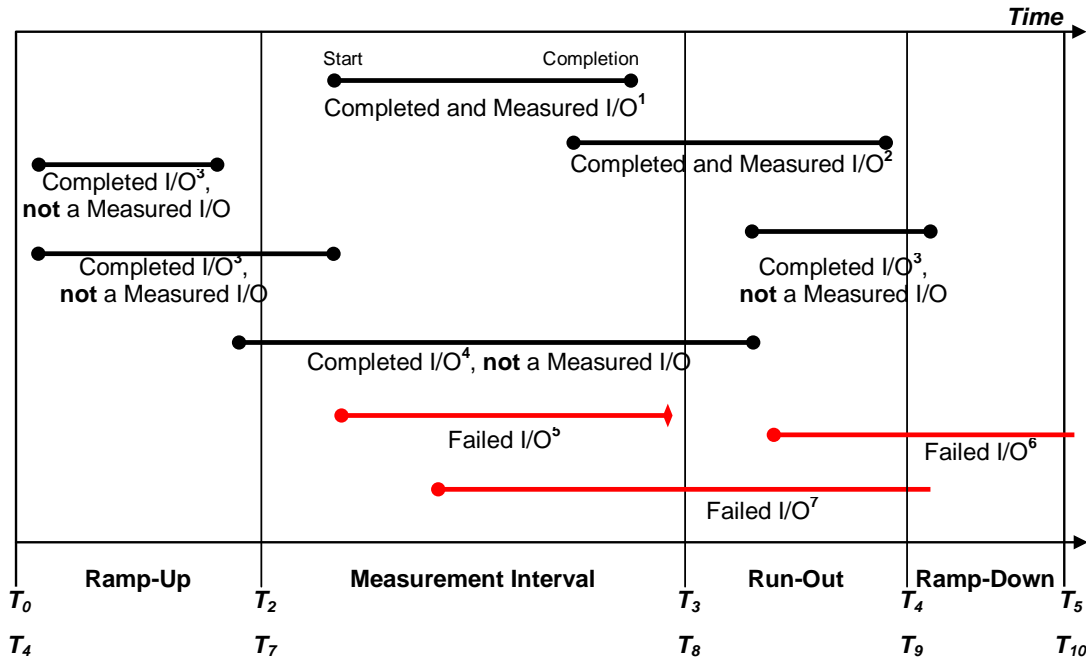

Completed and Measured I/O¹: I/O started and completed within the Measurement Interval.
Completed and Measured I/O²: I/O started within the Measurement Interval and completed within Ramp Down.
Completed I/O³: I/O started before or after the Measurement Interval – not measured.
Completed I/O⁴: I/O started before and completed after the Measurement Interval – not measured.
Failed I/O⁵: Signaled as failed by System Software.
Failed I/O⁶: I/O did not complete prior to the end of Ramp-Down.
Failed I/O⁷: I/O did not complete prior to the end of Run-Out.

SPC-2 Test Run Components

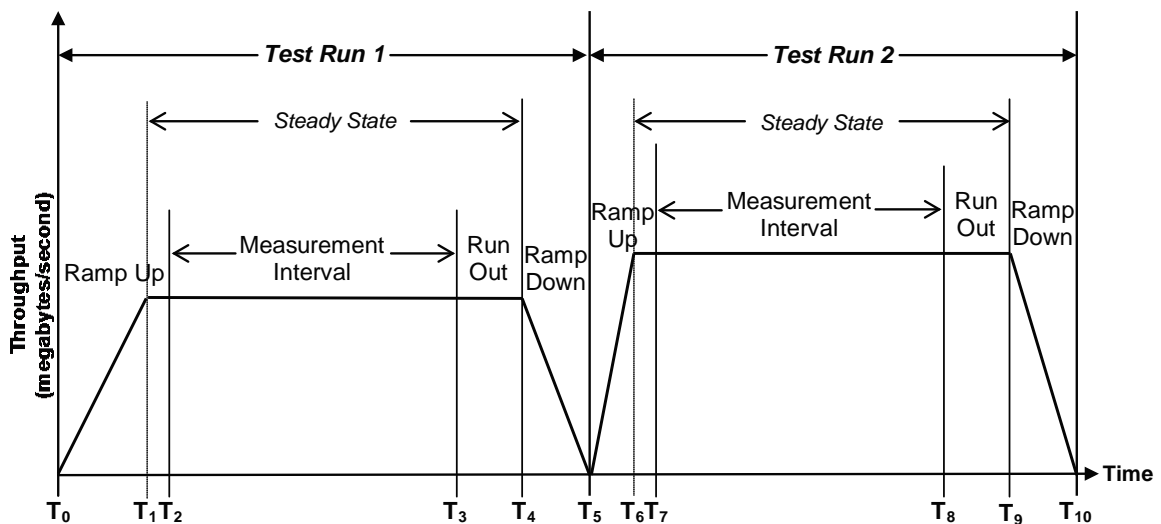

APPENDIX B: CUSTOMER TUNABLE PARAMETERS AND OPTIONS

HBA Parameters

The following QLogic Fibre Channel HBA parameters/options were changed from their default values using the [QConvergeConsole CLI](#) utility:

	Default Value	New Value
Operation Mode	<i>Interrupt when Interrupt Delay Timer expires or no active IO</i>	<i>Interrupt for every IO Completion</i>
LUNs Per Target	8	128
Port Down Retry Count	30	70

Operation Mode: Disable HBA interrupt coalescing.

LUNs Per Target: Specifies the number of LUNs per target.

Port Down Retry Count: Specifies the number of times the driver retries a command to a port returning port down status.

Windows Registry Settings

Set the maximum queue depth in the QLogic driver from a default value of 254 to 32 using the following Windows registry setting:

```
HKEY_LOCAL_MACHINE\SYSTEM\CurrentControlSet\services\ql2300\  
Parameters\Device\DriverParameter\qd=254
```

HBA Transfer Size

The HBA transfer size was changed to support 1 MB from a default of 512 as follows:

- **On each Host System,** open a DOS prompt window in administrator mode by entering **CMD** in the **Run/Search** line and pressing the **CTRL+SHIFT+ENTER** keys or right click on the **CMD** desktop icon and select **Run as Administrator**.
- Enter the following command line: **C:\>qlfc -tsize /fc /set 2048**
- Reboot the Host System for the change to take effect.

Storage Array Parameters

The [SPC2 RAID Config.script](#) script, documented in “[Appendix C: Tested Storage Configuration \(TSC\) Creation](#)”, changed the following storage array parameter from its default value as.

	Default Value	New Value
<i>cacheBlockSize</i>	8	32

CacheBlockSize: disk array controller cache allocation unit size in KiB (*1,024 bytes*).

APPENDIX C: TESTED STORAGE CONFIGURATION (TSC) CREATION

QLogic HBA Parameters

The QLogic HBA parameters/options, documented in [Appendix B, HBA Parameters](#), are changed prior to creating volumes on the storage array.

HBA Transfer Size Setting

The change in value of the HBA transfer size setting, documented in [Appendix B, HBA Transfer Size](#), may be changed prior to or after creating volumes on the storage array.

Windows Registry Setting

The Windows registry setting, documented in [Appendix B, Windows Registry Settings](#), may be changed prior to or after creating volumes on the storage array.

Storage Array Volume Creation

The storage management utility software, **E-Series SANtricity Storage Manager**, is installed on both Host Systems. It is a required software package that provides configuration, monitoring, and failover path management. The software is installed as a Windows installable package.

After installation, it can be found in `\Program Files\StorageManager\client` and is typically started with **Start→All Programs→SANtricity Storage Manager →SANtricity Storage Manager client**.

The **E-Series SANtricity Storage Manager** was used to create 2 volume groups on the storage subsystem. Each volume group contains two RAID6 volumes. All four RAID6 volumes are visible by each Host System.

The physical storage volumes are created on the storage array using the **E-Series SANtricity Storage Manager** script editor as follows:

- Launch **E-Series SANtricity Storage Manager**.
- From the Enterprise Management window, right-click the name of the storage array that you will be creating volumes on and select **Execute Script** from the pop-up menu.
- In the Script Editor window, load the [SPC2 RAID Config.script](#) script (*listed at the end of this appendix*).
- Once the script is loaded, select **Execute** from the Tools menu.

SPC-2 Logical Volume Creation

The steps that follow are executed on each Host System to discover the storage array volumes:

1. Reboot each Host System.
2. Start the Windows Disk Administrator, which will automatically discover the four RAID6 volumes.
3. Exit the Disk Administrator.

SPC2_RAID_Config.script

```
/* SPC-2 RAID Configuration Script */

create volume drives[ 0,1 0,2 1,1 1,2 0,3 0,4 1,3 1,4 0,9 1,10 ]
RAIDLevel=6
segmentSize=256
userLabel="LUN_0"
volumeGroupUserLabel="VG_1"
capacity=3177034285056
owner = A;

create volume volumeGroup["VG_1"] RAIDLevel=6 segmentSize=256 userLabel="LUN_1"
capacity=3177034285056 owner = b;

create volume drives[ 0,5 0,6 1,5 1,6 0,7 0,8 1,7 1,8 1,9 0,10 ]
RAIDLevel=6
segmentSize=256
userLabel="LUN_2"
volumeGroupUserLabel="VG_2"
capacity=3177034285056
owner = b;

create volume volumeGroup["VG_2"] RAIDLevel=6 segmentSize=256 userLabel="LUN_3"
capacity=3177034285056 owner = A;

/* define host mappings */
set volume["LUN_0"] logicalUnitNumber=0 hostGroup=defaultGroup;
set volume["LUN_1"] logicalUnitNumber=1 hostGroup=defaultGroup;
set volume["LUN_2"] logicalUnitNumber=2 hostGroup=defaultGroup;
set volume["LUN_3"] logicalUnitNumber=3 hostGroup=defaultGroup;

set allVolumes mirrorEnabled = True writeCacheEnabled = True
cacheWithoutBatteryEnabled = False cacheReadPrefetch = True;

set storageArray cacheBlockSize = 32;
set storageArray cacheFlushStart = 80;
```

APPENDIX D: SPC-2 WORKLOAD GENERATOR STORAGE COMMANDS AND PARAMETER FILES

ASU Pre-Fill

```
* SPC-2 Pre-Fill
* 1M sequential writes

compratio=1.0

sd=sd1,lun=\\.\PhysicalDrive1,threads=8
sd=sd2,lun=\\.\PhysicalDrive2,threads=8
sd=sd3,lun=\\.\PhysicalDrive3,threads=8
sd=sd4,lun=\\.\PhysicalDrive4,threads=8

wd=wd1,sd=sd*,xfersize=1048576,readpct=0,seekpct=-1

rd=rd1,wd=wd*,elapsed=36000,interval=10,iorate=max
```

Common Commands/Parameters – LFP, LDQ, VOD and Persistence Tests

The following command/parameter lines appear in each of the command and parameter files for the Large File Processing (LFP), Large Database Query (LDQ) and Video on Demand (VOD) Tests. The command lines are only listed below to eliminate redundancy.

```
sd=default,size=3177034285056

*** From Host bmr730c ***
sd=sd1,host=localhost,lun=\\.\PhysicalDrive1
sd=sd2,host=localhost,lun=\\.\PhysicalDrive2
sd=sd3,host=localhost,lun=\\.\PhysicalDrive3
sd=sd4,host=localhost,lun=\\.\PhysicalDrive4

*** From Host bmr730d ***
sd=sd1,host=bmr730d,lun=\\.\PhysicalDrive1
sd=sd2,host=bmr730d,lun=\\.\PhysicalDrive2
sd=sd3,host=bmr730d,lun=\\.\PhysicalDrive3
sd=sd4,host=bmr730d,lun=\\.\PhysicalDrive4

reportinginterval=5
```

Large File Processing Test (LFP)

* Large File Processing Test (LFP)

```
host=localhost,jvms=1,maxstreams=100  
host=(bmr730d),jvms=1,maxstreams=100,shell=spc2
```

[common commands](#)

```
maxlatestart=0  
segmentlength=512m
```

```
rd=default,rampup=180,periods=90,measurement=180,runout=45,rampdown=15,buffers=1
```

* LFP, "write" Test Phase

```
rd=default,rdpct=0,xfersize=1024k  
rd=TR1_SPC-2-FP2.0,streams=96  
rd=TR2_SPC-2-FP2.0,streams=48  
rd=TR3_SPC-2-FP2.0,streams=24  
rd=TR4_SPC-2-FP2.0,streams=12  
rd=TR5_SPC-2-FP2.0,streams=1
```

```
rd=default,xfersize=256k  
rd=TR6_SPC-2-FP2.0,streams=96  
rd=TR7_SPC-2-FP2.0,streams=48  
rd=TR8_SPC-2-FP2.0,streams=24  
rd=TR9_SPC-2-FP2.0,streams=12  
rd=TR10_SPC-2-FP2.0,streams=1
```

* LFP, "read-write" Test Phase

```
rd=default,rdpct=50,xfersize=1024k  
rd=TR11_SPC-2-FP2.0,streams=96  
rd=TR12_SPC-2-FP2.0,streams=48  
rd=TR13_SPC-2-FP2.0,streams=24  
rd=TR14_SPC-2-FP2.0,streams=12  
rd=TR15_SPC-2-FP2.0,streams=1
```

```
rd=default,xfersize=256k  
rd=TR16_SPC-2-FP2.0,streams=96  
rd=TR17_SPC-2-FP2.0,streams=48  
rd=TR18_SPC-2-FP2.0,streams=24  
rd=TR19_SPC-2-FP2.0,streams=12  
rd=TR20_SPC-2-FP2.0,streams=1
```

* LFP, "read" Test Phase

```
rd=default,rdpct=100,xfersize=1024k  
rd=TR21_SPC-2-FP2.0,streams=96  
rd=TR22_SPC-2-FP2.0,streams=48  
rd=TR23_SPC-2-FP2.0,streams=24  
rd=TR24_SPC-2-FP2.0,streams=12  
rd=TR25_SPC-2-FP2.0,streams=1
```

```
rd=default,xfersize=256k  
rd=TR26_SPC-2-FP2.0,streams=96  
rd=TR27_SPC-2-FP2.0,streams=48  
rd=TR28_SPC-2-FP2.0,streams=24  
rd=TR29_SPC-2-FP2.0,streams=12  
rd=TR30_SPC-2-FP2.0,streams=1
```

Large Database Query Test (LDQ)

* Large Data Query Test (LDQ)

```
host=localhost,jvms=1,maxstreams=100  
host=(bmr730d),jvms=1,maxstreams=100,shell=spc2
```

common commands

```
maxlatestart=0  
segmentlength=512m
```

```
rd=default,rdpct=99,rampup=180,periods=90,measurement=180,runout=45,rampdown=15
```

* LDQ, 1024 KiB Test Phase

```
rd=default,xfersize=1024k,buffers=4  
rd=TR1_SPC-2-DQ2.0,streams=96  
rd=TR2_SPC-2-DQ2.0,streams=48  
rd=TR3_SPC-2-DQ2.0,streams=24  
rd=TR4_SPC-2-DQ2.0,streams=12  
rd=TR5_SPC-2-DQ2.0,streams=1
```

```
rd=default,buffers=1  
rd=TR6_SPC-2-DQ2.0,streams=96  
rd=TR7_SPC-2-DQ2.0,streams=48  
rd=TR8_SPC-2-DQ2.0,streams=24  
rd=TR9_SPC-2-DQ2.0,streams=12  
rd=TR10_SPC-2-DQ2.0,streams=1
```

* LDQ, 64 KiB Test Phase

```
rd=default,xfersize=64k,buffers=4  
rd=TR11_SPC-2-DQ2.0,streams=96  
rd=TR12_SPC-2-DQ2.0,streams=48  
rd=TR13_SPC-2-DQ2.0,streams=24  
rd=TR14_SPC-2-DQ2.0,streams=12  
rd=TR15_SPC-2-DQ2.0,streams=1
```

```
rd=default,buffers=1  
rd=TR16_SPC-2-DQ2.0,streams=96  
rd=TR17_SPC-2-DQ2.0,streams=48  
rd=TR18_SPC-2-DQ2.0,streams=24  
rd=TR19_SPC-2-DQ2.0,streams=12  
rd=TR20_SPC-2-DQ2.0,streams=1
```

Video on Demand Delivery (VOD)

* Video on Demand Test (VOD)

```
host=localhost,jvms=7,maxstreams=1000  
host=(bmr730d),jvms=7,maxstreams=1000,shell=spc2
```

[common commands](#)

```
maxlatestart=0  
videosegmentduration=1200  
maxlatevod=0
```

* Official RD

```
rd=default,rampup=1200,periods=600,measurement=7200,runout=45,rampdown=15
```

```
rd=TR1_SPC-2-VOD11.0,streams=14000,buffers=8
```

SPC-2 Persistence Test Run 1 (write phase)

* Persistence Write Phase

```
host=localhost,jvms=1,maxstreams=100  
host=(bmr730d),jvms=1,maxstreams=100,shell=spc2
```

[common commands](#)

```
maxlatestart=1  
segmentlength=512m
```

```
rd=default,rampup=180,periods=90,measurement=300,runout=0,rampdown=0,buffers=1
```

```
rd=default,rdpct=0,xfersize=1024k  
rd=TR1-96s_SPC-2-persist-w,streams=96
```

SPC-2 Persistence Test Run 2 (read phase)

* Persistence Read Phase

```
host=localhost,jvms=1,maxstreams=100  
host=(bmr730d),jvms=1,maxstreams=100,shell=spc2
```

[common commands](#)

```
maxlatestart=1  
segmentlength=512m
```

```
maxpersistenceerrors=10
```

```
rd=default,buffers=1,rdpct=100,xfersize=1024k  
rd=TR1-96s_SPC-2-persist-r
```

APPENDIX E: SPC-2 WORKLOAD GENERATOR EXECUTION COMMANDS AND PARAMETERS

ASU Pre-Fill, Large File Processing Test, Large Database Query Test, Video on Demand Delivery Test, and SPC-2 Persistence Test Run 1 (*write phase*)

The connection between the remote Host System and Master Host System was started manually, via the **RemoteStart** command, as the first step in the benchmark execution sequence.

The following script, [phase1.spc2.bat](#), was invoked to complete the following in an uninterrupted execution sequence:

- The required ASU pre-fill.
- Create the first set of required configuration and storage capacity listings for a remote audit.
- Initialize the SPC-2 Logical Volumes.
- Execute the following:
 - Large File Processing (LFP) Test
 - Large Database Query (LDQ) Test
 - Video on Demand (VOD) Test
 - Persistence Test Run 1 (*write phase*)

The connection between the remote Host System and Master Host System was started manually, via the **RemoteStart** command, after the required TSC power off/power on cycle.

The script, [phase1.spc2.bat](#), was then invoked to complete the following in an uninterrupted execution sequence:

- SPC-2 Persistence Test Run 2 (*read phase*)
- Create the second set of required configuration and storage capacity listings for a remote audit.

phase1.spc2.bat

```
@echo off

echo "ASU prefill started....."
pushd \bench\vdbench\vdbench50401
call vdbench -f \bench\vdbench\spc2\spc2_prefill.parm -o \bench\vdbench\spc2\PreFill
popd
echo "ASU prefill complete....."

rem Directory where this is executed from:
set dir=%~dp0

rem set current class path
set cp=%~dp0

echo "Capture a storage profile at the start of the run....."
pushd "\Program Files\StorageManager\client"
smcli 10.113.120.156 10.113.120.157 -c "set storageArray time; show storageArray
time; show storageArray profile; show storageArray time;" -o
\bench\vdbench\spc2\config_at_start.txt -quick
popd

java -Xmx1536m -Xms512m -Xss96k -cp %cp% vdbench -w SPC2 -f lfp.audit -o 031216.init
-init

java -Xmx1536m -Xms512m -Xss96k -cp %cp% vdbench -w SPC2 -f lfp.audit -o 031216.lfp6

java -Xmx1536m -Xms512m -Xss96k -cp %cp% vdbench -w SPC2 -f ldq.audit -o 031216.ldq6

java -Xmx1536m -Xms512m -Xss96k -cp %cp% vdbench -w SPC2 -f vod.audit -o 031216.vod6

java -Xmx1536m -Xms512m -Xss96k -cp %cp% vdbench -w SPC2 -f persist1.audit -o
031216.persist1

echo "Capture a storage profile at the end of phase1....."
pushd "\Program Files\StorageManager\client"
smcli 10.113.120.156 10.113.120.157 -c "show storageArray time; show storageArray
profile; show storageArray time;" -o \bench\vdbench\spc2\config_at_mid.txt -quick
popd
```

SPC-2 Persistence Test Run 2 (*read phase*)

phase2.spc2.bat

```
@echo off

rem Directory where this is executed from:
set dir=%~dp0

rem set current class path
set cp=%~dp0

java -Xmx1536m -Xms512m -Xss96k -cp %cp% vdbench -w SPC2 -f persist2.audit -o
031216.persist2

echo "Capture a storage profile at the end of the run...."
pushd "\Program Files\StorageManager\client"
smcli 10.113.120.156 10.113.120.157 -c "show storageArray time; show storageArray
profile; show storageArray time;" -o \bench\vdbench\spc2\config_at_end.txt -quick
popd
```

THIRD-PARTY QUOTATION

QLogic QLE2672-CK HBAs



Office Hours Mon-Fri 9:30 AM- 7:00 PM EST
750 Shames Dr. Westbury, NY 11590
800-778-7759 516-334-7700 Fax: 516-334-7727
Gov, Edu and Approved Businesses Fax PO to 516 334-7727



HOME ABOUT US LOGIN - POLICIES SUPPORT CONTACT US 1 item(s)

Order Information						
	Part Number	Description	Qty	Price	Total	
Delete	QLE2672-CK	QLOGIC - SANBLADE 16GB DUAL PORT PCIE FIBRE CHANNEL HOST BUS ADAPTER WITH STANDARD BRACKET CARD ONLY (QLE2672-CK). NEW RETAIL FACTORY SEALED. IN STOCK.	4	\$1,300.00	\$5,200.00	
					Merchandise Subtotal : \$5,200.00	

Shipping - Billing Info			
Ship To		Bill To <input checked="" type="checkbox"/> Copy Ship To	
Company Name:	NetApp	Bill To Company:	NetApp
Attention:	Mark Register	Attention:	Mark Register
Street Address:	3718 North Rock Road	Street Address:	3718 North Rock Road
Suite/Unit/Apt:		Suite/Unit/Apt:	
City:	Wichita	City:	Wichita
State:	KS	State:	KS
Zipcode:	67226	Zipcode:	67226

Purchase Order:	
Contact Phone:	
Contact Fax:	
Your Email:	
Create Password :	
Confirm Password :	

* Must be Alphanumeric and minimum 7 characters

Tax Exempt | Blind Drop Ship

Payment Options			
<input checked="" type="radio"/> Credit / Debit Card		<input type="radio"/> PayPal <input type="radio"/> 1% Discount	
Card Type:	Select Credit Card Type	Name on Card:	
Card Expires on:	Month Year	Card Number:	
		Security Code:	

Save this card for future orders

Shipping Options

USA 48 States APO FPO AK HI PR

Free Ground \$0.00 + NoTax \$0.00 = \$5,200.00 Total

**Comments - NY Tax Exempt EIN Fax Certificate to 516 334-7727
Edu Gov and Lrg Business Fax PO to 516 334-7727**

Additional Comments Section

I have read and agree to Server Supply's [Terms and Conditions](#)

Copyright © 2004-2016 ServerSupply.com Inc.
All rights reserved. Review our [terms and conditions](#).
All Product names throughout this site are trademarks of their respective holders.

Fibre Channel Cables

CDW CART FOR REVIEW



Account Message:

This email was sent to you from: **VALUED CUSTOMER**

Sender Comments:

CART DETAILS				
ITEM	QTY	PART #	UNIT PRICE	EXT. PRICE
 Tripp Lite 2M 10Gb Duplex Multimode 50/125 OM3 Fiber Cable LC/LC Aqua 6' Part#: N820-02M UNSPSC: 26121609 Go to Site	8	1148024	\$22.99	\$183.92
Sub Total:				\$183.92
GRAND TOTAL:				\$183.92