



SPC BENCHMARK-2™ (SPC-2™)

EXTENSION (SPC-2/E™)

Official

Version 1.7 – Effective 18 September 2017

Storage Performance Council (SPC)

PO Box 3504

Redwood City, CA 94064-3504

Phone (650) 556-9384

www.storageperformance.org
spcadmin@storageperformance.org

Copyright © 2017 Storage Performance Council

SPC Membership

(as of March 2013)

ADATA Technology Co., Ltd.	Link_A_Media Devices Corporation
Austin Automation Center	LSI Corporation
– Department of Veteran Affairs	NEC Corporation
DataDirect Networks	NetApp, Inc.
Dell Compellent	Nimbus Data Systems, Inc.
Dot Hill Systems Corp.	Oracle Corporation
EMC Corporation	Pennsylvania State University
Foundation for Research and Technology	Samsung Information Systems, America
– Institute of Computer Science	SanDisk Corporation
Fujitsu Computer Systems Corporation	Seagate Technology LLC
The George Washington University	Silicon Graphics International
Hewlett-Packard Company	SolidFire, Inc.
Hitachi Data Systems	STEC, Inc.
Hongik University	Toshiba America Information Systems, Inc.
Huawei Technologies Co., Ltd.	University of California, Santa Cruz
IBM Corporation	Violin Memory, Inc.
Infortrend Technology, Inc.	Western Digital Corporation
Jabil Circuit, Inc.	X-IO Technologies
Kaminario, Inc.	
Korea Advanced Institute of Science and Technology	

DOCUMENT HISTORY

<u>Effective Date</u>	<u>Version</u>	<u>Description</u>
6 December 2005	0.1.0	<i>Approved 12 October 2005</i> The first official release of the SPC Benchmark-2™ (SPC-2) specification. Approved unanimously by the SPC membership.
19 March 2006	1.1.0	<i>Approved 18 January 2006</i> Revised Clause 9.1.6 to remove the requirement for pricing maintenance for HBAs included in the Priced Storage Configuration. Revised Clause 10.6.9 to allow the use of “Currently Available” for the SPC-1 Availability Date in the case where all components that comprise the Priced Storage Configuration are currently available for customer order and shipment. Revised Clause 4.3 and add Clause 4.6 to introduce and define the term “Tested Storage Product”, which will become the focal point of SPC-1 results and the source of labeling for each result.

Added Clauses 4.6.1 and 4.6.2 to define two categories of SPC-1 results based on the absence or presence of all storage devices as a standard part of the Tested Storage Product.

Revised Clause 4.5.1 to be consistent with the introduction of a Tested Storage Product as the focal point for each SPC-1 result.

Revised Clause 8 to require statement of the appropriate TSP category when there is a public reference to a specific SPC-2 result.

<u>Effective Date</u>	<u>Version</u>	<u>Description</u>
19 March 2006	1.1.0	<i>Approved 18 January 2006</i> Revised Clause 10.6.1 to use the formal TSP name on the FDR title page rather than the TSC name. Revised Clause 10.6.5.3 and Table 108 to include an entry for the appropriate TSC category value.

<u>Effective Date</u>	<u>Version</u>	<u>Description</u>
25 September 2006	1.2.0	<i>Approved 27 July 2006</i> Revised Clause 6.3.6 to address pre-fill/pre-allocation requirement. Revised Clause 6.4.1 and added Clause 6.4.2 to establish the approved Test Run sequence requirement. Revised Clauses 10.1.1-10.1.3 to only reference the data table and graph for LFP and LDQ, specifying a data table/graph pair for each Test. Revised Table 10-1 – Table 10-3 and Figure 10-1 – Figure 10-3 (labeled bar charts). Revised Clauses 10.1.4-10.1.6 to move the reference to the VOD Test Run and renamed each clause for clarity. New Clauses 10.1.7-10.1.9 to define the required VOD FDR tables and graphs. New Table 10-6 - Table 10.7 to provide an example of the required VOD FDR tables. Added Figure 10-7 - Figure 10-10 in support of new Clauses 10.1.7-10.1.9. Revised Clauses 10.6.8.1 (LFP Test) and 10.6.8.2 (LDQ Test) to include the average Response Time table and graph FDR requirement. Revised Clauses 10.6.8.1 (LFP Test) and 10.6.8.2 (LDQ Test) for clarity and correct cross references. Revised Clauses 10.6.8.1-10.6.8.3 (LFP Test Phases) and Clauses 10.6.8.2.1-10.6.8.2.2 (LDQ Test Phases) for clarity and correct cross references. Revised Clause 10.6.8.3 (VOD Test) to support new Clauses 10.1.7-10.1.9. The new clauses define the required VOD FDR tables and graphs.

<u>Effective Date</u>	<u>Version</u>	<u>Description</u>
27 September 2006	1.2.1	<p>Approved 27 September 2006</p> <p>Revised Clauses 4.6.1 and 4.6.2 to clarify the SPC-1 Results categorization requirements.</p> <p>Deleted the requirement for a Data Rate per Stream graph in Clause 10.1.8.</p> <p>Added Clause 10.6.5.3 to require a brief description of the Tested Storage Product in the Executive Summary.</p>
19 July 2009	1.3.0	<p>Approved 20 May 2009</p>
18 November 2012	1.4.0	<p>Approved 19 September 2012</p> <p>Clause 2.2: Revised to allow Physical Storage Capacity to be reported either as formatted capacity or capacity available for application use.</p> <p>Clause 2.7: Revised to define two levels of data protection: Protected 1 and Protected 2.</p> <p>Clause 4.5.1: System software pricing exclusions to match SPC-1.</p> <p>Clause 6.3.3: New wording to require the SPC-2 ASU to be completely filled with specified content prior to audited Test Run execution (ASU pre-fill).</p> <p>Clause 6.3.13: New wording to allow Adaptive Data Migration.</p> <p>Clause 8.3: New wording to define SPC-1 Associated Data.</p> <p>Clauses 8.4.1 and 8.6.1: New wording listing the requirements for public reference when using a nonlocal currency.</p> <p>Clauses 8.4.2: Revised to clarify requirements when referencing a single SPC-2 Result.</p> <p>Clauses 8.4.2.1, 8.4.4, 8.6.2 and 8.6.3: Revised to require “current as of” date.</p> <p>Clause 8.3.4: Revised to address comparisons of SPC-2 Price-Performance and SPC-2 Total Price with regards to pricing currency and the “target country”.</p> <p>Clause 8.4.4: Revised to clarify requirements when referencing a two or more SPC-2 Results.</p> <p>Clause 9.1.4.4: New wording to required appropriate racking/cabinetry and power distribution if the Priced Storage Configuration is greater than 20U.</p> <p>Clause 9.1.6: New wording to include the Host System(s) that are TSC components.</p> <p>Clause 9.1.6: Revised to require inclusion of applicable tariffs, duties, and import fees if not included listed product pricing and to exclude any shipping costs.</p> <p>Clause 9.1.6: Revised to exclude shipping cost.</p>

Clauses 9.2.1.4 and 9.2.1.5: Deleted requirement for local currency pricing.

Clause 9.2.2.2: Revised to reference the specified “target country”.

Clause 9.2.2.5: Deleted because of redundancy.

Clause 9.2.3: New wording to define the “target country” and requirements for pricing.

Clause 9.2.4: New wording to define local and nonlocal currency pricing and requirements.

Clause 9.3.1.4: Revised to require the total price to be stated in the minimum level of negotiable detail for the selected pricing currency.

Clause 9.3.2: Deleted because of redundancy.

Clause 10.6.5.1: Delete co-sponsor references.

Clause 10.6.5.2: Revised to require FDR revision details to be highlighted when appropriate.

Clause 10.6.5.4, Table 10-10: Revised to include the Currency Used and “Target Country”.

Clause 10.6.5.6: New wording requiring the Executive Summary to include the basis (type and justification) of discounts included in the pricing.

Clause 10.6.6: Revised to delete the “UID” and “WG” annotations.

Clause 10.6.8.1: Revised to require an annotation that addresses reserved system overhead storage capacity that might not be included in the reported Physical Storage Capacity.

Clause 12: New wording for the SPC-2/E Energy Extension

12 May 2013 1.5.0

Approved 13 March 2013

Clause 6.3.3.3: New wording to explicitly require the ASU pre-fill to be executed as the first step in the uninterrupted benchmark execution sequence.

Clause 6.3.13: Revised wording to expand the use of Adaptive Data Migration.

Clause 10.6.5.7: Revised wording to clarify how differences between the Tested Storage Configuration and Priced Storage Configuration are documented.

Clause 10.6.8.1: Revised wording to replace storage capacities illustration with four charts.

Clauses 10.6.9.1.1 – 10.6.9.1., 10.6.9.2.1 and 10.6.9.2.2: Revised wording to allow hyperlinks to the required tables and graphs rather than embed the tables and graphs in the FDR.

15 January 2017 1.6.0

Approved 15 November 2016

Clause: 9.3.1.7: Include a required disclaimer on the Pricing Spreadsheet

18 September 2017 1.7.0

Approved 23 May 2017

Clause: 4.3: Remove references to System Software and replace with wording focused on Host Systems, to align with SPC-1 changes.

Clause 4.5: Clarify Host System inclusion requirements

Table of Contents

CLAUSE 0 : INTRODUCTION	10
0.1 PREAMBLE	10
0.2 GENERAL GUIDELINES.....	11
0.3 MEASUREMENT GUIDELINES	12
0.4 DISCLAIMER.....	13
0.5 SPC BENCHMARK SERIES.....	13
CLAUSE 1 : WORKLOAD ENVIRONMENT.....	14
1.1 BUSINESS AND APPLICATION ENVIRONMENT	14
1.2 HIGH-LEVEL WORKLOAD MODEL	14
CLAUSE 2 : DATA REPOSITORY.....	15
2.1 SPC-2 STORAGE HIERARCHY.....	15
2.2 PHYSICAL STORAGE CAPACITY (PSC).....	15
2.3 CONFIGURED STORAGE CAPACITY (CSC)	16
2.4 ADDRESSABLE STORAGE CAPACITY (ASC)	16
2.5 LOGICAL VOLUMES (LV).....	17
2.6 APPLICATION STORAGE UNIT (ASU)	17
2.7 DATA PROTECTION.....	18
2.8 CAPACITY UTILIZATION	18
CLAUSE 3 : WORKLOAD AND I/O OPERATION PROFILE.....	20
3.1 DEFINITIONS.....	20
3.2 SPC-2 WORKLOAD COMPONENTS.....	21
3.3 SPC-2 PARAMETER TYPES	21
3.4 SPC-2 WORKLOAD PARAMETERS.....	24
3.5 TECHNICAL WORKLOAD DESCRIPTION	26
CLAUSE 4 : BENCHMARK CONFIGURATION AND TESTED STORAGE CONFIGURATION	28
4.1 DEFINITIONS.....	28
4.2 BENCHMARK CONFIGURATION COMPONENT AVAILABILITY AND SUPPORT.....	28
4.3 BENCHMARK CONFIGURATION COMPONENTS	28
4.4 BENCHMARK CONFIGURATION EXAMPLES	28
4.5 TESTED STORAGE CONFIGURATION COMPONENTS.....	31
4.6 TESTED STORAGE PRODUCT (TSP).....	35
CLAUSE 5 : SPC-2 WORKLOAD GENERATOR.....	36
5.1 OVERVIEW.....	36
5.2 MULTIPLE HOST SYSTEM CONFIGURATIONS	36
5.3 APPLICATION STORAGE UNIT (ASU) ACCESS	37
5.4 TRANSFER ADDRESS DETERMINATION	37
5.5 MEASUREMENT BOUNDARY	37
CLAUSE 6 : TEST MEASUREMENT REQUIREMENTS (EXECUTION RULES).....	39
6.1 SUPPORTING DEFINITIONS	39
6.2 STORAGE CAPACITIES	42
6.3 REQUIREMENTS AND CONSTRAINTS	43
6.4 SPC-2 TESTS	46
CLAUSE 7 : DATA PERSISTENCE REQUIREMENTS AND TEST	64
7.1 INTRODUCTION	64

7.2	PERSISTENCE TEST VALIDATION	64
7.3	SPC-2 PERSISTENCE TEST CONSTRAINTS	64
7.4	DATA PERSISTENCE TEST PROCEDURE.....	64
CLAUSE 8 : REPORTED METRICS		66
8.1	SPC-2 REPORTED DATA.....	66
8.2	SPC-2 PRICE-PERFORMANCE	66
8.3	SPC-2 ASSOCIATED DATA.....	66
8.4	SPC-2 PRIMARY METRICS – PUBLIC USE REQUIREMENTS.....	67
8.5	SPC-2 TEST-SPECIFIC REPORTED DATA	68
8.6	SPC-2 TEST-SPECIFIC REPORTED DATA – PUBLIC USE REQUIREMENTS.....	71
CLAUSE 9 : PRICING		73
9.1	PRICED COMPONENTS.....	73
9.2	PRICING METHODOLOGY	75
9.3	REQUIRED REPORTING	77
CLAUSE 10 : FULL DISCLOSURE REPORT (FDR).....		79
10.1	REQUIRED GRAPHS AND DATA TABLES	79
	89
10.2	FULL DISCLOSURE REPORT REQUIREMENTS	96
10.3	FULL DISCLOSURE REPORT AVAILABILITY	96
10.4	REVISIONS TO A PREVIOUSLY SUBMITTED FULL DISCLOSURE REPORT.....	96
10.5	COMPONENT SUBSTITUTION IN A REVISED FULL DISCLOSURE REPORT.....	97
10.6	FULL DISCLOSURE REPORT CONTENT	97
CLAUSE 11 : AUDIT AND RESULTS SUBMISSION		124
11.1	INTRODUCTION.....	124
11.2	SPC-2 RESULT VALIDATION	124
11.3	PEER REVIEW	124
11.4	AUDIT	124
11.5	REPUBLISHING AN SPC-2 BENCHMARK RESULT.....	126
11.6	AUDIT METHODS	126
11.7	AUDIT PROCEDURES.....	127
CLAUSE 12 : SPC-2/E ENERGY EXTENSION.....		131
12.1	OVERVIEW	131
12.2	APPARATUS	131
12.3	DISCLOSURE REQUIREMENTS	131
12.4	MEASUREMENTS	131
12.5	POWER PROFILES	133
12.6	NAMING CONVENTION	134
12.7	SPC-2/E REPORTED DATA	135
12.8	SPC-2/E FULL DISCLOSURE REPORT (FDR) REQUIREMENTS	142
12.9	SPC-2/E AUDIT REQUIREMENTS.....	142

Table of Figures

Figure 2-1: SPC-2 Storage Hierarchy	15
Figure 2-2: ASU-to-Logical Volume Address Mappings	18
Figure 4-1: Benchmark Configuration – Direct Attach Storage Controller	29
Figure 4-2: Benchmark Configuration – Network Storage.....	30
Figure 4-3: Embedded Storage Controller – External Storage Devices.....	32
Figure 4-4: Embedded Storage Controller – Embedded Storage Devices.....	33
Figure 4-5: Network Storage and External Storage Controller	34
Figure 5-1: Measurement Boundary.....	37
Figure 5-2: Measurement Boundary in an UNIX System Implementation	38
Figure 6-1: SPC-2 Test Run Components	41
Figure 6-2: I/O Completion Types.....	42
Figure 6-3: Summary of SPC-2 Tests	47
Figure 6-4: Summary of SPC-2 Tests (continued)	48
Figure 6-5: Large File Processing WRITE ONLY Test Phase.....	49
Figure 6-6: Large File Processing READ-WRITE Test Phase	52
Figure 6-7: Large File Processing READ ONLY Test Phase.....	54
Figure 6-8: Large Database Query 1024 KB TRANSFER SIZE Test Phase	56
Figure 6-9: Large Database Query 64 KiB TRANSFER SIZE Test Phase	59
Figure 6-10: Video On Demand Delivery Test.....	62
Figure 10-1: Average Data Rate Graph (<i>Large File Processing Test</i>).....	80
Figure 10-2: Average Data Rate per Stream Graph (<i>Large Database Query Test</i>)	83
Figure 10-3: Average Response Time (<i>Large File Processing Test</i>)	85
Figure 10-4: Average Data Rate by Interval Graph (<i>LFP</i>)	86
Figure 10-5: Average Data Rate per Stream by Interval Graph (<i>LFP</i>)	87
Figure 10-6: Average Data Rate per Stream by Interval Graph (<i>LFP</i>)	88
Figure 10-7: Average Data Rate by Intervals Graph (<i>VOD</i>).....	93
Figure 10-8: Average Response Time by Intervals Graph (<i>VOD</i>).....	94
Figure 10-9: Maximum Response Time by Intervals Graph (<i>VOD</i>).....	94
Figure 10-10: Benchmark Configuration/Tested Storage Configuration Diagram	105
Figure 10-11: Storage Network Configuration Diagram.....	107
Figure 10-12: SPC-2 Physical Storage Capacity	113
Figure 10-13: SPC-2 Configured Storage Capacity	114
Figure 10-14 SPC-2 Addressable Storage Capacity	115
Figure 10-15 SPC-2 Total Unused Storage Capacity Ratio and Detail	115
Figure 12-1: SPC/E Idle Test.....	136

Figure 12-2: SPC-2/E Large File Processing, WRITE ONLY Test Phase.....137
Figure 12-3: SPC-2/E Large Processing, READ-WRITE Test Phase.....138
Figure 12-4: SPC-2/E Large File Processing, READ ONLY Test Phase.....139

Table of Tables

Table 3-1: Large File Processing (LFP) Parameter Types and Values26
Table 3-2: Large Database Query (LDQ) Parameter Types and Values.....27
Table 3-3: Videos on Demand (VOD) Parameter Types and Values.....27
Table 6-1: Large File Processing (LFP) Required Stream Values.....50
Table 6-2: Large Database Query (LDQ) Required Stream Values.....57
Table 10-1: Average Data Rate Data Table (*Large File Processing Test*)79
Table 10-2: Average Data Rate per Stream Data Table (*Large Database Query Test*)82
Table 10-3: Average Response Time Table (*Large File Processing Test*).....84
Table 10-4: Average Date Rate, Average Data Rate per Stream, and Average Response Time by Interval Data Table (LFP) – Ramp-Up Period.....89
Table 10-5: Average Date Rate, Average Data Rate per Stream, and Average Response Time by Interval Data Table (LFP) – Measurement Interval, Run-Out, and Ramp-Down Periods.....90
Table 10-6: Average Data Rate, Data Rate per Stream, and Response Time Table (*VOD*) 91
Table 10-7: Average Data Rate, Data Rate per Stream, and Response Time Table (*VOD*) 92
Table 10-8: Test Sponsor and Contact Information.....98
Table 10-9: Revision Information and Key Dates.....99
Table 10-10: SPC-2 Reported Data100
Table 10-11: Priced Storage Configuration Components.....103
Table 10-12: Host System(s) and Tested Storage Configuration108
Table 10-13: SPC-2 Storage Capacities.....111
Table 10-14: SPC-2 Storage Hierarchy Ratios.....112
Table 10-15: SPC-2 Capacity Utilization.....116
Table 10-16: SPC-2 Capacity Utilization.....116
Table 10-17: Data Persistence Test Results122
Table 10-18: Original SPC-2 Information123
Table 12-1: Large File Processing, Large Database Query and Video on Demand Delivery Composite Power Profile140
Table 12-2: Large File Processing (LFP) Power Profile140
Table 12-3: Large Database Query (LDQ) Power Profile141
Table 12-4: Video on Demand Delivery (VOD) Power Profile141

Clause 0: Introduction

0.1 Preamble

The SPC Benchmark-2™ (SPC-2) is a series of related benchmark performance tests that simulate the sequential component of demands placed upon on-line, non-volatile storage in server class computer systems. SPC-2 provides measurements in support of real world environments characterized by:

- Large numbers of concurrent sequential transfers.
- Demanding data rate requirements, including requirements for real time processing.
- Diverse application techniques for sequential processing.
- Substantial storage capacity requirements.
- Data persistence requirements to ensure preservation of data without corruption or loss.

SPC-2 is designed as a source of comparative storage subsystem performance information. It is intended to provide value throughout the storage product lifecycle (e.g. development of product requirements; product implementation; performance tuning; capacity planning; market positioning; and purchase evaluations).

In view of the broad applicability of the SPC-2 benchmark, it is anticipated that readers may wish to approach the present document via a variety of starting points. For example:

- Readers who need only a quick overview of the benchmark itself can obtain one by examining Clause 1 (broad introduction to the benchmark structure) as well Table 3-1, Table 3-2, and Table 3-3 (the I/O workload characteristics presented in tabular form).
- Readers who wish a detailed understanding of the benchmark should, in addition, consult Clause 2: Data Repository, Clause 3: Workload and I/O Operation Profile, and Clause 4: Benchmark Configuration and Tested Storage Configuration.
- Readers who are examining or referring to test results obtained by running the SPC-2 benchmark should minimally examine Clause 8: Reported Metrics. Clause 6: Test Measurement Requirements (Execution Rules) is also recommended for such readers.
- Readers who wish to actually run an SPC-2 benchmark test should minimally examine Clause 2: Data Repository, Clause 6: Test Measurement Requirements (Execution Rules), and Clause 8: Reported Metrics.
- Finally, readers who wish to submit SPC-2 benchmark results for posting by the SPC must read the entire SPC-2 specification to ensure compliance with its provisions.

The SPC-2 specification is intended to be vendor and platform independent. Any vendor should be able to sponsor and publish an SPC-2 benchmark, provided their tested configuration satisfies the performance, integrity, and availability requirements of the specification. Further, the benchmark is intended to be meaningful across a broad range of system configurations and storage topologies including:

- *Different storage components*: the specification allows virtually any combination of storage technologies in a system configuration. Implementers are free to use any combination of storage types and to select the level of redundancy and reliability that best showcases their solution.
- *Various interconnect topologies*: the benchmark has been designed to allow for all forms of system and network interconnection. New network-based solutions (i.e., SANs) and more traditional host-based systems can both produce accurate and meaningful benchmark results.
- *Varied task assignments*: SPC-2 allows vendors to optimally demonstrate the performance features of their storage solutions. In addition and regardless of implementation choices, SPC-2 will provide a means of robust and reliable performance verification.

Rather than requiring or favoring a particular implementation, it is the goal of the SPC-2 benchmark specification to provide a robust, verifiable, reproducible environment within which the relative strengths of differing design and configuration approaches can be evaluated.

0.2 General Guidelines

The purpose of SPC benchmarks is to provide objective, relevant, and verifiable data to purchasers of I/O subsystems. To that end, SPC specifications require that benchmark tests be implemented with system platforms and products that:

1. Are generally available to users.
2. A significant percentage of the users in the target market segment (server class systems) would implement.
3. Are relevant to the market segment that the SPC-2 benchmark represents.

In addition, all SPC benchmark results are required to be sponsored by a distinctly identifiable entity, which is referred to as the Test Sponsor. The Test Sponsor is responsible for the submission of all required SPC benchmark results and materials. The Test Sponsor is responsible for the completeness, accuracy, and authenticity of those submitted results and materials as attested to in the required Letter of Good Faith (see Appendix A). A Test Sponsor is not required to be a SPC member and may be an individual, company, or organization.

The use of new systems, products, technologies (hardware or software) and pricing is encouraged so long as they meet the requirements above. Specifically prohibited are benchmark systems, products, and pricing (hereafter referred to as "implementations") whose primary purpose is performance optimization of SPC benchmark results without any corresponding applicability to real-world applications and environments. In other words, all "benchmark specials," implementations that improve benchmark results but not general, real-world performance are prohibited.

The following characteristics should be used as a guide to judge whether a particular implementation is a "benchmark special". It is not required that each point below be met, but that the cumulative weight of the evidence be considered to identify an unacceptable implementation. Absolute certainty or certainty beyond a reasonable doubt is not required to make a judgment on this complex issue. The question that must be answered is this: based on the available evidence, does the clear preponderance (the greater share or weight) of evidence indicate that this implementation is a "benchmark special"?

The following characteristics should be used to judge whether a particular implementation is a benchmark special:

- Is the implementation generally available, documented, and supported?
- Does the implementation have significant restrictions on its use or applicability that limits its use beyond SPC benchmarks?
- Is the implementation or part of the implementation poorly integrated into the larger product?
- Does the implementation take special advantage of the limited nature of SPC benchmarks (e.g., I/O Request profile, I/O Request mix, I/O Request concurrency and/or resource contention) in a manner that would not be generally applicable to the environment the benchmark represents?
- Is the use of the implementation discouraged by the vendor? (This includes failing to promote the implementation in a manner similar to the Test Sponsor's other products and technologies.)
- Does the implementation require uncommon sophistication on the part of the end-user, programmer, or system administrator?
- Is the packaging or pricing unusual or non-customary for the vendor or unusual or non-customary to normal business practices? The following pricing practices are suspect:
 - Availability of a discount to a small subset of possible customers.
 - Discounts documented in an unusual or non-customary manner.
 - Pricing featured as a close-out or one-time special.
 - Unusual or non-customary restrictions on transferability of product, warranty or maintenance on discounted items.
- Is the implementation being commonly used or purchased by a majority of end-users in the market area the benchmark represents? If the implementation is not currently being used by end-users, is there any evidence to indicate that it will be used by a significant number of users?

To assure the equitable application of this standard, the SPC has created a robust system of audit and peer review. It is the goal of the SPC to assure that only those results, which represent accurate and meaningful product performance, will be endorsed as official SPC results.

0.3 Measurement Guidelines

SPC benchmark results are expected to be accurate representations of subsystem performance. Therefore, stringent measurement, auditing, and reporting guidelines are mandated by this specification. In general, fidelity and candor must be maintained in reporting any items necessary to reproduce the reported results even if the items are not explicitly required to be disclosed by the SPC-2 benchmark specification.

More detailed measurement, evaluation and disclosure requirements can be found in the body of the specification.

0.4 Disclaimer

While the SPC-2 benchmark emulates a broad range of server applications, it neither represents the entire range of I/O requirements for server systems nor precisely mimics any particular application. In addition, the extent to which anyone is capable of achieving the results reported by a vendor is highly dependent upon how closely the customer's application maps to the SPC-2 workload. The extrapolation of SPC-2 results to other environments is therefore not recommended.

Actual system performance is highly dependent upon specific workload characteristics, platform configuration, and application-specific tuning. Relative system performance will vary as a result of these and other factors. Thus, SPC-2 should not be used as a substitute for customer application benchmarking when critical performance requirements are called for.

SPC-2 uses terminology and metrics that are similar to other benchmarks. This similarity does not imply that results from this benchmark are comparable with other benchmarks.

0.5 SPC Benchmark Series

SPC-2 is the second of a series of storage oriented system benchmarks. It utilizes a common SPC benchmark framework, which was also previously used by SPC-1.

Clause 1: Workload Environment

1.1 Business and Application Environment

SPC-2 is comprised of a set of I/O operations designed to demonstrate the performance of a storage subsystem when running business critical applications that require the large-scale, sequential movement of data. SPC-2 represents a segment of applications characterized predominately by large I/O's, organized into one or more concurrent sequential patterns. Frequently encountered examples of such applications include:

1. *Large file processing*: applications, in a wide range of fields, which require simple sequential processing of one or more large files. Specific examples include scientific computing and large-scale financial processing.
2. *Large database queries*: scans or joins of large relational tables, such as those performed for data mining or business intelligence.
3. *Video on demand*: individualized video entertainment provided to a community of subscribers, by drawing from a digital film library.

1.2 High-Level Workload Model

Each of the three categories of sequential workload just enumerated is considered to represent a widespread class of storage applications in itself, and also to be a useful indicator of sequential performance. Each of these three categories of sequential work also exhibits a distinctive set of sequential processing techniques being applied at the application level. SPC-2 therefore incorporates tests representative of all three of the identified categories of sequential work. Taking into account variations within the categories, SPC-2 incorporates a total of 19 individual tested workloads.

Tests of each workload are structured in a common way. Each workload defines a sequentially organized pattern of I/O requests, referred to as a Stream, which transfers a contiguous range of data (for example, a Stream might correspond to the reads or writes needed to transfer a specific file or to scan a specific table in a relational database). During SPC-2 test execution, the number of concurrent Streams of the defined type is varied, so as to observe the resulting range of data rates in megabytes per second. At least three different numbers of concurrent Streams are tested for each workload (a single stream, a maximum number of streams selected by the test sponsor, and an intermediate number of streams selected by the test sponsor). At the test sponsor's discretion, additional intermediate numbers of streams can be added to the test sequence.

The storage made available to the benchmark driver for use in running the SPC-2 benchmark is referred to as the Application Storage Unit (ASU). The ASU represents an abstraction of storage media and does not require a particular physical implementation. The physical implementation is determined by the Test Sponsor and must meet the storage configuration requirements stated in Clause 2: Data Repository. See Clause 4: Benchmark Configuration and Tested Storage Configuration for examples of supported configurations.

Clause 2: Data Repository

2.1 SPC-2 Storage Hierarchy

The SPC-2 data repository segments storage components into five distinct roles:

- Physical Storage Capacity (PSC) defined in Clause 2.2.
- Configured Storage Capacity (CSC) defined in Clause 2.3.
- Addressable Storage Capacity (ASC) defined in Clause 2.4.
- Logical Volumes (LV) defined in Clause 2.5.
- Application Storage Unit (ASU) Capacity defined in Clause 2.6.

The relationship between the different storage capacities is illustrated in Figure 2-1.

Included in the above storage capacities are:

- Storage required for data protection.
- Required Storage defined in Clause 2.3.2.
- Global Storage Overhead defined in Clause 2.2.3.
- Unused Storage defined in Clause 2.2.4.

Figure 2-1: SPC-2 Storage Hierarchy

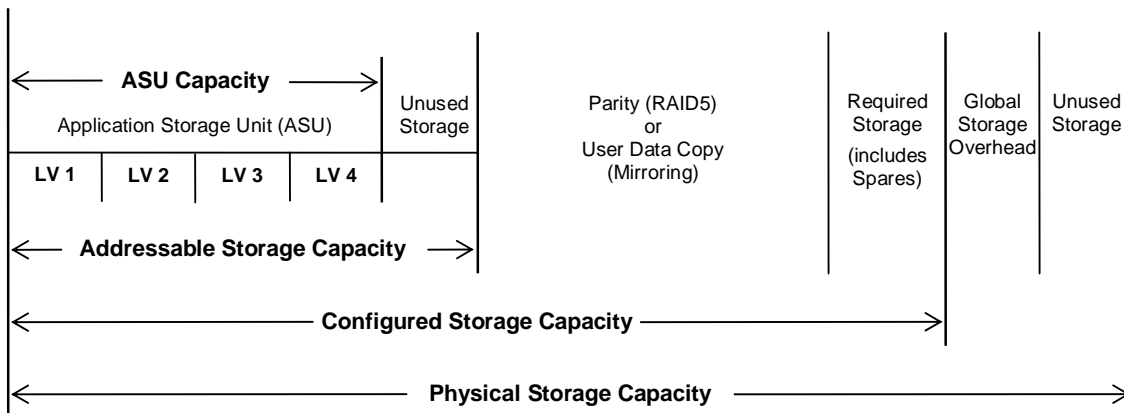

2.2 Physical Storage Capacity (PSC)

2.2.1 Physical Storage Capacity is typically the formatted capacity of all Storage Devices that are physically present in the Tested Storage Configuration.

2.2.1.1 In cases where the formatted capacity of a configured Storage Device is not publicly available information, the reported value will be the capacity reported as available for application use.

2.2.1.2 In cases where both the formatted capacity and the capacity available for application use are publicly available information, the Test Sponsor may choose to report either value. In such cases, the choice made by the Test Sponsor must be applied to all configured Storage Devices of the same model.

- 2.2.1.3 If the Test Sponsor reconfigures the capacity of a Storage Device as documented in Clauses 2.2.1.1 or 2.2.1.2 so that the resultant capacity is less than the original value, the difference is reported as Global Storage Overhead, as described in 2.2.3, and included in the reported Physical Storage Capacity.
- 2.2.2 All physical storage present in the TSC must be included in Physical Storage Capacity, whether or not it is cabled in or powered up.
- 2.2.3 Global Storage Overhead consists of the Physical Storage Capacity that is required for storage use, such as metadata, and unavailable for use by application programs such as the SPC-2 Workload Generator.
- 2.2.4 Unused Storage consists of the Physical Storage Capacity available for use but not included in the Required Storage/Spares, Parity/User Data Copy/Other Protection Level, Addressable Storage Capacity, and Unused Storage described in Clauses 2.3.2 and 2.4.3.
- 2.2.5 Physical Storage Capacity excludes any storage, with the exception of Global Storage Overhead, that cannot be configured for use by the benchmark.
- Comment:** The intent of this clause is to accurately disclose the physical storage that could be configured for application use, plus the storage reserved for system use and unavailable for application use. For example, this would exclude the difference between unformatted and formatted storage or storage devices that have failed.*
- 2.2.6 Physical Storage Capacity must be greater than or equal to Configured Storage Capacity.

2.3 Configured Storage Capacity (CSC)

- 2.3.1 Configured Storage includes the Addressable Storage Capacity and any other storage devices or components of storage devices necessary to implement the Addressable Storage Capacity described in Clause 2.4 (example: hot spares, parity disks, journal disks, log disks, etc.)
- 2.3.2 Unused Storage consists of the portion of Configured Storage Capacity available for use but not included in Required Storage/Spares, Parity/User Data Copy/Other Protection Level, Addressable Storage Capacity, and the Unused Storage described in Clause 2.4.3.
- 2.3.3 Required Storage/Spares consists of the amount of Configured Storage Capacity required to implement the Addressable Storage Capacity, excluding the storage required for the ASU and data protection.
- Examples of Required Storage include storage for metadata, required or optionally selected spares, etc.
- 2.3.4 Configured Storage Capacity must be equal to or greater than Addressable Storage Capacity.

2.4 Addressable Storage Capacity (ASC)

- 2.4.1 Addressable Storage Capacity represents the total storage that can be read and written by application programs on Host Systems and thus, is directly available for use by application programs that implement this benchmark.

- 2.4.2 Addressable Storage Capacity excludes any portion of the Configured Storage that is not available for use by an application program on Host Systems in the Benchmark Configuration.

***Comment:** The intent of this clause is to accurately disclose the storage that was configured for direct use by the benchmark as well as represent the amount of storage available for application use. For example, this would exclude the difference between the storage capacity used for storage management and not available for application use.*

- 2.4.3 Unused Storage is the difference between Addressable Storage Capacity and ASU Storage Capacity if they are not equal. This difference is counted twice if the Addressable Storage Capacity is mirrored

- 2.4.4 Addressable Storage Capacity must be less than or equal to the Configured Storage Capacity.

2.5 Logical Volumes (LV)

- 2.5.1 Logical Volumes (LV) represent the division of Addressable Storage Capacity into individually addressable logical units of storage used in the SPC-2 benchmark. Each Logical Volume must be implemented as a single contiguous address space.

- 2.5.2 Addressable Storage Capacity may contain one or more Logical Volumes.

- 2.5.3 The total capacity of all Logical volumes is equal to the Addressable Storage Capacity.

- 2.5.4 Examples of Logical Volumes include:

A single physical disk drive.

A partition on a single physical disk drive.

Multiple disk drives configured in an array.

A single logical partition on a multi-drive array.

Multiple, non-contiguous segments of one or more physical disk drives.

A virtual disk accessed via a Storage Area Network (SAN).

A RAM disk.

A hierarchy of any of the above.

2.6 Application Storage Unit (ASU)

- 2.6.1 The Application Storage Unit (ASU) represents a logical interface between the Data Repository and the host-based programs that implement this benchmark and provide the persistent non-volatile storage (see Clause 7: Data Persistence Requirements and Test) read and written in the course of executing the benchmark. The Logical Volume to ASU mappings that are permissible are illustrated in Figure 2-2 and must satisfy the requirements in Clauses 2.6.2 through 2.6.6.

Figure 2-2: ASU-to-Logical Volume Address Mappings

2.6.2 The ASU must be contained in a unique address space that is addressable by the workload generator as a contiguous set of logical blocks numbered from zero (0).

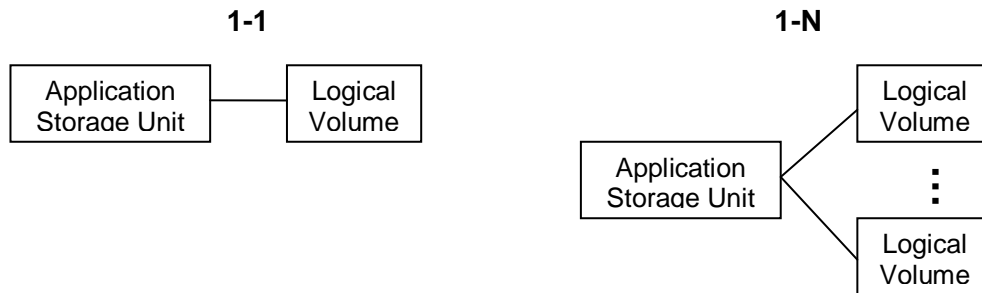

2.6.3 If the ASU is implemented on multiple Logical Volumes and the size of the ASU is smaller than the combined Logical Volumes, the ASU is not required to be evenly distributed across the Logical Volumes.

2.6.4 In the case of an ASU that is mapped to multiple Logical Volumes, the address mapping is a simple concatenation of volumes.

2.6.5 ASU Capacity consists of the Logical Volume storage capacity used to implement the required ASU. If any portion of a Logical Volume is not utilized by the ASU that portion of Logical Volume storage is not included in the ASU Capacity and is considered Unused Storage.

2.6.6 Total ASU Capacity must be less than or equal to total Logical Volume storage capacity.

2.7 Data Protection

2.7.1 Data protection is required and may be configured at any level of the SPC-2 Storage Hierarchy.

2.7.2 Data protection will be categorized in one of the following Data Protection Levels:

- **Protected 1:** The single point of failure of any storage device in the configuration will not result in permanent loss of access to or integrity of the SPC-2 Data Repository.
- **Protected 2:** The single point of failure of any component in the configuration will not result in permanent loss of access to or integrity of the SPC-2 Data Repository.

2.7.3 Data protection capacity will consist of all storage capacity configured for data protection, both used and unused.

2.8 Capacity Utilization

2.8.1 **Application Utilization** is defined as Total ASU Capacity divided by Physical Storage Capacity.

2.8.2 Protected Application Utilization is defined as (Total ASU Capacity plus total Data Protection Capacity minus unused Data Protection Capacity) divided by Physical Storage Capacity.

2.8.3 Unused Storage Ratio is defined as Total Unused Capacity divided by Physical Storage Capacity and may not exceed 45%.

Clause 3: Workload and I/O Operation Profile

3.1 Definitions

Although many parameters associated with an I/O workload are self-explanatory, there are several that are subject to interpretation, particularly when the intent of SPC-2 is to support multiple operating systems, hardware platforms and multiple workload instantiations. For this reason, some preliminary definitions are needed to minimize ambiguity and/or confusion. It should be noted that the scope of these definitions is limited to SPC-2.

3.1.1 Logical Block

A logical block is the smallest directly addressable unit of storage on the ASU. It is a fixed quantity of 512 bytes.

3.1.2 Logical Block Address (LBA)

The logical block address (LBA), which is sometimes known as the logical block number (LBN), specifies the address of a logical block on an ASU. For an ASU with a capacity of n logical blocks, it is a discrete value that ranges from a value of 0 (zero) for the first logical block on the ASU to a high of $n-1$ for the last logical block on the ASU.

3.1.3 Measurement Units

3.1.3.1 “Decimal” (*powers of ten*) Measurement Units

In the storage industry, the terms “kilo”, “mega”, “giga”, “tera”, “peta”, and “exa” are commonly used prefixes for computing performance and capacity. For the purposes of the SPC workload definitions, all of these terms are defined in powers of 10. Specifically:

- A kilobyte (KB) is equal to 1,000 (10^3) bytes.
- A megabyte (MB) is equal to 1,000,000 (10^6) bytes.
- A gigabyte (GB) is equal to 1,000,000,000 (10^9) bytes.
- A terabyte (TB) is equal to 1,000,000,000,000 (10^{12}) bytes.
- A petabyte (PB) is equal to 1,000,000,000,000,000 (10^{15}) bytes
- An exabyte (EB) is equal to 1,000,000,000,000,000,000 (10^{18}) bytes

3.1.3.2 “Binary” (*powers of two*) Measurement Units

The sizes reported by many operating system components use “power of two” measurement units rather than “power of ten” units. The following standardized definitions and terms are also valid and may be used in this specification.

- A kibibyte (KiB) is equal to 1,024 (2^{10}) bytes.
- A mebibyte (MiB) is equal to 1,048,576 (2^{20}) bytes.
- A gibibyte (GiB) is equal to 1,073,741,824 (2^{30}) bytes.
- A tebibyte (TiB) is equal to 1,099,511,627,776 (2^{40}) bytes.
- A pebibyte (PiB) is equal to 1,125,899,906,842,624 (2^{50}) bytes.
- An exbibyte (EiB) is equal to 1,152,921,504,606,846,967 (2^{60}) bytes.

3.2 SPC-2 Workload Components

SPC-2 is comprised of several distinct components, layered from highest to lowest level as follows:

SPC-2 Working Set: One Application Storage Unit.

Application Storage Unit Stream: A variable number of *I/O Streams*.

I/O Stream: A single, well-defined, sequence of *I/O Commands*.

I/O Command or I/O Request: A single atomic unit of work to the Application Storage Unit.

3.2.1 SPC-2 Workload

The SPC-2 workload consists of one or more Application Storage Unit streams and represents the entire I/O workload.

3.2.2 Application Storage Unit (ASU) Stream

An Application Storage Unit stream consists of one or more I/O streams, and completely defines the I/O sent to the SPC-2 ASU.

3.2.3 I/O Stream

An I/O stream consists of the results of the execution of a sequence of one or more I/O commands. This I/O stream is initiated at a specific point during the I/O workload, and has a specific life. The sequence of individual commands within the I/O stream is fully defined by the workload parameters associated with the SPC-2 workload. One definition is required for each I/O stream contained in the SPC-2 workload, and is sufficient to characterize every I/O associated with that I/O stream.

3.2.4 I/O Command or I/O Request

An I/O command (or I/O Request) is the lowest level in the SPC-2 workload hierarchy. It completely defines a single command that transfers data to or from an Application Storage Unit. It is an entity that contains sufficient information to enable the SPC workload generator to issue an I/O operation to the Application Storage Unit in conformance with the SPC-2 workload.

As an example, an I/O command might contain the following items:

- Application Storage Unit identifier.

- The starting address of the data transfer.

- The byte count of the data transfer.

- The type of data transfer (read or write).

- A pointer to a buffer for transmission (writes) or reception (reads) of data.

3.3 SPC-2 Parameter Types

Each SPC-2 workload parameter is defined as being one of the following types.

3.3.1 Integer

An integer parameter is capable of storing discrete, signed values. The range is operating system and/or compiler dependent, but must be a minimum of 32 bits, including the sign bit (-2,147,483,648 to 2,147,483,647).

3.3.2 Long Integer

A long integer parameter is capable of storing discrete, signed values. The range is operating system and/or compiler dependent, but must be a minimum of 64 bits, including the sign bit (-9,223,372,036,854,775,808 to 9,223,372,036,854,775,807).

3.3.3 Real

A real parameter is capable of storing positive and negative continuous values. The range is operating system and/or compiler dependent, but must have a minimum range of from -10^{32} to 10^{32} with a minimum resolution of 16 significant digits.

3.3.4 ASCII string

An ASCII string parameter consists of a variable length sequence of ASCII characters (8 bits per character), with a zero byte terminating the string.

3.3.5 Distribution

The distribution is a special data type that has been implemented specifically for the SPC workload parameter list. This parameter contains sufficient information to characterize a distribution that may be used for certain parameters. This data type consists of several components.

3.3.5.1 Distribution type

The type of distribution is indicated by an integer variable. The legal types of distributions are:

- 0: Constant – A single number. The value of this number is contained in the first element of the distribution parameter list.
- 1: Uniform – A number that is uniformly distributed between (and including) two values. The lower of these values is contained in the first element of the distribution parameter list, and the upper value is contained in the second element.
- 2: Exponential – A number that is exponentially distributed with a mean value contained in the first element of the distribution parameter list.
- 3: Table – A table distribution is an n-dimensional array containing the discrete table values. There is no limit on the number of dimensions or entries in the array. The pointer component (section) of the distribution data type points to the start of the array. The contents of the array are undefined, and must be specified for each case.
4. Sparse Incremental: An ascending series of values. This distribution has two associated parameters, *sparse incremental (start, length)*.

The first parameter “start”, defines the first value of a monotonically increasing sequence. “start” is an integer representing the block address location within the ASU address range that the sequence begins. The sequence will increase until “length” has been traversed, and then begin again at a new first value, repeating.

The second parameter, “length” which, is required, is used to define the range of addresses of the generated sequence. “Length” is an integer representing the number of blocks of the ASU address space over which the sequence is generated. “Length” is added to each new computed first value to determine the upper address of the series.

If “Sparse Incremental” is used to generate a sequence of addresses for a stream of I/O references, the number of values in the sequence is controlled by the start and stop criteria of the I/O stream.

In the context of SPC-2, the aforementioned parameters are restricted in value in an attempt to minimize the performance benefits derived from cache as a result of reference locality. For the SPC-2 workloads consisting of multiple simultaneous IO streams, the ASU address range is sparsely traversed by each of the streams to limit temporal re-references.

As new distributions become necessary, they will be added to this list in a monotonically increasing sequence.

3.3.5.2 Result type

The result type indicates whether the resulting value from the distribution is integer or real. There are three possible values for this field:

- 0: Integer – The output of the distribution is an integer.
- 1: Long - The output of the distribution is a long integer.
- 2: Real – The output of the distribution is a real number.

3.3.5.3 Distribution parameter list

The distribution parameters consist of a list of ten real numbers. The values contained in these fields may be used as part of the distribution function. The number of values that are used is function dependent, and may range from none to all ten.

3.3.5.4 Extended pointer

The extended pointer is used when it is necessary to include more than ten discrete parameters or when a singly dimensioned list is not adequate. The primary use of this pointer is when a table distribution is required. The data structure that is pointed to by this element is not defined by this document.

3.4 SPC-2 Workload Parameters

A set of parameters is required for each I/O stream that is present in the SPC-2 workload. These parameters are passed to the SPC-2 Workload Generator. The set of parameters will enable the SPC-2 Workload Generator to create and submit a stream of I/O requests to the SPC-2 Application Storage Unit.

Conceptually, the SPC-2 Workload Generator will examine the parameters, and by using the values contained in these parameters, generate a sequence of I/O commands, with each individual command being issued at the appropriate time.

3.4.1 I/O Buffers

The I/O Buffers parameter specifies the number of buffers utilized for each Stream in the Video On Demand (VOD). Each buffer is the target of the I/O Requests submitted by the SPC-2 Workload Generator.

3.4.1.1 Parameter Type

The I/O Buffers parameter is an integer variable.

3.4.1.2 Acceptable Values

The I/O Buffers parameter value must be greater than zero.

3.4.2 I/O Buffer Read Interval

The I/O Buffer Read Interval parameter specifies the required interval between I/O Requests issued to the I/O Buffers for each VOD Stream. The interval represents the time to read (“consume”) each I/O Buffer.

3.4.2.1 Parameter Type

The I/O Buffer Read Interval parameter is a real (floating point) variable.

3.4.2.2 Acceptable Values

The I/O Buffer Read Interval is a positive real (floating point) value greater than zero.

3.4.3 Model Type

The model type parameter indicates whether the I/O stream follows an open or closed model.

(If the input is external to and independent of the model, it is an open model. In a closed model, there is no external input)

3.4.3.1 Parameter Type

The model type is an integer variable.

3.4.3.2 Acceptable Values

The model type parameter may take on one of the following values representing the workload type:

Open

Closed

3.4.4 Outstanding I/O Requests

The Outstanding I/O Requests parameter specifies the maximum number of concurrent I/O Requests, associated with a given stream, which have been issued but not yet completed.

3.4.4.1 Parameter Type

The Outstanding I/O Requests parameter is an integer variable.

3.4.4.2 Acceptable Values

The Outstanding I/O Requests parameter is a positive integer constant.

3.4.5 Read Fraction

The read fraction parameter specifies the fraction of I/O commands that are reads.

3.4.5.1 Parameter Type

The read fraction parameter is a distribution of real (floating-point) variables.

3.4.5.2 Acceptable Values

The read fraction parameter may take on any positive real (floating point) value greater than or equal to zero and less than or equal to one.

3.4.6 Transfer Address

The transfer address parameter determines the target address of the next I/O that will be issued to the ASU. Note that bounds checking must be performed to ensure that the resulting address is greater than or equal to zero, and that the sum of the address and transfer size is less than or equal to the capacity of the ASU.

3.4.6.1 Parameter Type

The transfer address parameter is a distribution variable.

3.4.6.2 Acceptable Values

The transfer address value must be greater than or equal to zero, and the sum of the transfer address and the transfer size must be less than or equal the capacity of the ASU.

3.4.7 Transfer Size

The transfer size parameter specifies the number of KiB to transfer.

3.4.7.1 Parameter Type

The transfer size parameter is a distribution of long integer variables.

3.4.7.2 Acceptable Values

In the SPC-2 benchmark, all streams use a transfer size specified as a positive integer constant.

3.4.8 Workload Identifier

The workload identifier, which is unique for all I/O streams in the benchmark, is a value assigned by the SPC to identify a specific workload. The purpose of this parameter is to allow an analysis program to extract performance information for a specific workload from a test that includes more than one workload (i.e. an entire benchmark run).

3.4.8.1 Parameter Type

This parameter is a variable length, zero terminated, ASCII string.

3.4.8.2 Acceptable Values

No restriction is placed on this parameter.

3.5 Technical Workload Description

SPC-2 represents a segment of applications characterized by predominately sequential I/O operations as typified by large file reads and writes, large database scans and video on demand, but not limited to these specific application types.

The storage for the SPC-2 workload consists of a single Application Storage Unit (ASU).

The ASU is the target of all streams that in turn comprise the benchmark. The I/O streams for each workload are defined below by a set of parameters and associated values. Definitions and descriptions of each parameter type used to define the SPC-2 parameters may be found in Clause 3.4.

3.5.1 Workload 1 – Large File Processing

This workload represents large file read and write activity such as that encountered when processing large CAD files.

***Comment:** The intent of Large File Processing 4-6, as described in Table 3-1, is that those workloads reflect the behavior that occurs during file copy operations. For each Sparse Incremental Read stream, the SPC-2 Workload Generator will select a statistically independent Sparse Incremental Write stream. The I/O requests generated by the SPC-2 Workload Generator will then alternate between the two streams. The combined number of outstanding I/O requests to both streams is limited to the maximum shown in Table 3-1.*

Table 3-1: Large File Processing (LFP) Parameter Types and Values

Workload Description	Transfer Size	Read Fraction	Model Type	Transfer Address	Outstanding I/O Requests		Workload ID
Large File Processing 1 (Write Only)	1024 KiB	0.0	Closed	Sparse Incremental (s,l)	1		SPC-2-FP
Large File Processing 2 (Write Only)	256 KiB	0.0	Closed	Sparse Incremental (s,l)	1		SPC-2-FP
Large File Processing 3 (Read-Write)	1024 KiB	0.5	Closed	Sparse Incremental (s,l)	1		SPC-2-FP
Large File Processing 4 (Read-Write)	256 KiB	0.5	Closed	Sparse Incremental (s,l)	1		SPC-2-FP
Large File Processing 5 (Read only)	1024 KiB	1.0	Closed	Sparse Incremental (s,l)	1		SPC-2-FP
Large File Processing 6 (Read Only)	256 KiB	1.0	Closed	Sparse Incremental (s,l)	1		SPC-2-FP

3.5.2 Workload 2 – Large Database Queries

This workload represents the IO activity encountered during queries of very large databases.

Comment: *The intent of the Write activity in the Large Database Query workload is to reflect the behavior of queries that produce a temporary table as output. The SPC-2 Workload Generator will select a statistically independent, Sparse Incremental Write stream for each Sparse Incremental Read stream. The SPC-2 Workload Generator will select at random which of the two streams will be the target of a given I/O request such that the percentage of I/O's stated in Table 3-2 will consist of Read I/O requests and the remaining percentage will be Write I/O requests. The combined number of outstanding I/O requests to both streams will be limited to the maximum shown in Table 3-2.*

Table 3-2: Large Database Query (LDQ) Parameter Types and Values

Workload Description	Transfer Size	Read Fraction	Model Type	Transfer Address	Outstanding I/O Requests		Workload ID
Large Database Queries: 4 Outstanding I/Os	1024 KiB	0.99	Closed	Sparse Incremental (s,l)	4		SPC-2-DQ
Large Database Queries: 1 Outstanding I/O	1024 KiB	0.99	Closed	Sparse Incremental (s,l)	1		SPC-2- DQ
Large Database Queries: 4 Outstanding I/Os	64 KiB	0.99	Closed	Sparse Incremental (s,l)	4		SPC-2- DQ
Large Database Queries: 1 Outstanding I/O	64 KiB	0.99	Closed	Sparse Incremental (s,l)	1		SPC-2- DQ

3.5.3 Workload 3 – Video On Demand

This workload represents the IO activity encountered during the delivery of streaming video. Specifically,

Table 3-3: Videos on Demand (VOD) Parameter Types and Values

Workload Description	Transfer Size	Read Fraction	Model Type	Transfer Address	I/O Buffers	I/O Buffer Read Interval	Workload ID
Video On Demand	256 KiB	1.0	Closed	Sparse Incremental (s,l)	8	23 IOPS	SPC-2-VOD

Clause 4: Benchmark Configuration and Tested Storage Configuration

4.1 Definitions

- 4.1.1 The Benchmark Configuration (BC) consists of all hardware and software components used in the execution of the SPC-2 benchmark.
- 4.1.2 The Tested Storage Configuration (TSC) consists of all software and hardware necessary to implement and support the configured Application Storage Unit (ASU) as defined in Clause 2.6.

4.2 Benchmark Configuration Component Availability and Support

All hardware and software used in the Benchmark Configuration must be commercially available and supported either as individual items or as a part of a larger package. Hardware and software used in the Benchmark Configuration that is NOT included in the Tested Storage Configuration is exempt from the preceding requirement if it is no longer commercially available and/or supported due to obsolescence.

Comment: The intent is to allow the use of components in the Benchmark Configuration that were at one time commercially available and supported as long as the components are not a part of the Tested Storage Configuration.

4.3 Benchmark Configuration Components

4.3.1 Host System

- 4.3.1.1 The Host System(s) consist of one or more computer systems where the the SPC-2 Workload Generator executes.
- 4.3.1.2 The Host System is responsible for organizing and managing the underlying Logical Volumes used to implement the ASU.
- 4.3.1.3 The Host System(s) shall not cache or buffer any data associated with implementing the ASU on the BC nor be used to cache or buffer any ASU data.

4.4 Benchmark Configuration Examples

SPC-2 Test Sponsors may utilize a wide range of Benchmark Configurations. The diagrams in Figure 4-1 and Figure 4-2 are examples of acceptable Benchmark Configurations, but should not be considered as the only valid Benchmark Configurations.

A Test Sponsor may utilize a configuration that is different from the examples illustrated below. In such a case, the Test Sponsor is encouraged to contact the SPC prior to engaging in an Audit to ensure the proposed configuration will meet the SPC-2 benchmark requirements.

Figure 4-1: Benchmark Configuration – Direct Attach Storage Controller

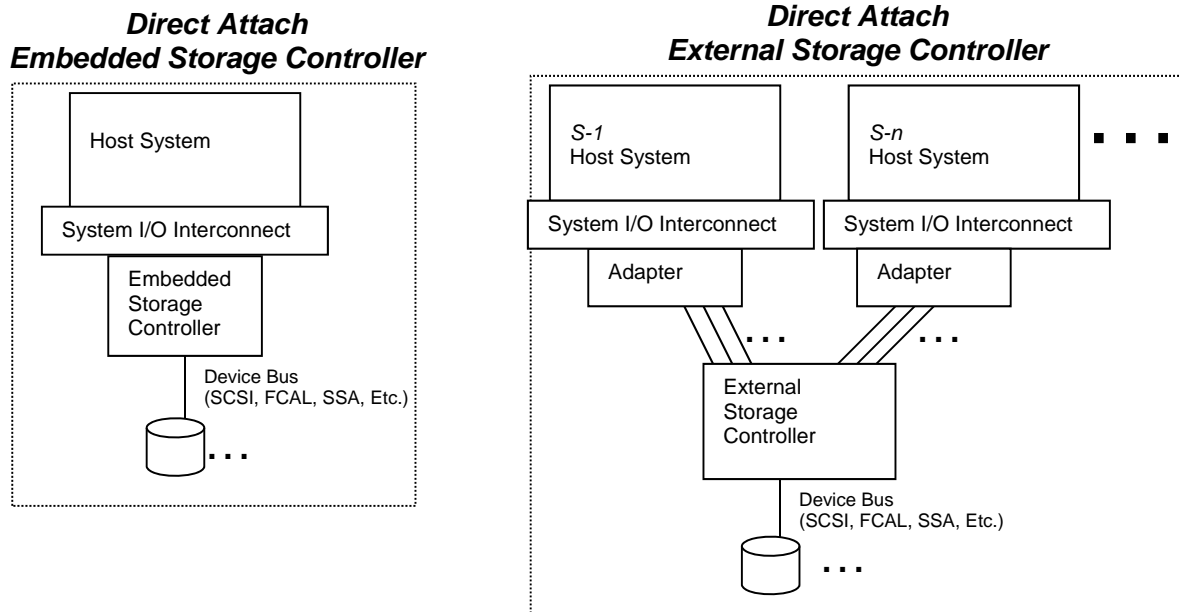
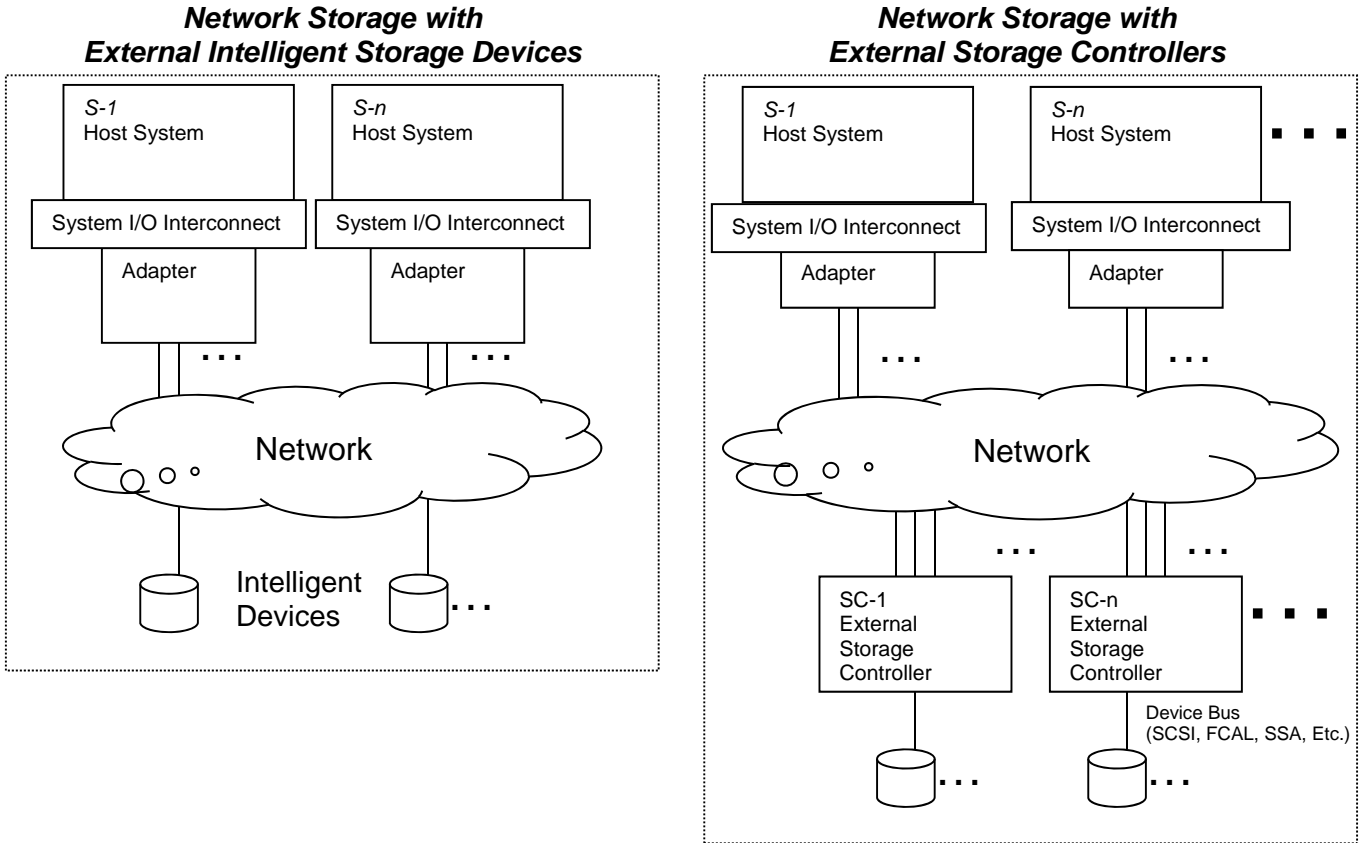

Figure 4-2: Benchmark Configuration – Network Storage



4.5 Tested Storage Configuration Components

4.5.1 Host System Inclusion

Each Host System in the Benchmark Configuration (BC) must be included as a Tested Storage Configuration (TSC) component if any of the following conditions are true:

1. The Host System contains an integral component that is a TSC hardware component, which cannot be unplugged and moved to a different Host System.
2. The Host System includes physical storage devices that contain the configured SPC-2C Data Repository (*Clause 2*) and are connected internally as integral Host System components.
3. The Host System(s) implements TSC data protection functionality, as required in *Clause 2.7*.

An example of a TSC that includes the Host System as a TSC component is described in *Clause 4.5.3.2* and illustrated in *Figure 4-3*.

Host System(s) may provide one or more of the following functionalities and not be included as a priced TSC component:

- Organize and manage the underlying Logical Volumes that comprise the Application Storage Unit (ASU);
- Provide RAID-0 (striping) functionality provided that the alignment of an I/O is a multiple of its Transfer Size and the stripe unit size is a multiple of the largest Transfer Size in the benchmark.

Comment: *It is intended that the I/O Requests issued by the SPC-2 Workload Generator be unaltered when passed through any Volume Manager striping. This means that the I/O Requests cannot be partitioned into a unit smaller than nor larger than the Transfer Size specified in *Clause 3.4.7*.*

*The generated I/O Request is constrained to be memory and LBA aligned to an exact multiple of the Transfer Size specified in *Clause 3.4.7*. Selection of a stripe unit size that is at least as large as the largest Transfer Size and is an exact multiple of the largest Transfer Size should meet this requirement.*

Stripe unit size (segment size) is the number of 512 byte blocks access on one device in the stripe before transitioning to the next device in the stripe.

Test Sponsors should request a recommendation from the Compliance Review Committee if the above wording does not clarify the TSC component status of a Host System in their Benchmark Configuration.

4.5.2 Multiple Storage Subsystem Configurations

A Test Sponsor may choose to configure multiple, independent storage subsystems in a Benchmark Configuration. In such a Benchmark Configuration, the multiple, independent storage subsystems must comprise an actual orderable storage configuration that a customer would purchase and not a collection of orderable products.

In such a configuration, the Application Storage Unit will be configured across the storage subsystems and meet the requirements of *Clause 2: Data Repository*.

Comment: It is the intent of this clause that multiple, independent storage subsystems not be configured as a TSC solely for the purpose of this benchmark, which is prohibited in Clauses 0.2 and 9.2.2.1. A TSC that comprised of multiple, independent storage subsystems will be evaluated based on Clauses 0.2 and 9.2.2.1 for compliance with this clause.

4.5.3 Tested Storage Configuration (TSC) Examples

Clauses 4.5.3.1 – 4.5.3.3 describe and illustrate, in detail, several typical Tested Storage Configurations, including the boundary between the Host System and TSC (TSC Boundary). Those examples should not be considered the only valid Tested Storage Configurations.

A Test Sponsor may utilize a configuration that is different from the examples described and illustrated in Clauses 4.5.3.1 – 4.5.3.3. In such a case, the Test Sponsor is encouraged to contact the SPC prior to engaging in an Audit to ensure the proposed configuration will meet the SPC-2 benchmark requirements.

4.5.3.1 Embedded Storage Controller – External Storage Devices

A TSC that utilizes an embedded storage controller and external storage devices is illustrated in Figure 4-3.

Figure 4-3: Embedded Storage Controller – External Storage Devices

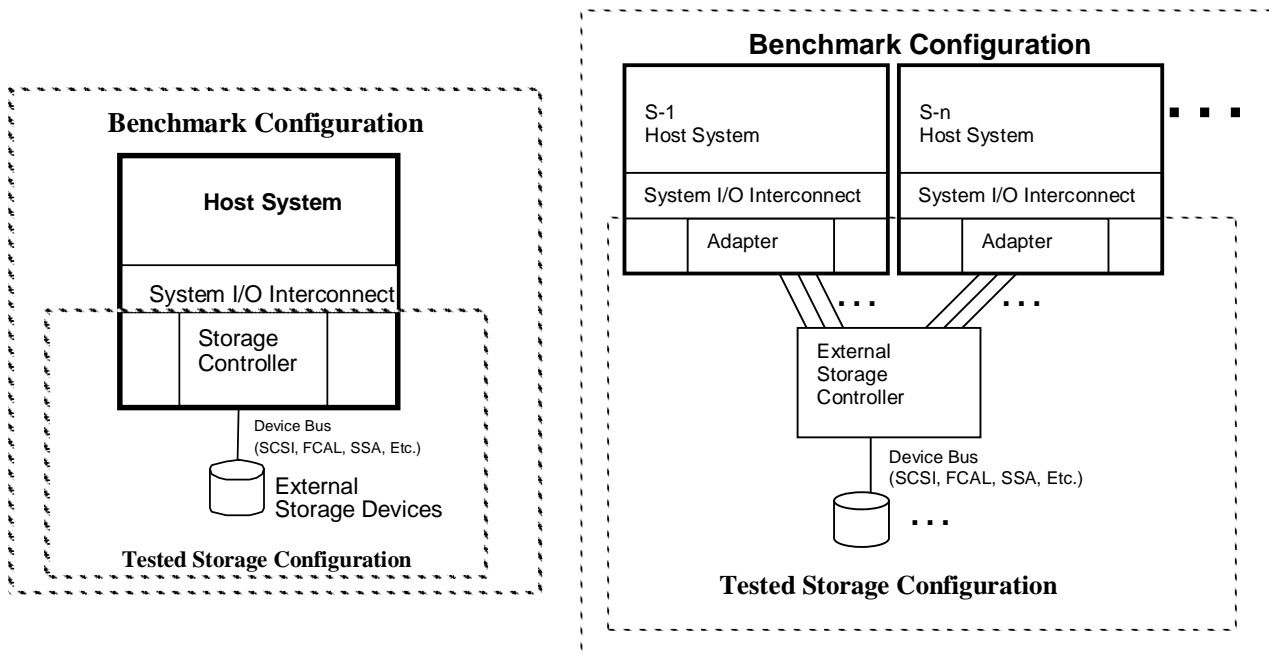

The components that comprise the TSC typically include:

1. A storage controller that plugs into a system I/O interconnect on the Host System.
2. Batteries used to maintain power to cache/memory in the storage controller in the event of unexpected power failure.
3. Cabling between the storage controller and the storage devices used to implement the ASU.

4. All cabinetry used to house components of the TSC (excluding the cabinetry, cooling, power, and monitoring systems required to house the storage controller embedded in the Host System cabinet).
5. Environmental monitoring systems and related cabling used to monitor the health of components of the TSC.
6. Fans used to cool components of the TSC.
7. Power supplies and related cabling used to power components of the TSC.
8. Power distribution systems and related cabling in cabinetry used to route power to the individual component power supplies in the TSC.
9. All management software necessary to present the ASU to the SPC-2 Workload Generator.
10. Storage devices (e.g., disks) to provide the various levels of storage described in Clause 2: Data Repository.

4.5.3.2 Embedded Storage Controller – Embedded Storage Devices

A TSC that utilizes Host System components is illustrated in Figure 4-4.

Figure 4-4: Embedded Storage Controller – Embedded Storage Devices

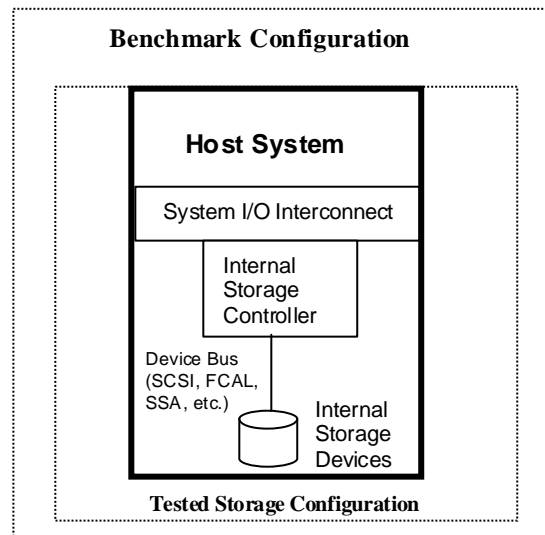

The components that comprise the TSC typically include:

1. A storage controller that either plugs into a system I/O interconnect on the Host System or is an integral Host System component.
2. Batteries used to maintain power to cache/memory in the storage controller in the event of unexpected power failure.
3. Storage devices (e.g., disks) to provide the various levels of storage described in Clause 2: Data Repository. The storage devices may either be connected externally to the Host System or connected internally as an integral Host System component.
4. Cabling between the storage controller and the storage devices used to implement the ASU.

5. All cabinetry used to house components of the TSC.
6. Environmental monitoring systems and related cabling used to monitor the health of components of the TSC.
7. Fans used to cool components of the TSC.
8. Power supplies and related cabling used to power components of the TSC.
9. Power distribution systems and related cabling in cabinetry used to route power to the individual component power supplies in the TSC.
10. All management software necessary to present the ASU to the SPC-2 Workload Generator.

4.5.3.3 Network Storage - External Storage Controller and External Storage Devices

A network storage TSC utilizing external storage controllers and external storage devices is illustrated in Figure 4-5.

Figure 4-5: Network Storage and External Storage Controller

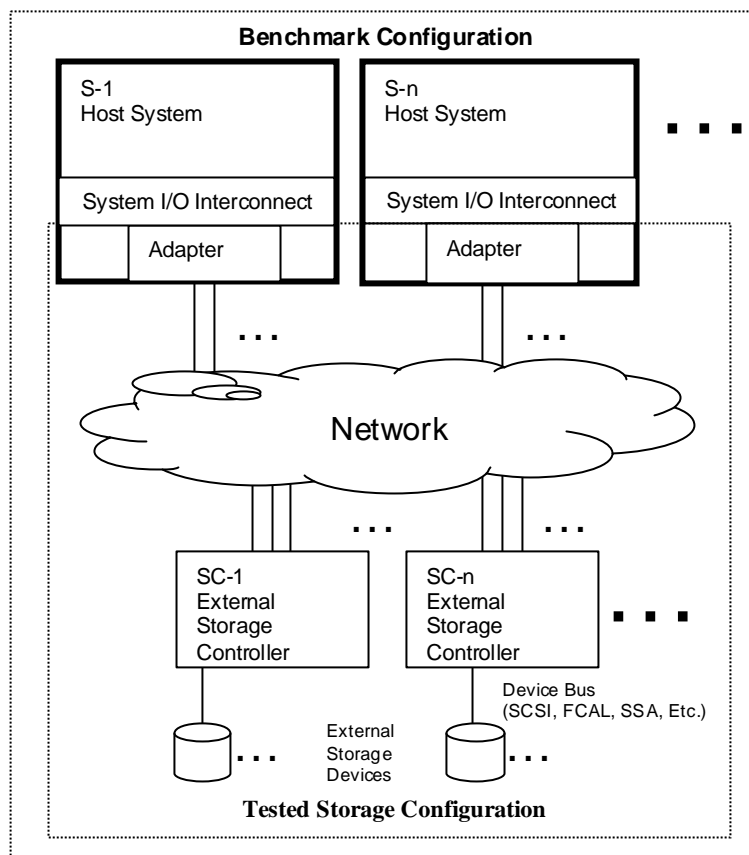

The TSC typically includes the following components:

1. One or more host bus adapters that connect the storage network into system I/O interconnect(s) on the Host System(s).

2. All network infrastructure including hubs, switches, bridges, routers, cables, connectors, as well as supporting cabinetry, cooling, power systems, and monitoring equipment/systems used to connect the storage controllers to the Host Systems.
3. All software used to manage and maintain the network infrastructure.
4. External storage controllers or domain controllers including:
 - a) Batteries used to maintain power to write cache in the storage controller in the event of unexpected power failure.
 - b) Cabinetry used to house the storage controller.
 - c) Monitoring systems and related cabling used to monitor the health of the storage controller.
 - d) Equipment used to cool the storage controller.
 - e) Power supplies and related cabling used to power the storage controller.
 - f) Power distribution systems and related cabling used to route power to the storage controllers.
 - g) All management software necessary to allow the storage controller to present the ASU to the SPC-2 Workload Generator.
5. Storage devices (e.g., disks) to provide the various levels of storage described in Clause 2: Data Repository.
6. Cabling between the storage controller and the storage devices.
7. Cabinetry used to house the storage devices.
8. Monitoring systems and related cabling used to monitor the health of the storage devices.
9. Equipment used to cool the storage devices.
10. Power supplies and related cabling used to power the storage devices.
11. Power distribution systems and related cabling used to route power to the individual storage device power supplies.
12. All management software necessary to present and manage the ASUs to the SPC-2 Workload generator.

4.6 Tested Storage Product (TSP)

The Tested Storage Product (TSP) is a distinct, customer orderable product, which is the focal point of a SPC-2 result. Each SPC-1 result will be labeled with the formal name of the TSP (Clause 10.6.1).

Clause 5: SPC-2 Workload Generator

5.1 Overview

A SPC-2 result must be produced using the current SPC-2-Workload Generator kit. The current SPC-2 Workload Generator kit is available from the SPC to Test Sponsors in machine executable format.

The SPC-2 Workload Generator is a user-space application, instantiated by one or more processes running on one or more Host Systems. The SPC-2 Workload Generator is capable of referencing any block within the configured capacity of the Application Storage Unit (ASU).

Functions of the SPC-2 Workload Generator include:

- Generating I/O Requests based on the workload parameters defined in Clause 3.5.
- Issuing those I/O Request to the ASU.
- Receiving completed I/O Request notification from the ASU.
- Performing error checking and time stamping for the I/O Requests.
- Generating test results for each benchmark Test Run.

5.2 Multiple Host System Configurations

5.2.1 Multiple Host System Configuration Requirements

If a Test Sponsor chooses to configure multiple Host Systems in a Benchmark Configuration the following requirements must be met:

- Each Host System must have access to and utilize the entire ASU.
- Each Host System must maintain the workload parameter requirements defined in Clause 3.5.
- The aggregate workload presented by the multiple Host System configuration must maintain the workload parameter requirements defined in Clause 3.5.
- The workload presented from the Host Systems must be synchronized in time.
- The measurement results from a multiple Host System configuration must be equivalent to the results generated by a comparable single Host System configuration when using the same TSC.

Comment: *It is the intent of this clause that multiple Workload Generators spread across multiple Host Systems effectively behave as a single Workload Generator relative to the workload offered to the TSC.*

5.2.2 Stream Allocation – Multiple Host System Configurations

- 5.2.2.1 The SPC-2 Workload Generator will allocate Streams in a “round-robin” fashion among the Host Systems in a Multiple Host System Configuration.
- 5.2.2.2 The Test Sponsor is allowed to set a maximum Stream count for each Host System in a Multiple Host System Configuration.
- 5.2.2.3 If the number of Streams allocated to a Host System equals the maximum Stream count set by the Test Sponsor for that Host System, no additional Streams will be allocated to the Host System for the current Test Run.

5.3 Application Storage Unit (ASU) Access

The SPC-2 Workload Generator is not allowed to utilize any file system functionality, such as caching or pre-fetching, provided by the Host System(s) when accessing the ASU. As an example, the UNIX implementations of the SPC-2 Workload Generator will issue I/O Requests via the raw, unblocked I/O interface. Figure 5-2 illustrates that example.

All other operating system implementations of the SPC-2 Workload Generator will utilize the operating system's mechanisms for performing I/O that matches as closely as possible the raw, unblocked I/O interface provided by UNIX.

5.4 Transfer Address Determination

The SPC-2 Workload Generator shall determine a Transfer Address for each I/O Request that is aligned to a multiple of the Transfer Size. See Clause 3.5 regarding the specific parameters applicable to the SPC-2 Workload Generator operation.

5.5 Measurement Boundary

The Measurement Boundary for computing SPC-2 results is primarily defined by the implementation of the SPC-2 Workload Generator as illustrated in Figure 5-1 and Figure 5-2.

The Measurement Boundary occurs within the SPC-2 Workload Generator where start and completion times of I/O Requests are recorded.

Figure 5-1: Measurement Boundary

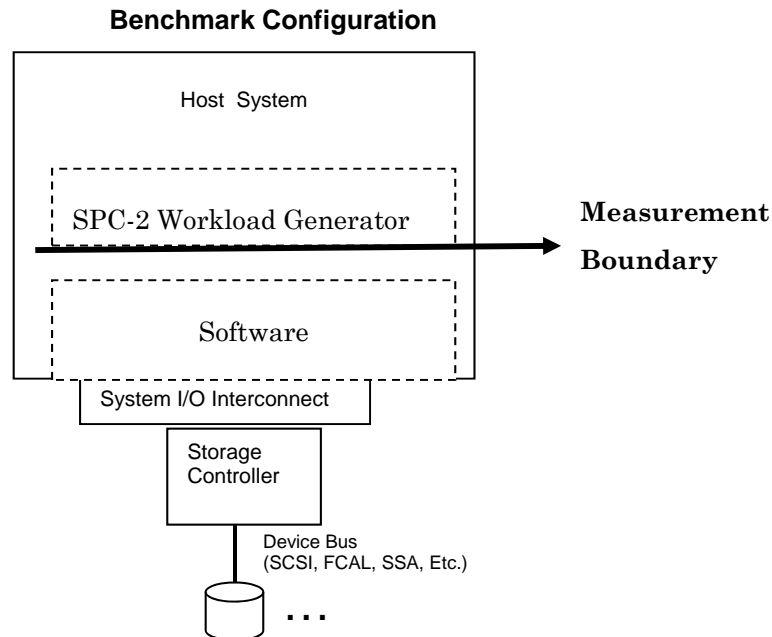
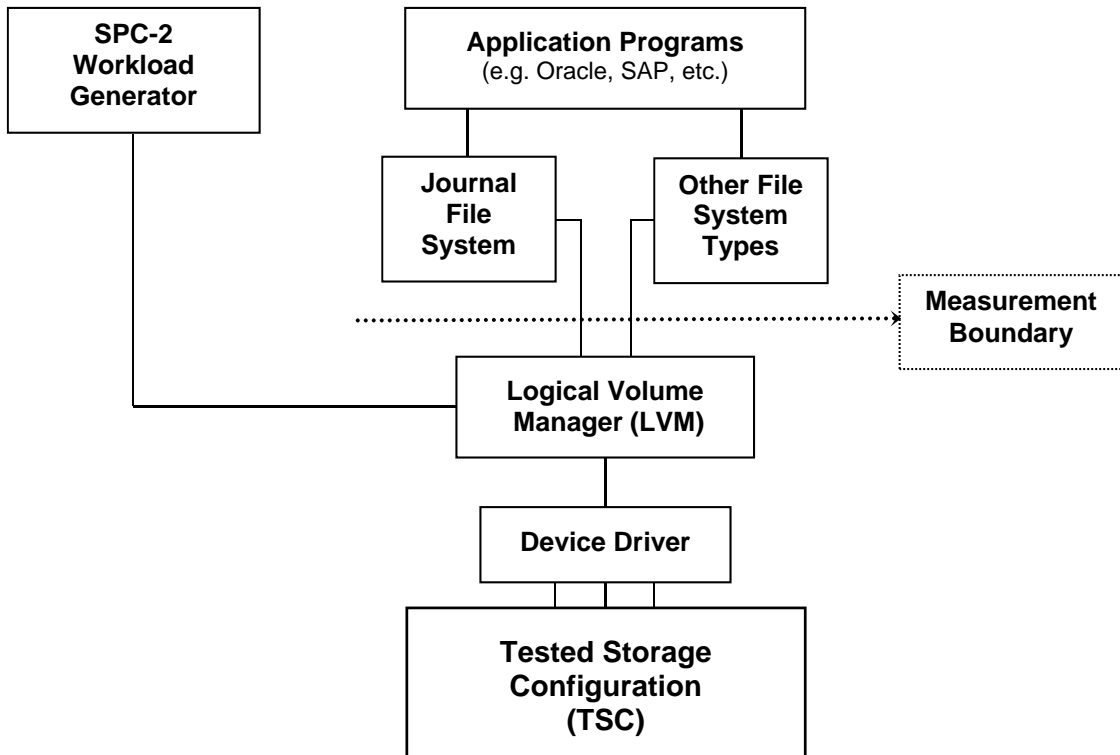

Figure 5-2: Measurement Boundary in an UNIX System Implementation



Clause 6: Test Measurement Requirements (Execution Rules)

6.1 Supporting Definitions

- 6.1.1 Completed I/O Request: An I/O Request with a Start Time and a Completion Time (see Figure 6-2).
- 6.1.2 Completion Time: The time recorded by the Workload Generator when an I/O Request is completed by the Tested Storage Configuration (TSC).
- 6.1.3 Data Rate: The data volume, in MB, transferred by all Measured I/O Requests in an SPC-2 Test Run divided by the length of the Test Run in seconds.
- 6.1.4 Failed I/O Request: Any I/O Request issued by the SPC-2 Workload Generator that meets one of the following conditions (see Figure 6-2):
- The I/O Request was signaled as failed by the operating system on a Host System.
 - The I/O Request started within the Measurement Interval, but did not complete prior to the end of the appropriate Run-Out period.
 - The I/O Request started within the Run-Out period, but did not complete prior to the end of the appropriate Ramp-Down period.
- 6.1.5 I/O Request Throughput: The total number of Measured I/O requests in an SPC-2 Test Run divided by the duration of the Measurement Interval in seconds.
- 6.1.6 Measured I/O Request: A Completed I/O Request that begins (Start Time) within a Measurement Interval and completes (Completion Time) prior to the end of the appropriate Ramp Down (see Figure 6-2).
- 6.1.7 Measurement Interval: A specified, contiguous period of time, after the TSC has reached Steady State, when data is collected by the Workload Generator to produce the test results for a SPC-2 Test Run (see Figure 6-1; Test Run 1: T₂-T₃ and Test Run 2: T₇-T₈).
- 6.1.8 Outstanding I/O Request: A workload parameter defined in Clause 3.4.3.
- 6.1.9 Ramp-Down: A specified, contiguous period of time in which the TSC is required to complete I/O Requests started but not completed during the preceding Run-Out period. Ramp-Down begins at the end of the preceding Run-Out period (see Figure 6-1: Test Run 1: T₄-T₅ and Test Run 2: T₉-T₁₀). The Workload Generator will not submit any I/O Requests during the Ramp-Down.
- 6.1.10 Ramp-Up: A specified, contiguous period of time required for the Benchmark Configuration (BC) to produce Steady State throughput after the Workload Generator begins submitting I/O Requests to the TSC for execution. The Ramp-Up period ends at the beginning of the Measurement Interval (see Figure 6-1; Test Run 1: T₀-T₂ and Test Run 2: T₅-T₇).
- 6.1.11 Response Time: The Response Time of a Measured I/O Request is its Completion Time minus its Start Time.

- 6.1.12 **Start Time: Run-Out:** A specified, contiguous period of time in which the TSC is required to complete I/O Requests started but not completed during the preceding Measurement Interval. The Run- Out period begins at the end of the preceding Measurement Interval and is a component of the Steady State period (see Figure 6-1: Test Run 1: T₃-T₄ and Test Run 2: T₉-T₁₀). The Workload Generator will continue to submit I/O Requests at the Test Run's specified rate during the Run-Out period.
- 6.1.13 **Start Time:** The time recorded by the Workload Generator when an I/O Request is submitted for execution on the TSC.
- 6.1.14 **Steady State:** The period during which the workload presented to the TSC by the SPC-2 Workload Generator is constant and the resulting TSC I/O Request Throughput is both consistent and sustainable. The Steady State period includes both the Measurement Interval and Run-Out periods (see Figure 6-1; Test Run 1: T₁-T₄ and Test Run 2: T₆-T₉).
- Comment:** Steady Stated is achieved only after caches in the TSC have filled and as a result the I/O Request Throughput of the TSC has stabilized.*
- 6.1.15 **Stream:** A collection of Stream Segments that started within a Test Run.
- 6.1.16 **Stream Segment:** A sequentially organized pattern of I/O requests, which transfers a contiguous range of data.
- 6.1.17 **Test:** A collection of Test Phases and or Test Runs sharing a common objective.
- 6.1.18 **Test Phase:** A collection of one or more SPC-2 Test Runs sharing a common objective and intended to be run in a specific sequence.
- 6.1.19 **Test Run:** The execution of SPC-2 that produces specific SPC-2 test results. SPC-2 Test Runs have specified, measured Ramp-Up, Measurement Interval, Run-Out and Ramp-Down periods. Figure 6-1 illustrates the Ramp-Up, Steady State, Measurement Interval, Run-Out, and Ramp-Down components contained in two uninterrupted SPC-2 Test Runs (Test Run 1: T₀-T₅ and Test Run 2: T₅-T₁₀).
- 6.1.20 **Test Run Sequence:** A related sequence of Large File Processing (LFP) or Large Database Query (LDQ) Test Runs. Each Test Run Sequence will consist of five Test Runs, which vary the number of Streams as follows:
- Test Run 1: Maximum number of Streams, which is selected by the Test Sponsor
 - Test Run 2: 50% of the maximum number of Streams used in Test Run 1.
 - Test Run 3: 25% of the maximum number of Streams used in Test Run 1.
 - Test Run 4: 12.5% of the maximum number of Streams used in Test Run 1.
 - Test Run 5: 1 Stream.
- Each of the five Test Runs in a Test Run Sequence will share the same attributes with the exception of the number of Streams. For example:
- Large File Processing, Read, 1024 KiB Transfer Size: Maximum Streams
 - Large File Processing, Read, 1024 KiB Transfer Size: 50% of Maximum Streams
 - Large File Processing, Read, 1024 KiB Transfer Size: 25% of Maximum Streams
 - Large File Processing, Read, 1024 KiB Transfer Size: 12.5% of Maximum Streams
 - Large File Processing, Read, 1024 KiB Transfer Size: 1 Stream
- 6.1.21 **Transfer Size:** A workload parameter defined in Clause 3.4.6.

Figure 6-1: SPC-2 Test Run Components

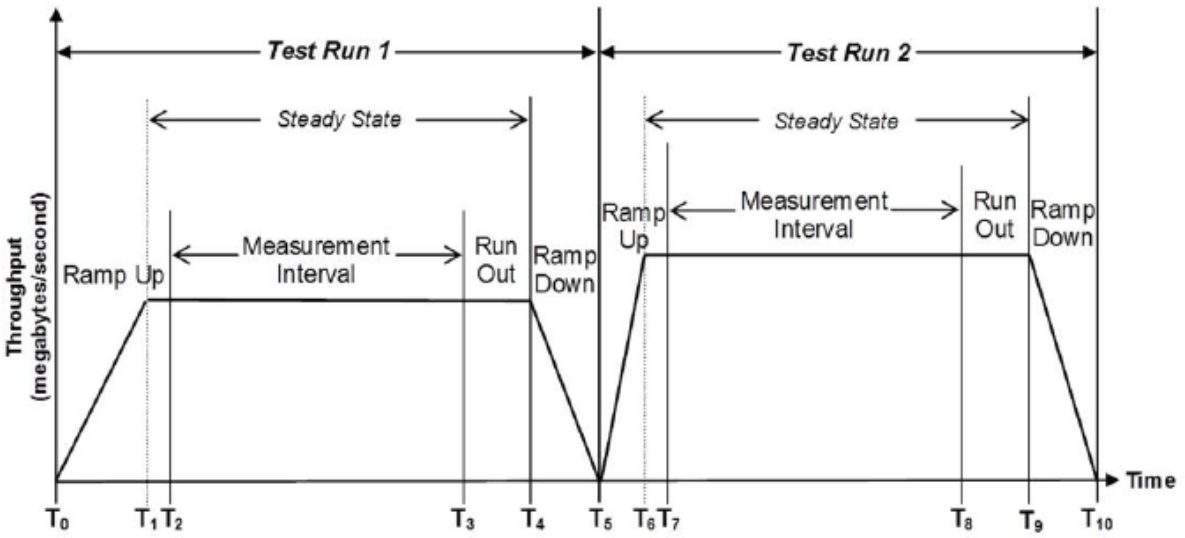
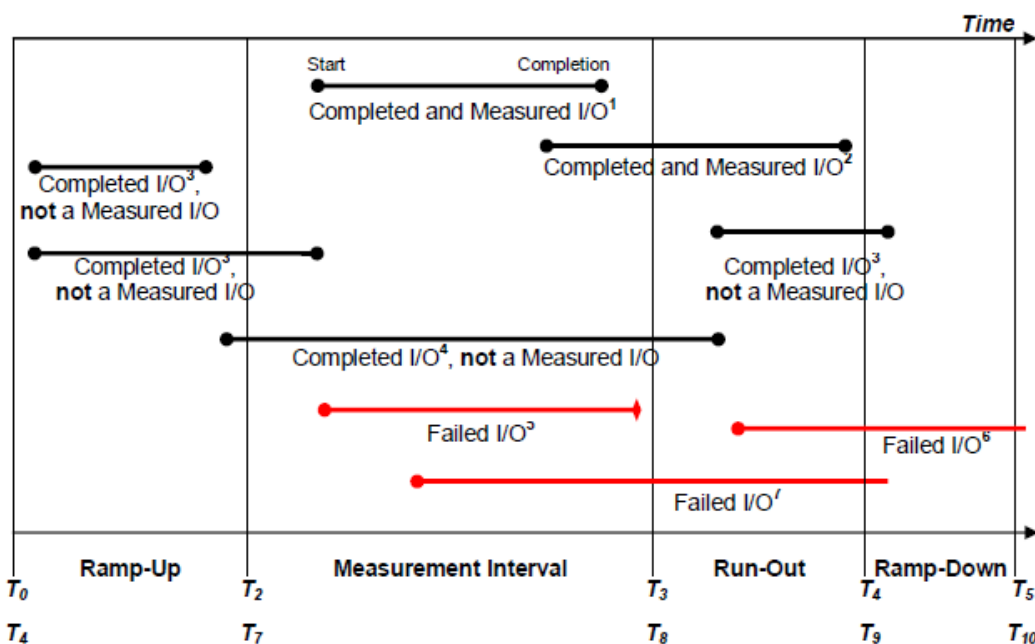

Figure 6-2: I/O Completion Types



Completed and Measured I/O¹: I/O started and completed within the Measurement Interval.

Completed and Measured I/O²: I/O started before the Measurement Interval and Completed within Ramp Down.

Completed I/O³: I/O started before or after the Measurement Interval – not measured.

Completed I/O⁴: I/O started before and completed after the Measurement Interval – not measured.

Failed I/O⁵: Signaled as failed by System Software.

Failed I/O⁶: I/O did not complete prior to the end of Ramp-Down.

Failed I/O⁷: I/O did not complete prior to the end of Run-Out.

6.2 Storage Capacities

The storage capacities, defined in Clause 4: Data Repository, are configured at the discretion of the Test Sponsor subject to the requirements of that clause.

6.3 Requirements and Constraints

6.3.1 SPC Approved Workload Generator

A SPC-2 result must be produced using the current, SPC-2-Workload Generator kit. The documentation included with the kit is to be considered an extension of this benchmark specification and will describe the appropriate use of the SPC-2 Workload Generator kit. The procedures, requirements, and constraints described in the kit documentation must be adhered to in order to produce a SPC-2 result. An overview of the SPC-2 Workload Generator may be found in Clause 5: SPC-2 Workload Generator.

6.3.2 Audit

A SPC-2 benchmark measurement must successfully complete an Audit as defined in Clause 10.6 before it can be submitted to the SPC and become a SPC-2 result.

6.3.3 ASU Pre-Fil

6.3.3.1 The SPC-2 ASU is required to be completely filled with specified content prior to execution of audited SPC-2 Tests. The content is required to consist of a random data pattern such as that produced by an SPC recommended tool.

6.3.3.2 If the Test Sponsor chooses to use a tool other than a SPC recommended tool, the Test Sponsor is required to provide adequate proof, to the Auditor satisfaction, that the resultant ASU content is equivalent to that produced by a SPC recommended tool as described above.

6.3.3.3 The required ASU pre-fill must be executed as the first step in the uninterrupted benchmark execution sequence described in Clause 6.4.2. That uninterrupted sequence will consist of: ASU Pre-Fill, Large File Processing, Large Database Query, Video on Demand Delivery and Persistence Test Run 1. The only exception to this requirement is described in Clause 6.3.4.

6.3.3.4 If approved by the Auditor, the Test Sponsor may complete the required ASU pre-fill prior to execution of the audited SPC-2 Tests and not as part of the audited SPC-2 Tests' execution sequence.

The Auditor will verify the required random data pattern content in the ASU prior to the execution of the audited SPC-2 Tests. If that verification fails, the Test Sponsor is required to reload the specified content to the ASU.

6.3.4 Benchmark Configuration (BC) Consistency

6.3.4.1 The physical and logical configuration of the BC shall not be changed across Tests, Test Phases or Test Runs.

6.3.4.2 Configuration and tuning parameters shall not be changed across Tests, Test Phases, or Test Runs with the exception of certain SPC-2 Workload Generator parameters as approved by the SPC Auditor.

6.3.5 Ramp-Up/Transition Period

The minimum Ramp-Up/Transition period for all SPC-2 Test Runs, unless otherwise specified, must be equal to or greater than three (3) minutes and ensure that the TSC has reached Steady State. The Start-Up periods, selected by the Test Sponsor, must be disclosed.

6.3.6 Measurement Resolution

The Measurement resolution for all reported Response Time results shall be 0.01 ms.

6.3.7 I/O Request Completion

All I/O Requests from one Test Run must complete before the Measurement Interval of the next Test Run can begin. All I/O Requests from one Test Run must complete before the Measurement Interval of the next Test Run can begin.

During the execution of each Test Run, all I/O Requests to read a block must be served by referencing the content of the block located on a configured Storage Device, or by providing a cached copy of the block that was previously staged from a configured Storage Device.

Comment: Specifically disallowed during the execution of each Test Run is any technique that causes a read I/O Request to respond as if the content of the referenced block is “initialized to zero” without actually obtaining the block image from a configured Storage Device. That may require formatting, pre-allocating, or pre-filling the configured Storage Device(s).

6.3.8 Failed I/O Requests

All I/O Requests initiated during any SPC-2 Test Run must complete. A Failed I/O Request shall result in an invalid SPC-2 test.

6.3.9 I/O Request Pre-generation

If the Workload Generator pre-generates I/O Requests to be issued to the TSC, the Test Sponsor shall not structure the execution or configuration of the BC to take advantage of the prior knowledge of the content of each pre-generated I/O request.

6.3.10 Data Persistence

Data persistence properties and requirements as specified in Clause 7 will be maintained for all I/O requests.

6.3.11 No Warm-up

Other than booting/starting the Host System(s), bringing ASU on-line for use by the Workload Generator, and starting the Workload Generator, no substantive work shall be performed on the BC prior to or in between SPC-2 Tests, Test Phases, or Test Runs.

Comment: It is the specific intent of this clause that Test Sponsors NOT be allowed to warm up caches or optimize automated tuning parameters between a Test, Test Phase, or Test Run

6.3.12 Interpolation or Rounding

Final reported metrics shall not be interpolated or averaged across Test Runs. Results shall not be rounded for computing results, reporting results, or making comparisons across between different results.

6.3.13 Adaptive Data Migration

Adaptive data migration will cause ASU data to be migrated to alternate storage locations for subsequent access during SPC-2 Test Runs.

6.3.13.1 Adaptive Data Migration Storage

The alternate storage locations, which are the destinations for migrated data, may be configured using any type of supported storage device, including a mixture of storage devices.

6.3.13.2 Adaptive Data Migration Requirements

- 6.3.13.2.1 The adaptive data migration can only occur during execution of the SPC-2 test sequence without any user/manual intervention.
- 6.3.13.2.2 Access to the migrated data, during the SPC-2 Test Runs, is transparent to the SPC-2 Workload Generator. The SPC-2 Workload Generator will always reference an ASU location and, when appropriate, the reference is transparently resolved to the location of the migrated data.
- 6.3.13.2.3 If the SPC-2 ASU is configured to exclude the storage which contains the alternate storage locations, that storage must be configured with data protection (Clause 2.7.2). The type of configured data protection for that storage need not be identical to the data protection specified for the storage that comprises the SPC-2 ASU.
- 6.3.13.2.4 If the SPC-2 ASU is configured to exclude the storage which contains the alternate storage locations, that total storage capacity (*available, protection and overhead*) will be included in the Required Storage portion of the Configured Storage Capacity (Clause 2.3.3).
- 6.3.13.2.5 If the SPC-2 ASU is configured to include the storage which contains the alternate storage locations, that storage will be included in the various storage capacity calculations (*Clauses 2.2– 2.6*) as appropriate.
- 6.3.13.2.6 All other SPC-2 Specification and SPC Policies requirements and constraints must be met.

6.4 SPC-2 Tests

6.4.1 An Overview of the SPC-2 Benchmark Tests

A SPC-2 benchmark measurement includes the following four Tests:

- The Large File Processing Test (Clause 6.4.3).
- The Large Database Query Test (Clause 6.4.3.5.1).
- The Video-On-Demand Delivery Test (Clause 6.4.5).
- The Data Persistence Test (Clause 7).

Each Test must be completed and reported for a SPC-2 benchmark result. Each Test will contain one or more Test Runs, each of which will generate required SPC-2 test results. The Test Runs within a Test may be organized into one or more Test Phases. Figure 6-3 and Figure 6-4 illustrates the flow of the SPC-2 Tests as well as the required sequence of Test Runs within a Test or Test Phase.

6.4.2 SPC-2 Benchmark Test Sequence

The Large File Processing, Large Database Query, and Video On Demand Delivery Test may be executed in any sequence. Once the sequence is selected, execution of the Test Runs within the sequence must be uninterrupted from the first Test Run of the first Test to the last Test Run of the last Test. In addition, Persistence Test Run 1 must follow the last Test Run of the selected sequence without interruption.

Uninterrupted means the Benchmark Configuration shall not be power cycled, restarted, disturbed, altered, or adjusted during the selected Test sequence. If the selected Test sequence is interrupted, the SPC-2 measurement is invalid. This does not apply to the interruption caused by the Host System/TSC power cycle between Persistence Test Run 1 and Persistence Test Run 2.

The Test Sponsor is not limited in the number of attempts to complete the selected, uninterrupted Test sequence.

An exception may be made by the auditor to the above requirement for an uninterrupted Test sequence. If such an exception is made, it will be documented in the "Audit Notes" portion of the SPC-2 Audit Certification Report.

Figure 6-3: Summary of SPC-2 Tests

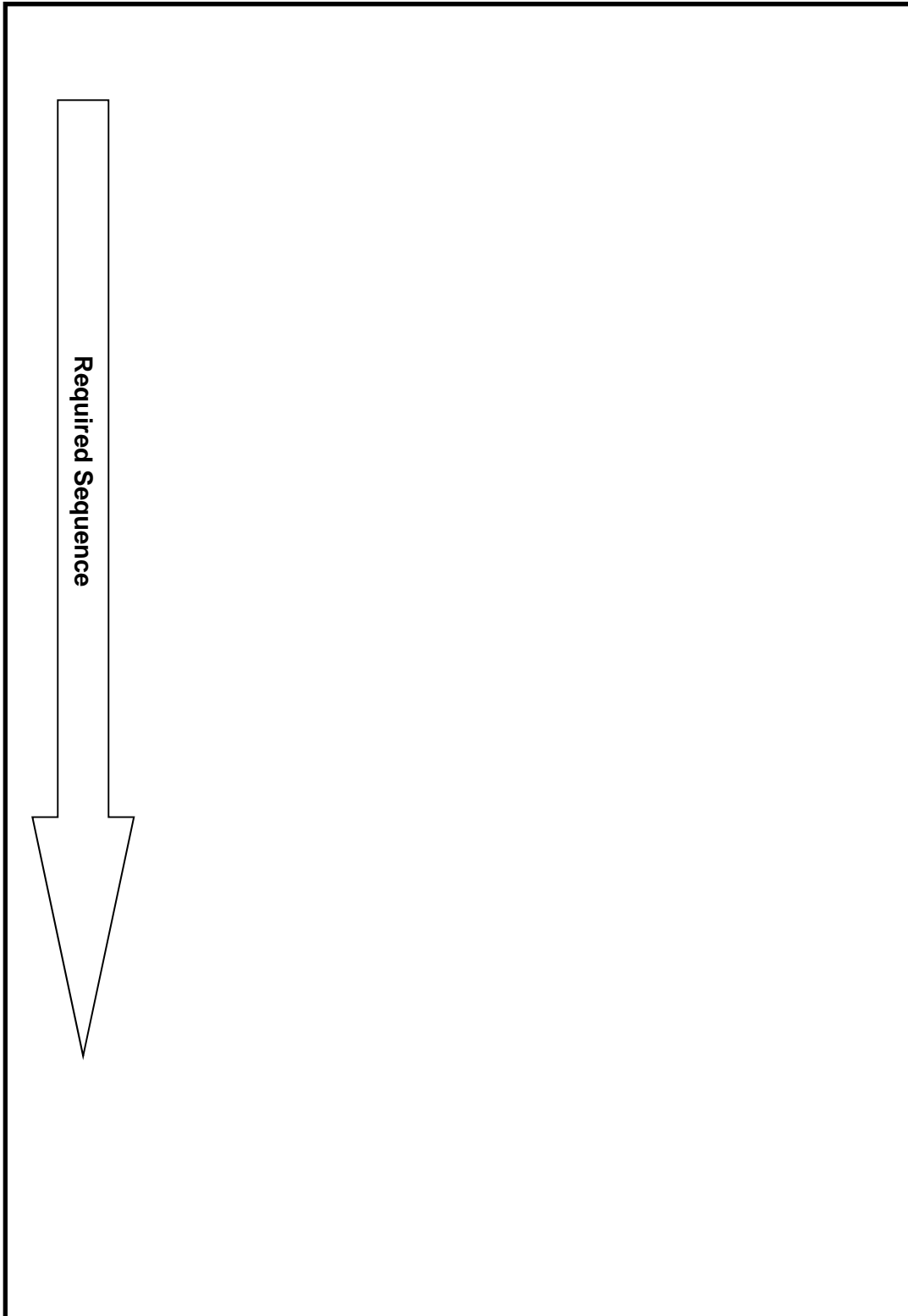
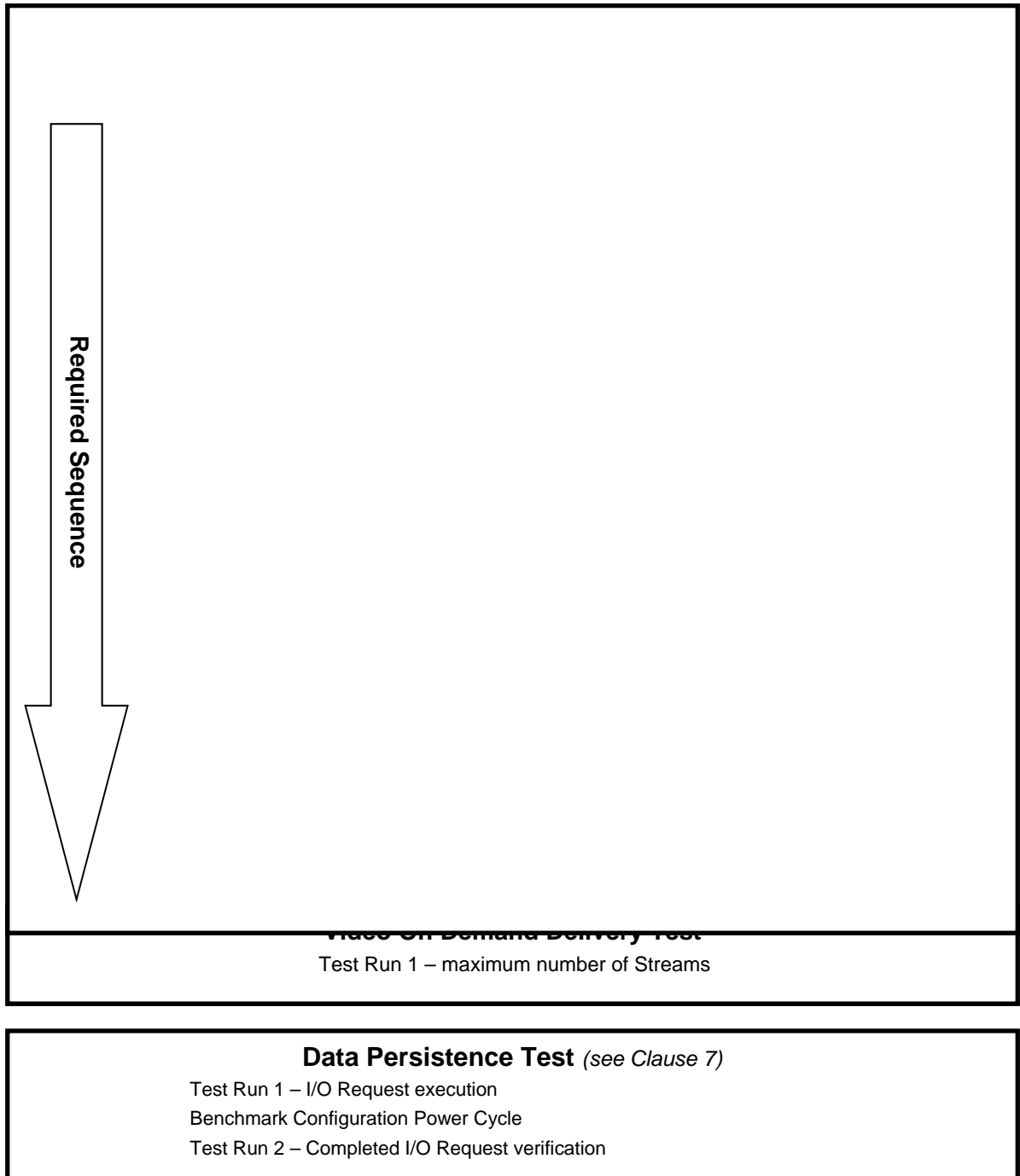

Figure 6-4: Summary of SPC-2 Tests (continued)



6.4.3 Large File Processing Test

6.4.3.1 Introduction

The Large File Processing Test consists of the I/O operations associated with the type of applications, in a wide range of fields, which require simple sequential processing of one or more large files. Specific examples of those types of applications include scientific computing and large-scale financial processing.

6.4.3.2 Overview

The Large File Processing Test has three Test Phases, which shall be executed in the following uninterrupted sequence:

1. WRITE ONLY
2. READ-WRITE
3. READ ONLY

The BC shall not be restarted or manually disturbed, altered, or adjusted during the execution of the Large File Processing Test. If power is lost to the BC during this Test all results shall be rendered invalid and the Test re-run in its entirety.

6.4.3.3 WRITE ONLY Test Phase

6.4.3.3.1 Figure 6-5 illustrates the components that comprise the WRITE ONLY Test Phase as well as the transition to the READ-WRITE Test Phase.

Figure 6-5: Large File Processing WRITE ONLY Test Phase

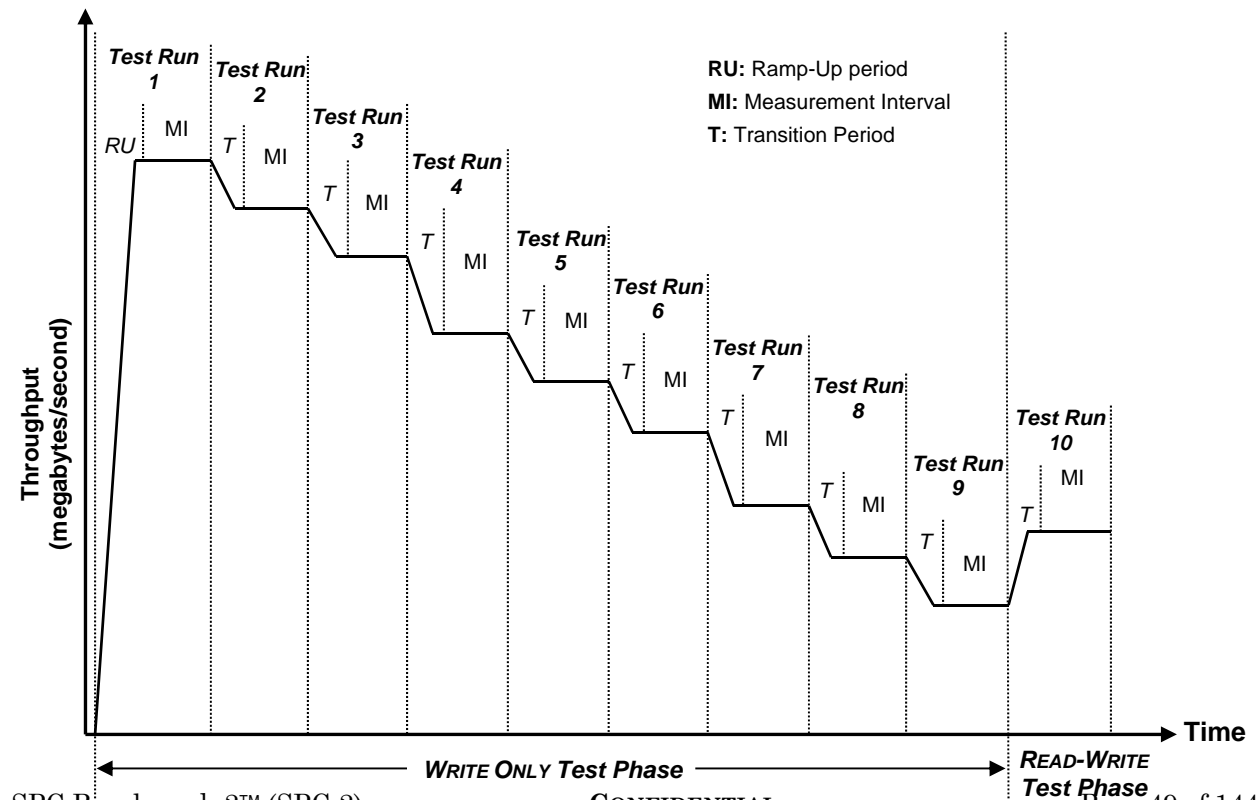

6.4.3.3.2 The Large File Processing WRITE ONLY Test Phase consists of the following two Test Run Sequences, which contain a total of ten (10) Test Runs:

- Test Run Sequence 1:
 - Test Run 1 – 1024 KiB Transfer – maximum number of Streams
 - Test Run 2 – 1024 KiB Transfer – 50% of Test Run 1’s Stream value
 - Test Run 3 – 1024 KiB Transfer – 25% of Test Run 1’s Stream value
 - Test Run 4 – 1024 KiB Transfer – 12.5% of the Test Run 1’s Stream value
 - Test Run 5 – 1024 KiB Transfer – single (1) Stream
- Test Run Sequence 2:
 - Test Run 6 – 256 KiB Transfer – maximum number of Streams
 - Test Run 7 – 256 KiB Transfer – 50% of Test Run 6’s Stream value
 - Test Run 8 – 256 KiB Transfer – 25% of Test Run 6’s Stream value
 - Test Run 9 – 256 KiB Transfer – 12.5% of Test Run 6’s Stream value

6.4.3.3.3 The value for “maximum number of Streams” is selected by the Test Sponsor with the only requirement that the selected value is greater than or equal to five (5). The “maximum number of Streams” value selected for a specific Test Run Sequence is not required to be identical to the value selected for any other Test Run Sequence.

6.4.3.3.4 The three “intermediate” Stream values for a Test Run Sequence are calculated using the percentages listed in Clause 6.4.3.3.2 if the value selected for the “maximum number of Streams” in the sequence is greater than fifteen (15). In those cases, the “intermediate” Stream values are calculated using integer (truncation) arithmetic.

If value selected for the “maximum number of Streams” in a Test Run Sequence is less than or equal to fifteen (15), the three “intermediate” Stream values for that sequence are determined by the values in the appropriate row of Table 6-1.

Table 6-1: Large File Processing (LFP) Required Stream Values

Test Run <i>Maximum</i>	Test Run <i>Intermediate</i>	Test Run <i>Intermediate</i>	Test Run <i>Intermediate</i>	Test Run <i>1 Stream</i>
15	7	3	2	1
14	7	3	2	1
13	6	3	2	1
12	6	3	2	1
11	5	3	2	1
10	5	3	2	1
9	4	3	2	1
8	4	3	2	1
7	4	3	2	1
6	4	3	2	1
5	4	3	2	1

6.4.3.3.5 The Test Runs will be executed in an uninterrupted sequence from Test Run 1 to Test Run 10.

6.4.3.3.6 Each Test Run will consist of a Ramp-Up period, a Measurement Interval, a Run-Out, and a Ramp-Down period.

6.4.3.3.7 The duration of the Ramp-Up period prior to each WRITE ONLY Test Run is selected by the Test Sponsor subject to the following requirements:

- The first Test Run in each Test Run Sequence (*Test Runs 1 and 6*) will use identical values for the duration of the Ramp-Up period. The selected value is required to be greater than or equal to three (3) minutes.
- The remaining Test Runs (*Test Runs 2-5 and Test Runs 7-10*) will use identical values for the Ramp-Up period. The selected value is required to be greater than or equal to three (3) minutes.

Ramp-Up duration values selected for the WRITE ONLY Test Phase are not required to be identical to the Ramp-Up duration values in any other Test Phase..

Comment: *The purpose of the Ramp-Up period is to ensure Steady State has been reached prior to the start of the Measurement Interval. If the minimum Ramp-Up duration is not sufficient to achieve Steady State the Measurement Interval cannot begin. In such a case, the Test Sponsor is required to select a Ramp-Up duration that is greater than the minimum in order to achieve Steady State.*

6.4.3.3.8 The duration of the Measurement Interval is set to three (3) minutes by the SPC-2 Workload Generator.

6.4.3.3.9 The duration of the Run-Out period is set to forty-five (45) seconds by the SPC-2 Workload Generator.

6.4.3.3.10 The duration of the Ramp Down period is set to fifteen (15) seconds by the SPC-2 Workload Generator.

6.4.3.3.11 The SPC-2 Workload Generator will set the Stream Segment size to 0.5 GiB (536,870,912 bytes) for each WRITE ONLY Test Run.

6.4.3.4 READ-WRITE Test Phase

6.4.3.4.1 Figure 6-6 illustrates the components that comprise the READ-WRITE Test Phase as well as the transition from the WRITE ONLY Test Phase and the transition to the READ ONLY Test Phase.

Figure 6-6: Large File Processing READ-WRITE Test Phase

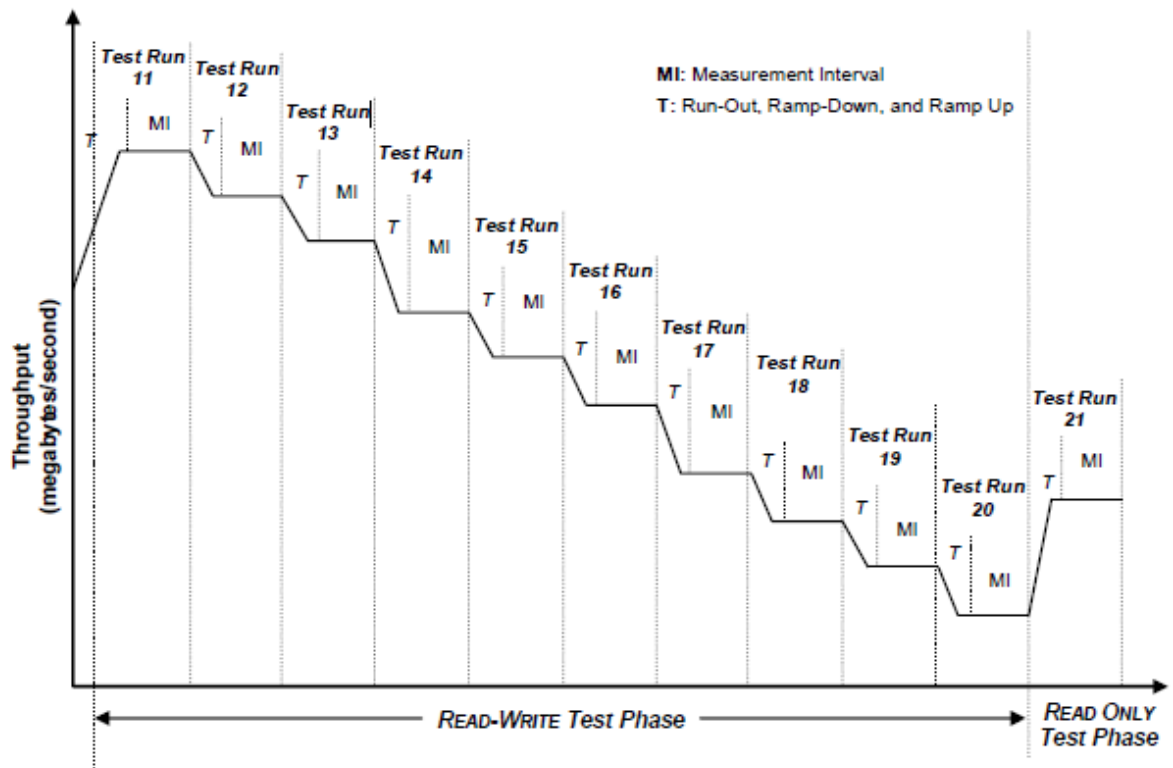

6.4.3.4.2 The Large File Processing READ-WRITE Test Phase immediately follows the Large File Processing WRITE ONLY Test Phase without any interruption.

6.4.3.4.3 The Large File Processing READ-WRITE Test Phase consists of the following two Test Run Sequences, which contain a total of ten (10) Test Runs:

- **Test Run Sequence 3:**
 - Test Run 11 – 1024 KiB Transfer – maximum number of Streams
 - Test Run 12 – 1024 KiB Transfer – 50% of Test Run 11’s Stream value
 - Test Run 13 – 1024 KiB Transfer – 25% of Test Run 11’s Stream value
 - Test Run 14 – 1024 KiB Transfer – 12.5% of the Test Run 11’s Stream value
 - Test Run 15 – 1024 KiB Transfer – single (1) Stream
- **Test Run Sequence 4:**
 - Test Run 16 – 256 KiB Transfer – maximum number of Streams
 - Test Run 17 – 256 KiB Transfer – 50% of Test Run 16’s Stream value
 - Test Run 18 – 256 KiB Transfer – 25% of Test Run 16’s Stream value

- Test Run 19 – 256 KiB Transfer – 12.5% of Test Run 16’s Stream value
- Test Run 20 – 256 KiB Transfer – single (1) Stream

6.4.3.4.4 The value for “maximum number of Streams” is selected by the Test Sponsor with the only requirement that the selected value is greater than or equal to five (5). The “maximum number of Streams” value selected for a specific Test Run Sequence is not required to be identical to the value selected for any other Test Run Sequence.

6.4.3.4.5 The three “intermediate” Stream values for a Test Run Sequence are calculated using the percentages listed in Clause 6.4.3.4.3 if the value selected for the “maximum number of Streams” in the sequence is greater than fifteen (15). In those cases, the “intermediate” Stream values are calculated using integer (truncation) arithmetic.

If value selected for the “maximum number of Streams” in a Test Run Sequence is less than or equal to fifteen (15), the three “intermediate” Stream values for that sequence are determined by the values in the appropriate row of Table 6-1.

6.4.3.4.6 The Test Runs will be executed in an uninterrupted sequence from Test Run 11 to Test Run 20.

6.4.3.4.7 Each Test Run will consist of a Ramp-Up period, a Measurement Interval, a Run-Out period, and a Ramp-Down period.

6.4.3.4.8 The duration of the Ramp-Up period prior to each READ-WRITE Test Run is selected by the Test Sponsor.

- The first Test Run in each Test Run Sequence (Test Runs 11 and 16) will use identical values for the duration of the Ramp-Up period. The selected value is required to be greater than or equal to three (3) minutes.
- The remaining Test Runs (Test Runs 12-15 and Test Runs 17-20) will use identical values for the Ramp-Up period. The selected value is required to be greater than or equal to three (3) minutes.

Ramp-Up duration values selected for the READ-WRITE Test Phase are not required to be identical to the Ramp-Up duration values in any other Test Phase.

Comment: *The purpose of the Ramp-Up period is to ensure Steady State has been reached prior to the start of the Measurement Interval. If the minimum Ramp-Up duration is not sufficient to achieve Steady State the Measurement Interval cannot begin. In such a case, the Test Sponsor may select a Ramp-Up duration that is greater than the minimum in order to achieve Steady State.*

6.4.3.4.9 The duration of the Measurement Interval is set to three (3) minutes by the SPC-2 Workload Generator.

6.4.3.4.10 The duration of the Run-Out period is set to forty-five (45) seconds by the SPC-2 Workload Generator.

6.4.3.4.11 The duration of the Ramp Down period is set to fifteen (15) seconds by the SPC-2 Workload Generator.

6.4.3.4.12 The SPC-2 Workload Generator will set the Stream Segment size to 0.5 GiB (536,870,912 bytes) for each READ-WRITE Test Run.

6.4.3.5 READ ONLY Test Phase

6.4.3.5.1 Figure 6-7 illustrates the components that comprise the READ ONLY Test Phase as well as the transition from the READ-WRITE Test Phase.

Figure 6-7: Large File Processing READ ONLY Test Phase

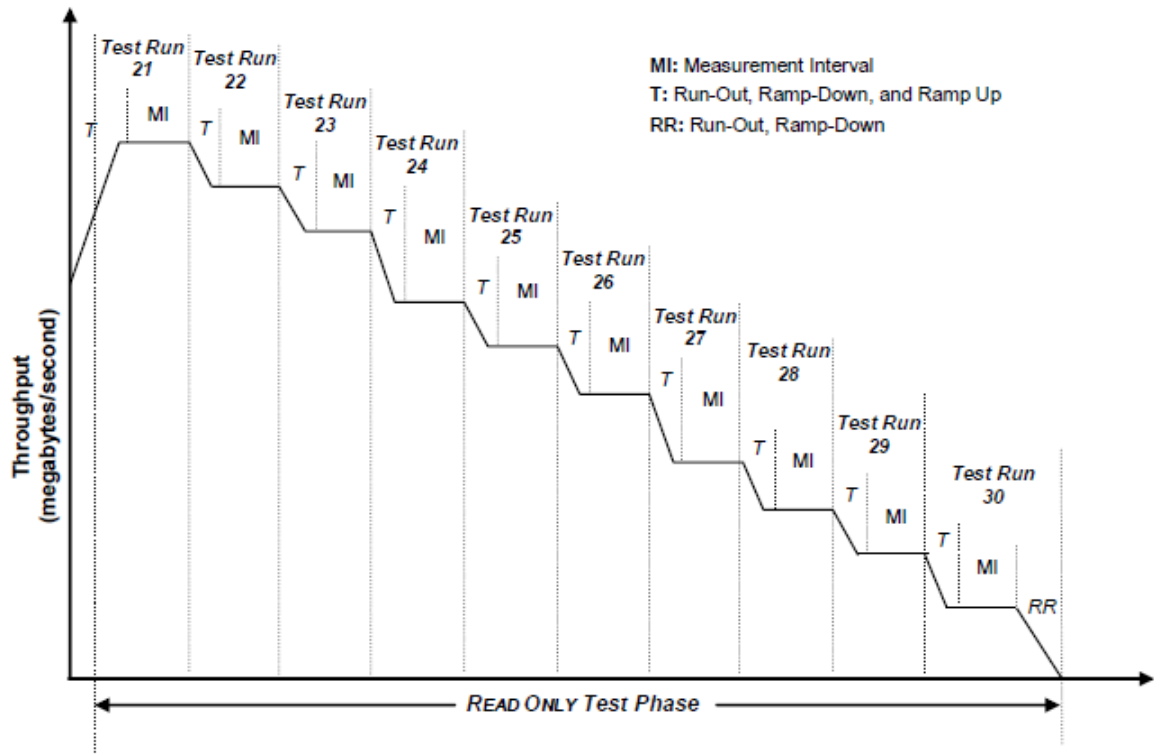

6.4.3.5.2 The Large File Processing READ ONLY Test Phase immediately follows the Large File Processing READ-WRITE Test Phase without any interruption.

6.4.3.5.3 Large File Processing READ ONLY Test Phase consists of the following two Test Run Sequences, which contain a total of ten (10) Test Runs:

- **Test Run Sequence 5:**
 - Test Run 21 – 1024 KiB Transfer – maximum number of Streams
 - Test Run 22 – 1024 KiB Transfer – 50% of Test Run 21’s Stream value
 - Test Run 23 – 1024 KiB Transfer – 25% of Test Run 21’s Stream value
 - Test Run 24 – 1024 KiB Transfer – 12.5% of the Test Run 21’s Stream value
 - Test Run 25 – 1024 KiB Transfer – single (1) Stream
- **Test Run Sequence 6:**
 - Test Run 26 – 256 KiB Transfer – maximum number of Streams
 - Test Run 27 – 256 KiB Transfer – 50% of Test Run 26’s Stream value
 - Test Run 28 – 256 KiB Transfer – 25% of Test Run 26’s Stream value

 - Test Run 29 – 256 KiB Transfer – 12.5% of Test Run 26’s Stream value

➤ Test Run 30 – 256 KiB Transfer – single (1) Stream

6.4.3.5.4 The value for “maximum number of Streams” is selected by the Test Sponsor with the only requirement that the selected value is greater than or equal to five (5). The “maximum number of Streams” value selected for a specific Test Run Sequence is not required to be identical to the value selected for any other Test Run Sequence.

6.4.3.5.5 The three “intermediate” Stream values for a Test Run Sequence are calculated using the percentages listed in Clause 6.4.3.5.3 if the value selected for the “maximum number of Streams” in the sequence is greater than fifteen (15). In those cases, the “intermediate” Stream values are calculated using integer (truncation) arithmetic.

If value selected for the “maximum number of Streams” in a Test Run Sequence is less than or equal to fifteen (15), the three “intermediate” Stream values for that sequence are determined by the values in the appropriate row of Table 6-1.

6.4.3.5.6 The Test Runs will be executed in an uninterrupted sequence from Test Run 21 to Test Run 30.

6.4.3.5.7 Each Test Run will consist of a Ramp-Up period, a Measurement Interval, a Run-Out period, and a Ramp-Down period.

6.4.3.5.8 The duration of the Ramp-Up period prior to each READ ONLY Test Run is selected by the Test Sponsor subject to the following requirements:

- The first Test Run in each Test Run Sequence (Test Runs 21 and 26) will use identical values for the duration of the Ramp-Up period. The selected value is required to be greater than or equal to three (3) minutes.
- The remaining Test Runs (Test Runs 22-25 and Test Runs 27-30) will use identical values for the Ramp-Up period. The selected value is required to be greater than or equal to three (3) minutes.

Ramp-Up duration values selected for the READ ONLY Test Phase are not required to be identical to the Ramp-Up duration values in any other Test Phase.

Comment: *The purpose of the Ramp-Up period is to ensure Steady State has been reached prior to the start of the Measurement Interval. If the minimum Ramp-Up duration is not sufficient to achieve Steady State the Measurement Interval cannot begin. In such a case, the Test Sponsor may select a Ramp-Up duration that is greater than the minimum in order to achieve Steady State.*

6.4.3.5.9 The duration of the Measurement Interval is set to three (3) minutes by the SPC-2 Workload Generator.

6.4.3.5.10 The duration of the Run-Out period is set to forty-five (45) seconds by the SPC-2 Workload Generator.

6.4.3.5.11 The duration of the Ramp Down period is set to fifteen (15) seconds by the SPC-2 Workload Generator.

6.4.3.5.12 The SPC-2 Workload Generator will set the Stream Segment size to 0.5 GiB (536,870,912 bytes) for each READ ONLY Test Run.

6.4.4 Large Database Query Test

6.4.4.1 Introduction

The Large Database Query Test is comprised of a set of I/O operations representative of scans or joins of large relational tables such as those performed for data mining or business intelligence.

6.4.4.2 Overview

The Large Database Query Test has two Test Phases, which shall be executed in the following sequence:

1. 1024 KiB TRANSFER SIZE
2. 64 KiB TRANSFER SIZE

The BC shall not be restarted or manually disturbed, altered, or adjusted during the execution of the Large Database Query Test. If power is lost to the BC during this Test all results shall be rendered invalid and the Test re-run in its entirety.

6.4.4.3 1024 KiB TRANSFER SIZE Test Phase

- 6.4.4.3.1 Figure 6-8 illustrates the components that comprise the 1024 KiB TRANSFER SIZE Test Phase and the transition to the 256 KiB TRANSFER SIZE Test Phase.

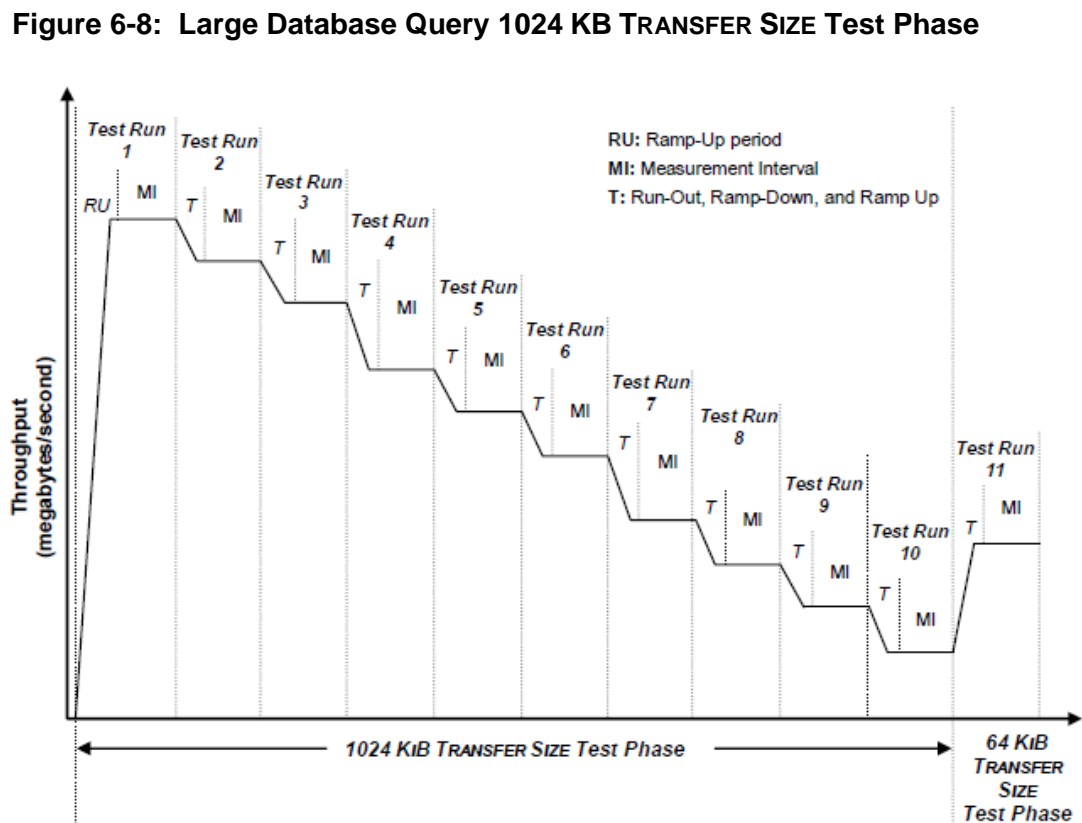

6.4.4.3.2 The Large Database Query 1024 KIB TRANSFER SIZE Test Phase consists of the following two Test Run Sequences, which contain a total of ten (10) Test Runs:

- **Test Run Sequence 1:**
 - Test Run 1 – 4 Outstanding I/O Requests – maximum number of Streams
 - Test Run 2 – 4 Outstanding I/O Requests – 50% of Test Run 1’s Stream value
 - Test Run 3 – 4 Outstanding I/O Requests – 25% of Test Run 1’s Stream value
 - Test Run 4 – 4 Outstanding I/O Requests – 12.5% of Test Run 1’s Stream value
 - Test Run 5 – 4 Outstanding I/O Requests – single (1) Stream
- **Test Run Sequence 2:**
 - Test Run 6 – 1 Outstanding I/O Request – maximum number of Streams
 - Test Run 7 – 1 Outstanding I/O Request – 50% of Test Run 6’s Stream value
 - Test Run 8 – 1 Outstanding I/O Request – 25% of Test Run 6’s Stream value
 - Test Run 9 – 1 Outstanding I/O Request – 12.5% of Test Run 6’s Stream value
 - Test Run 10 – 1 Outstanding I/O Request – single (1) Stream:

Comment: The “Outstanding I/O Requests” parameter represents a maximum value that the SPC-2 Workload Generator will attempt to maintain and ensure that it is not exceeded. See Clause 3.4.4 for a definition of the parameter.

6.4.4.3.3 The value for “maximum number of Streams” is selected by the Test Sponsor with the only requirement that the selected value is greater than or equal to five (5). The “maximum number of Streams” value selected for a specific Test Run Sequence is not required to be identical to the value selected for any other Test Run Sequence.

6.4.4.3.4 The three “intermediate” Stream values for a Test Run Sequence are calculated using the percentages listed in Clause 6.4.4.3.2 if the value selected for the “maximum number of Streams” in the sequence is greater than fifteen (15). In those cases, the “intermediate” Stream values are calculated using integer (truncation) arithmetic.

If value selected for the “maximum number of Streams” in a Test Run Sequence is less than or equal to fifteen (15), the three “intermediate” Stream values for that sequence are determined by the values in the appropriate row of Table 6-2.

Table 6-2: Large Database Query (LDQ) Required Stream Values

Test Run <i>Maximum</i>	Test Run <i>Intermediate</i>	Test Run <i>Intermediate</i>	Test Run <i>Intermediate</i>	Test Run <i>1 Stream</i>
15	7	3	2	1
14	7	3	2	1
13	6	3	2	1
12	6	3	2	1
11	5	3	2	1
10	5	3	2	1
9	4	3	2	1
8	4	3	2	1
7	4	3	2	1
6	4	3	2	1
5	4	3	2	1

- 6.4.4.3.5 The Test Runs will be executed in an uninterrupted sequence from Test Run 1 to Test Run 10.
- 6.4.4.3.6 Each Test Run will consist of a Ramp-Up period, a Measurement Interval, a Run-Out period, and a Ramp-Down period.
- 6.4.4.3.7 The duration of the Ramp-Up period prior to each 1024 KIB TRANSFER SIZE Test Run is selected by the Test Sponsor subject to the following requirements:
- The first Test Run in each Test Run Sequence (*Test Runs 1 and 6*) will use identical values for the duration of the Ramp-Up period. The selected value is required to be greater than or equal to three (3) minutes.
 - The remaining Test Runs (*Test Runs 2-5 and Test Runs 7-10*) will use identical values for the Ramp-Up period. The selected value is required to be greater than or equal to three (3) minutes.

Ramp-Up duration values selected for the 1024 KIB TRANSFER SIZE Test Phase are not required to be identical to the Ramp-Up duration values in any other Test Phase.

Comment: *The purpose of the Ramp-Up period is to ensure Steady State has been reached prior to the start of the Measurement Interval. If the minimum Ramp-Up duration is not sufficient to achieve Steady State the Measurement Interval cannot begin. In such a case, the Test Sponsor may select a Ramp-Up duration that is greater than the minimum in order to achieve Steady State.*

- 6.4.4.3.8 The duration of the Measurement Interval is set to three (3) minutes by the SPC-2 Workload Generator.
- 6.4.4.3.9 The duration of the Run-Out period is set to forty-five (45) seconds by the SPC-2 Workload Generator.
- 6.4.4.3.10 The duration of the Ramp Down period is set to fifteen (15) seconds by the SPC-2 Workload Generator.
- 6.4.4.3.11 The SPC-2 Workload Generator will set the Stream Segment size to 0.5 GiB (536,870,912 bytes) for each 1024 KIB TRANSFER SIZE Test Run.

6.4.4.4 64 KIB TRANSFER SIZE Test Phase

6.4.4.4.1 Figure 6-9 illustrates the components that comprise the 64 KIB TRANSFER SIZE Test Phase as well as the transition from the 1024 KIB TRANSFER SIZE Test Phase.

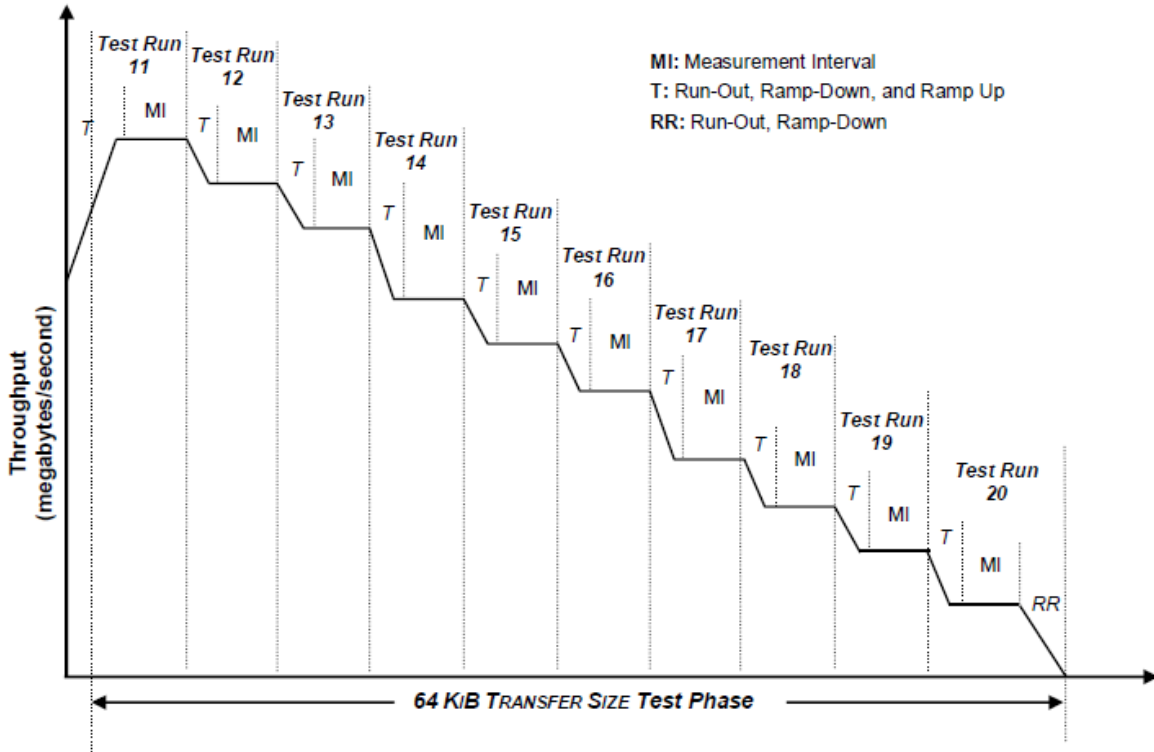

Figure 6-9: Large Database Query 64 KIB TRANSFER SIZE Test Phase

6.4.4.4.2 The Large Database Query 64 KIB TRANSFER SIZE Test Phase immediately follows the Large Database Query 1024 KIB TRANSFER SIZE Test Phase without any interruption.

6.4.4.4.3 The Large Database Query 64 KIB TRANSFER SIZE Test Phase consists of the following two Test Run Sequences, which contain a total of ten (10) Test Runs::

- **Test Run Sequence 3:**
 - Test Run 11 – 4 Outstanding I/O Requests – maximum number of Streams
 - Test Run 12 – 4 Outstanding I/O Requests – 50% of Test Run 11’s Stream value
 - Test Run 13 – 4 Outstanding I/O Requests – 25% of Test Run 11’s Stream value
 - Test Run 14 – 4 Outstanding I/O Requests – 12.5% of Test Run 11’s Stream value
 - Test Run 15 – 4 Outstanding I/O Requests – single (1) Stream
- **Test Run Sequence 4:**
 - Test Run 16 – 1 Outstanding I/O Request – maximum number of Streams
 - Test Run 17 – 1 Outstanding I/O Request – 50% of Test Run 16’s Stream value
 - Test Run 18 – 1 Outstanding I/O Request – 25% of Test Run 16’s Stream value
 - Test Run 19 – 1 Outstanding I/O Request – 12.5% of Test Run 16’s Stream

- Test Run 20 – 1 Outstanding I/O Request – single (1) Stream

Comment: *The “Outstanding I/O Requests” parameter represents a maximum value that the SPC-2 Workload Generator will attempt to maintain and ensure that it is not exceeded. See Clause 3.4.4 for a definition of the parameter.*

6.4.4.4.4 The value for “maximum number of Streams” is selected by the Test Sponsor with the only requirement that the selected value is greater than or equal to five (5). The “maximum number of Streams” value selected for a specific Test Run Sequence is not required to be identical to the value selected for any other Test Run Sequence.

6.4.4.4.5 The three “intermediate” Stream values for a Test Run Sequence are calculated using the percentages listed in Clause 6.4.4.4.3 if the value selected for the “maximum number of Streams” in the sequence is greater than fifteen (15). In those cases, the “intermediate” Stream values are calculated using integer (truncation) arithmetic.

If value selected for the “maximum number of Streams” in a Test Run Sequence is less than or equal to fifteen (15), the three “intermediate” Stream values for that sequence are determined by the values in the appropriate row of Table 6-2.

6.4.4.4.6 Each The Test Runs will be executed in an uninterrupted sequence from Test Run 11 to Test Run 20.

6.4.4.4.7 Each Test Run will consist of a Ramp-Up period, a Measurement Interval, a Run-Out period, and a Ramp-Down period.

6.4.4.4.8 The duration of the Ramp-Up period prior to each 64 KIB TRANSFER SIZE Test Run is selected by the Test Sponsor. Ramp-Up duration values selected for the 64 KIB TRANSFER SIZE Test Phase are not required to be identical to the Ramp-Up duration values in any other Test Phase.

- The first Test Run in each Test Run Sequence (Test Runs 11 and 16) will use identical values for the duration of the Ramp-Up period. The selected value is required to be greater than or equal to three (3) minutes.
- The remaining Test Runs (Test Runs 12-15 and Test Runs 17-20) will use identical values for the Ramp-Up period. The selected value is required to be greater than or equal to three (3) minutes.

The duration of the Ramp-Up period prior to Test Run 11 is required to be greater than or equal to ten (10) minutes. The remaining Ramp-Up periods (Test Runs 12-20) are required to be identical in duration that is greater than or equal to three (3) minutes.

Comment: *The purpose of the Ramp-Up period is to ensure Steady State has been reached prior to the start of the Measurement Interval. If the minimum Ramp-Up duration is not sufficient to achieve Steady State the Measurement Interval cannot begin. In such a case, the Test Sponsor may select a Ramp-Up duration that is greater than the minimum in order to achieve Steady State.*

6.4.4.4.9 The duration of the Measurement Interval is set to three (3) minutes by the SPC-2 Workload Generator.

6.4.4.4.10 The duration of the Run-Out period is set to forty-five (45) seconds by the SPC-2 Workload Generator.

6.4.4.4.11 The duration of the Ramp-Down period is set to fifteen (15) seconds by the SPC-2 Workload Generator.

The SPC-2 Workload Generator will set the Stream Segment size to 0.5 GiB (536,870,912 bytes) for each 64 KIB TRANSFER SIZE Test Run.

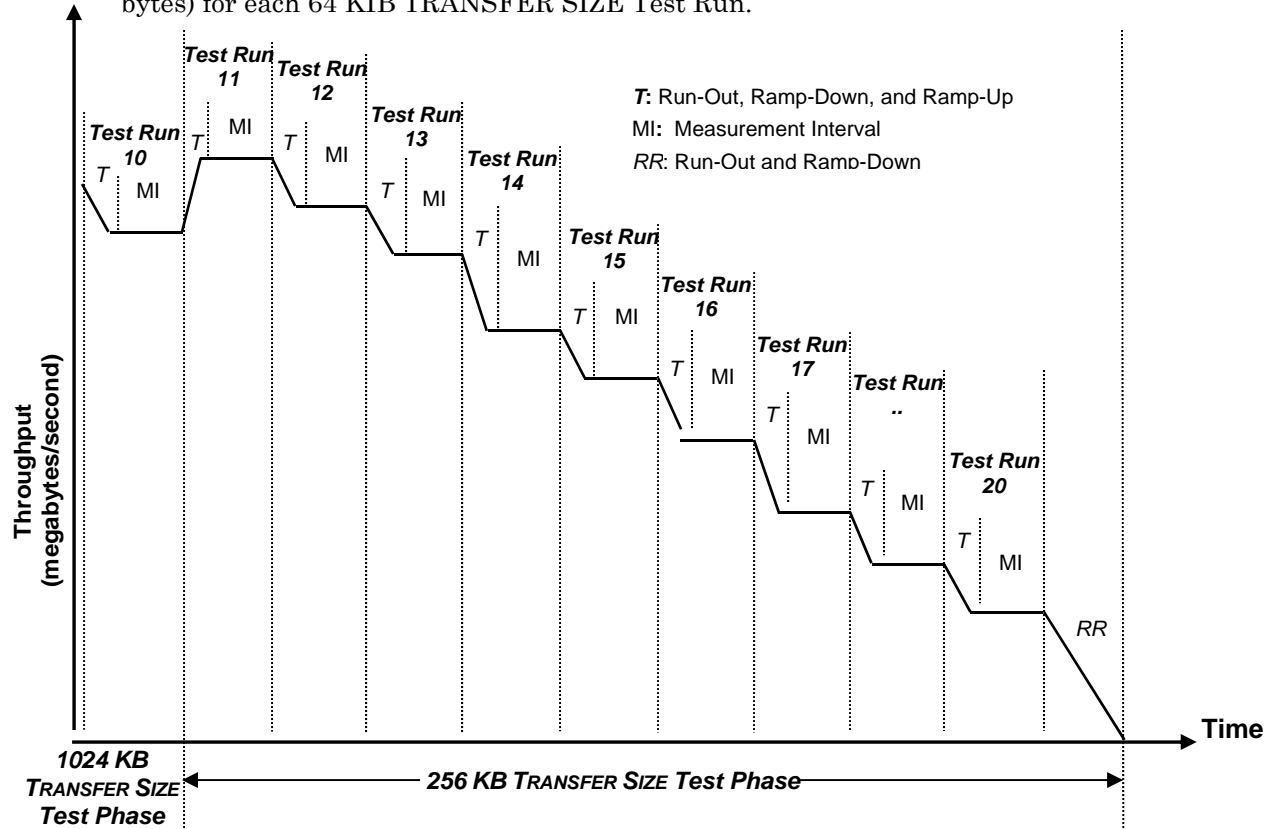

6.4.5 Video On Demand Delivery Test

6.4.5.1 Introduction

The Video On Demand Delivery Test represents the I/O operations required to enable individualized video entertainment for a community of subscribers, which draw from a digital film library.

6.4.5.2 Overview

- The Video On Demand Delivery Test consists of one (1) Test Run.

The Benchmark Configuration (BC) shall not be restarted or manually disturbed, altered, or adjusted during the execution of the Video On Demand Delivery Test. If power is lost to the BC during this Test all results shall be rendered invalid and the Test re-run in its entirety.

Figure 6-10 illustrates the components that comprise the Video On Demand Delivery Test.

Figure 6-10: Video On Demand Delivery Test

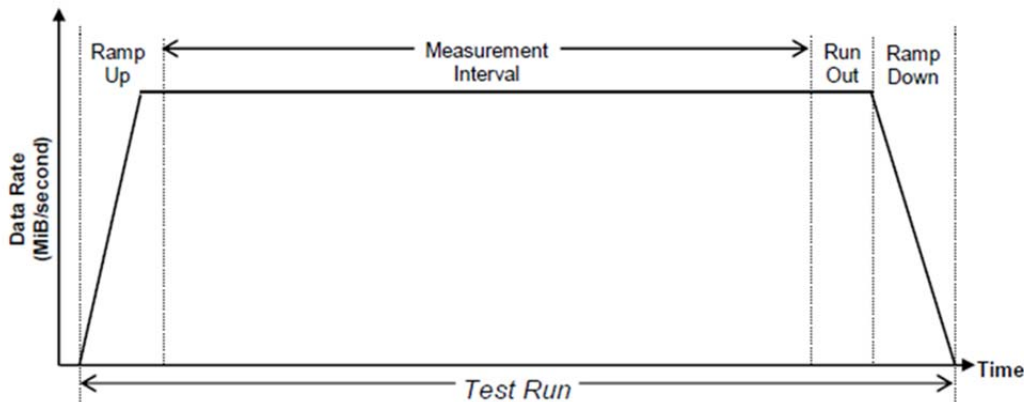

6.4.5.3 Video On Demand Delivery Test Runs

- 6.4.5.3.1 The value for “maximum number of Streams” is selected by the Test Sponsor.
- 6.4.5.3.2 The Test Run must ensure that all “consumer” requests for I/O are satisfied. If the SPC-2 Workload Generator reports such a request was not satisfied, the Test Run is invalid.
- 6.4.5.3.3 The Test Run will consist of a Ramp-Up period, a Measurement Interval, a Run-Out period, and a Ramp Down period.
- 6.4.5.3.4 The duration of the Ramp-Up period for the Video On Demand Delivery Test Run is set at a minimum of twenty (20) minutes by the SPC-2 Workload Generator.
Comment: The purpose of Ramp-Up period is to ensure Steady State has been reached prior to the start of the Measurement Interval.
- 6.4.5.3.5 The Measurement Interval duration for the Video On Demand Delivery Test Run is set at 120 minutes (2 hours) by the SPC-2 Workload Generator.
- 6.4.5.3.6 The duration of the Run-Out period is set to forty-five (45) seconds by the SPC-2 Workload Generator.

- 6.4.5.3.7 The duration of the Ramp-Down period is set to fifteen (15) seconds by the SPC-2 Workload Generator.
- 6.4.5.3.8 The SPC-2 Workload Generator will set the duration of each Stream Segment to twenty (20) minutes.

Clause 7: Data Persistence Requirements and Test

7.1 Introduction

Logical Volumes and related the Application Storage Unit (ASU) must demonstrate the ability to preserve data across extended periods of power loss without corruption or loss. To provide this “Persistence” capability, the Tested Storage Configuration (TSC) must use Logical Volumes and related ASU that:

- Are capable of maintaining data integrity across power cycles or outages.
- Ensure the transfer of data between Logical Volumes and host systems occurs without corruption or loss.

Data persistence does not guarantee data availability. Data loss may result from system component failure or unplanned catastrophe. The storage subsystem may, but need not, include mechanisms to protect against such failure modes. Testing or guaranteeing such failure modes and increased availability mechanisms in the test storage configuration are not within the mandate or the scope of this benchmark.

7.2 Persistence Test Validation

Validation that the SPC-2 Persistence Test completed successfully is provided by the SPC Audit Service, attesting to the fact that the test has been satisfactorily completed on the BC per the test requirements below.

7.3 SPC-2 Persistence Test Constraints

- 7.3.1 The SPC-2 Persistence Test consists of two Test Runs that are performed by the SPC-2 Workload Generator in isolation from other SPC-2 Tests.
- 7.3.2 The number of Streams specified for both Persistence Test Runs must be equal to the maximum number of Streams specified for the Large File Processing (LFP), Write Only Test Phase Test Runs (Test Runs 1-10).
- 7.3.3 The first Persistence Test Run will consist of a Ramp-Up period and Measurement Interval. The Ramp-Up period will be a minimum of three (3) minutes in duration, during which the specified number of Streams will be activated. The Measurement Interval will be five (5) minutes in duration, during which the specified number of Streams will be active concurrently. If the specified number of Streams are not active at the beginning of the Measurement Interval, the first Persistence Test will be considered invalid.
- 7.3.4 Any TSC that fails a Persistence Test can be rerun until it passes.
- 7.3.5 Success or failure of the Persistence Test shall be determined solely by information obtained from an SPC-2 Workload Generator Results File.
- 7.3.6 All I/O Requests initiated during any part of the Persistence Test in the SPC-2 benchmark must complete. A Failed I/O Request shall render a Persistence Test invalid.
- 7.3.7 No other work shall be performed on the BC during the execution of the Persistence Test Procedure.

7.4 Data Persistence Test Procedure

The following sequence of steps must be followed to complete the Persistence Test.

1. Execute Persistence Execute Persistence Test Run 1, which will consist of the SPC-2 Workload Generator writing a specific pattern at randomly selected locations throughout the Total ASU Capacity. The SPC-2 Workload Generator will retain the information necessary to later validate the pattern written at each location.
2. Shutdown and power off the Tested Storage Configuration (TSC). Any TSC caches employing battery backup must be flushed/emptied.
3. If the TSC includes the Host System(s), shutdown and power off the Host System(s). Any TSC caches on the Host System(s) employing battery backup must be flushed/emptied. If the TSC does not include the Host System(s), there is no requirement for the Host System configuration to be shutdown and power cycled.
4. Restart the TSC, and if the Host System(s) were shutdown and powered off, restart the Host System(s).
5. Execute Persistence Test Run 2, which will utilize the retained data from Persistence Test Run 1 to verify the bit patterns written in Persistence Test Run 1 and their corresponding location.
6. If the results of Persistence Test Run 2 verifies the bit patterns are correct and at the proper location, the Persistence Test completes successfully. If Persistence Test Run 2 reports any verification error, the Persistence Test fails.
7. The Workload Generator produces a Persistence Test Results File for each run of the Persistence Test. The format and distribution medium for these Results Files shall be determined by the SPC Audit Service. A copy of the Persistence Test Results File will be produced in a human-readable format.

Clause 8: Reported Metrics

8.1 SPC-2 Reported Data

SPC-2 Reported Data consists of two groups of information:

- SPC-2 Primary Metrics plus associated data, which characterizes the overall benchmark result.
- Reported data for each SPC Test: Large File Processing (LFP), Large Database Query (LDQ), and Video On Demand (VOD).

8.2 SPC-2 Price-Performance

The SPC-2 Primary Metrics consist of a data rate, price-performance, and storage capacity metric. The additional data associated with the SPC-2 Primary Metrics include the level of data protection used in the benchmark, total price of the storage configuration, formal name of the currency used in pricing, “target country” and SPC-2 Audit Identifier.

8.2.1 SPC-2 MBPS™ (*Data Rate*)

8.2.1.1 The SPC-2 MBPS™ metric is defined as the arithmetic mean of the following data rate values:

- SPC-2 (LFP) Data Rate as defined in Clause 8.5.2.1.1.
- SPC-2 (LDQ) Data Rate as defined in Clause 8.5.4.1.1.
- SPC-2 (VOD) Data Rate as defined in Clause 8.5.5.1.1.

8.2.1.2 All public references to this data rate metric must be labeled as “SPC-2 MBPS™”.

8.2.2 SPC-2 Price-Performance™

8.2.2.1 SPC-2 Price-Performance is defined as the ratio of the Total System Price, as defined in Calculation of Priced Storage Configuration Pricing Clause 9.1.6, to the SPC-2 MBPS™.

8.2.2.2 SPC-2 Price-Performance must be reported to a resolution of the smallest negotiable whole unit of the pricing currency in which Total System Price is reported, per Clause 9.2.4. For example, configurations priced in US dollars would report SPC-2 Price-Performance to a resolution of \$0.01.

8.2.2.3 All public references to this price-performance metric must be labeled as “SPC-2 Price-Performance of xxx” with the appropriate currency symbol for local pricing.

8.2.3 Total Application Storage Unit (ASU) Capacity

8.2.3.1 Total ASU Capacity is defined in Clauses 2.6.5 and 2.6.6.

8.2.3.2 All public references to the ASU Total Capacity primary metric must be labeled as “Capacity of xxx GB”.

8.3 SPC-2 Associated Data

SPC-2 Associated Data consists of the following:

- Data Protection Level used in the benchmark measurement (*Clause 2.7.2*)
- Total price of the Priced Storage Configuration (*Clause 9.3.1.4*)
- Formal name of the currency used in the Priced Storage Configuration pricing.

- Target Country” if a non-local currency is used in the Priced Storage Configuration pricing (*Clause 9.2.3*).
- SPC-2 Submission Identifier (*Clause 11.4.8*)

8.4 SPC-2 Primary Metrics – Public Use Requirements

Section 11.2.1 of the SPC Policies and Guidelines defines the requirements for public use of SPC Results. The following clauses present public use requirements in the context of SPC-2 Results. Section 11.2.1 of the SPC Policies and Guidelines should be reviewed in its entirety to ensure compliance with the complete set of requirements.

8.4.1 Referencing Non-Local Currency Reported Data

A public reference, which includes SPC-2 Price-Performance and/or SPC-2 Total Price, for an SPC-2 Result that uses non-local currency pricing (*Clause 9.2.4.2*) must include a clear statement of the currency used and the “target country” (*Clause 9.2.3*). For example, “SPC-2 Pricing is in U.S. dollars for product availability, sales, and support in People’s Republic of China”.

8.4.2 Referencing a Single SPC-2 Result

8.4.2.1 A public reference to an SPC-2 Result is required include one of the following:

1. A complete URL (hyperlink) to the SPC-2 Result’s entry on the “SPC-2 Results” page of the SPC website.
2. The complete set of SPC-2 Reported Data, which consists of SPC-2 MBPS™, SPC-2 Price-Performance™, Total ASU Capacity, Priced Storage Configuration total price, formal currency name used in pricing, “target country”, data protection level, and SPC-2 Audit Identifier. This set of information must use the same font style, font size, and text clarity for item in the set. The set of information may appear as a text paragraph or table of information.

In either case, the public reference must include the “current as of” date.

8.4.2.2 Any of the SPC-2 Reported Data may be used in a public reference without stating the complete set of SPC-2 Reported Data as long as the following requirements are met:

1. The URL defined in Clause 8.4.2.1 is included in the public reference.
2. The public reference includes the “current as of” date.

8.4.3 Referencing Two or More SPC-2 Results

8.4.3.1 If a public reference of two or more SPC-2 Results does not include any comparison of SPC-2 Reported Data, the requirements in Clauses 8.4.2.1 and 8.4.2.2 are applicable.

8.4.4 Comparing Two or More SPC-2 Results

SPC-2 Reported Data may be used in public reference to compare two or more SPC-2 results under the following conditions:

1. In addition to the SPC-2 Reported Data used in the comparison, each referenced SPC-2 Result must include either the complete set of SPC-2 Reported Data or the URL defined in Clause 8.4.2.1.

2. If the complete set of SPC-2 Reported Data is included for one of the referenced SPC-2 Results, the complete set of SPC-2 Reported Data must be included for all of the referenced results.
3. If the public reference consists of printed or displayed materials, the required items in #1 and #2 for each SPC-2 Result must use the same font style, font size, and text clarity. The set of information may appear as a text paragraph or table of information.
4. The pricing currency and “target country” must both be identical when a comparison includes SPC-2 Price-Performance and/or SPC-2 Total Price.
5. The public reference must include the “current as of” date.

8.5 SPC-2 Test-Specific Reported Data

The Large File Processing and Large Database Query Tests provide reported data for each of their Test Run Sequences as well as a set of composite data, which represents the overall performance for each Test. The Video On Demand Test provides reported data from its single Test Run.

8.5.1 Large File Processing (LFP) Test Run Sequence Data

The LFP Test Run Sequence data consists of the data rate, the related stream value, and a calculated data rate per stream value reported in the Executive Summary (Table 10-10) for each of the following Test Run Sequences:

- LFP Test Sequence 1: WRITE ONLY, 1024 KiB Transfer Size
- LFP Test Sequence 2: WRITE ONLY, 256 KiB Transfer Size
- LFP Test Sequence 3: READ-WRITE, 1024 KiB Transfer Size
- LFP Test Sequence 4: READ-WRITE, 256 KiB Transfer Size
- LFP Test Sequence 5: READ ONLY, 1024 KiB Transfer Size
- LFP Test Sequence 6: READ ONLY, 256 KiB Transfer Size

8.5.1.1 LFP Test Run Sequence Data Annotation

All LFP Test Run Sequence data must be labeled with the appropriate LFP Test Run Sequence annotation from the following list:

- LFP, Write, 1024 KiB
- LFP, Write, 256 KiB
- LFP, Read-Write, 1024 KiB
- LFP, Read-Write, 256 KiB
- LFP, Read, 1024 KiB
- LFP, Read, 256 KiB

8.5.1.2 LFP Test Run Sequence: Data Rate

8.5.1.2.1 The data rate reported for each LFP Test Run Sequence is selected by the Test Sponsor from the Test Runs that comprise the LFP Test Run Sequence (Clauses 6.4.3.3.2, 6.4.3.4.3, and 6.4.3.5.3).

8.5.1.2.2 All public references to the data rate reported for each LFP Test Run Sequence must be labeled as SPC-2 (*annotation*) Data Rate, using the appropriate LFP annotation (Clause 8.5.1.1).

8.5.1.3 LFP Test Run Sequence: Number of Streams

8.5.1.3.1 The number of Streams reported for each LFP Test Run Sequence is the number of Streams used to generate the reported LFP Test Run Sequence Data Rate.

8.5.1.3.2 All public references to the number of Streams reported for each LFP Test Run Sequence must be labeled as SPC-2 (annotation) Number of Streams, using the appropriate LFP annotation (Clause 8.5.1.1).

8.5.1.4 LFP Test Run Sequence: Data Rate per Stream

8.5.1.4.1 The data rate per Stream value reported for each LFP Test Run Sequence is the ratio of SPC-2 (annotation) Data Rate to SPC-2 (annotation) Number of Streams.

8.5.1.4.2 All public references to the data rate per Stream reported for each LFP Test Run Sequence must be labeled as SPC-2 (annotation) Data Rate per Stream, using the appropriate LFP annotation (Clause 8.5.1.1).

8.5.2 Large File Processing (LFP) Composite Data

The LFP composite data consists of LFP-specific data rate and price-performance values.

8.5.2.1 SPC-2 (LFP) Data Rate

8.5.2.1.1 SPC-2 (LFP) Data Rate is defined as the arithmetic mean of the data rate values reported in Executive Summary (see Table 10-x) for the following six LFP Test Run Sequences:

- LFP Test Sequence 1: WRITE ONLY, 1024 KiB Transfer Size
- LFP Test Sequence 2: WRITE ONLY, 256 KiB Transfer Size
- LFP Test Sequence 3: READ-WRITE, 1024 KiB Transfer Size
- LFP Test Sequence 4: READ-WRITE, 256 KiB Transfer Size
- LFP Test Sequence 5: READ ONLY, 1024 KiB Transfer Size
- LFP Test Sequence 6: READ ONLY, 256 KiB Transfer Size

8.5.2.1.2 All public references to this composite data rate value must be labeled as “SPC-2 (LFP) Data Rate”.

8.5.2.2 SPC-2 (LFP) Price-Performance

8.5.2.2.1 SPC-2 (LFP) Price-Performance is defined as the ratio of the Total System Price, as defined in Clause 9.1.6, to SPC-2 (LFP) Data Rate.

8.5.2.2.2 All public references to this composite price-performance value must be labeled as “SPC-2 (LFP) Price-Performance”.

8.5.3 Large Database Query (LDQ) Test Run Sequence Data

The LDQ Test Run Sequence data consists of the data rate, the related stream value, and a calculated data rate per stream value reported in the Executive Summary (Table 10-10) for each of the following Test Run Sequences:

- LDQ Test Sequence 1: 1024 KIB TRANSFER SIZE, 4 Outstanding I/Os
- LDQ Test Sequence 2: 1024 KIB TRANSFER SIZE, 1 Outstanding I/O
- LDQ Test Sequence 3: 64 KIB TRANSFER SIZE, 4 Outstanding I/Os
- LDQ Test Sequence 4: 64 KIB TRANSFER SIZE, 1 Outstanding I/O

8.5.3.1 LDQ Test Run Sequence Data Annotation

All LDQ Test Run Sequence data must be labeled with the appropriate Test Run Sequence annotation from the following list:

- LDQ, 1024 KiB, 4 I/Os
- LDQ, 1024 KiB, 1 I/O
- LDQ, 64 KiB, 4 I/Os
- LDQ, 64 KiB, 1 I/O

8.5.3.2 LDQ Test Run Sequence: Data Rate

8.5.3.2.1 The data rate reported for each LDQ Test Run Sequence is selected by the Test Sponsor from the Test Runs that comprise the LDQ Test Run Sequence (Clauses 6.4.4.3.2 and 6.4.4.4.3).

8.5.3.2.2 All public references to the data rate reported for each LDQ Test Run Sequence must be labeled as SPC-2 (annotation) Data Rate, using the appropriate LDQ annotation (Clause 8.4.3.1).

8.5.3.3 LDQ Test Run Sequence: Number of Streams

8.5.3.3.1 The number of Streams reported for each LDQ Test Run Sequence is the number of Streams used to generate the reported LDQ Test Run Sequence Data Rate.

8.5.3.3.2 All public references to the number of Streams reported for each LDQ Test Run Sequence must be labeled as SPC-2 (annotation) Number of Streams, using the appropriate LDQ annotation (Clause 8.4.3.1).

8.5.3.4 LDQ Test Run Sequence: Data Rate per Stream

8.5.3.4.1 The data rate per Stream value reported for each LDQ Test Run Sequence is the ratio of SPC-2 (annotation) Data Rate to SPC-2 (annotation) Number of Streams.

8.5.3.4.2 All public references to the data rate per Stream reported for each LDQ Test Run Sequence must be labeled as SPC-2 (annotation) Data Rate per Stream, using the appropriate LDQ annotation (Clause 8.4.3.1).

8.5.4 Large Database Query (LDQ) Composite Data

The LDQ composite data consists of LDQ-specific data rate and price-performance values.

8.5.4.1 SPC-2 (LDQ) Data Rate

8.5.4.1.1 SPC-2 (LDQ) Data Rate is defined as the arithmetic mean of the data rate values reported in Executive Summary (see Table 10-x) for the following four LDQ Test Run Sequences:

- LFP Test Sequence 1: 1024 KIB TRANSFER SIZE, 4 Outstanding I/Os
- LFP Test Sequence 2: 1024 KIB TRANSFER SIZE, 1 Outstanding I/Os
- LFP Test Sequence 3: 64 KIB TRANSFER SIZE, 4 Outstanding I/Os
- LFP Test Sequence 4: 64 KIB TRANSFER SIZE, 1 Outstanding I/Os

8.5.4.1.2 All public references to this composite data rate value must be labeled as “SPC-2 (LDQ) Data Rate”.

8.5.4.2 SPC-2 (LDQ) Price-Performance

8.5.4.2.1 SPC-2 (LDQ) Price-Performance is defined as the ratio of the Total System Price, as defined in Clause 9.1.6, to SPC-2 (LDQ) Data Rate.

8.5.4.2.2 All public references to this composite price-performance value must be labeled as “SPC-2 (LDQ) Price-Performance”.

8.5.5 Video On Demand (VOD) Test Data

The VOD test data consists of a data rate value reported by the single VOD Test Run, the number of Streams specified to obtain that data rate, the average data rate per stream, and a VOD-specific price-performance value.

8.5.5.1 SPC-2 (VOD) Data Rate

8.5.5.1.1 SPC-2 (VOD) Data Rate is the average data rate obtained during the Measurement Interval of the single VOD Test Run.

8.5.5.1.2 All public references to this reported data rate value must be labeled as “SPC-2 (VOD) Data Rate”.

8.5.5.2 SPC-2 (VOD) Number of Streams

8.5.5.2.1 SPC-2 (VOD) Number of Streams is number of Streams specified to generate the reported SPC-2 (VOD) Data Rate.

8.5.5.2.2 All public references to this value must be labeled as “SPC-2 (VOD) Number of Streams”.

8.5.5.3 SPC-2 (VOD) Data Rate per Stream

8.5.5.3.1 SPC-2 (VOD) Data Rate per Stream is defined as the ratio of the SPC-2 (VOD) Data Rate to SPC-2 (VOD) Number of Streams.

8.5.5.3.2 All public references to this value must be labeled as “SPC-2 (VOD) Data Rate per Stream”.

8.5.5.4 SPC-2 (VOD) Price-Performance

8.5.5.4.1 SPC-2 (LDQ) Price-Performance is defined as the ratio of the Total System Price, as defined in Clause 9.1.6, to SPC-2 (VOD) MBPS™.

8.5.5.4.2 All public references to this price-performance value must be labeled as “SPC-2 (VOD) Price-Performance”.

8.6 SPC-2 Test-Specific Reported Data – Public Use Requirements

8.6.1 Referencing Non-Local Currency Reported Data

A public reference, which includes an SPC-2 Test-Specific price-performance element, for an SPC-2 Result that uses non-local currency pricing (Clause 9.2.4.2) must include a clear statement of the currency used and the “target country” (Clause 9.2.3). For example, “SPC-2 Pricing is in U.S. dollars for product availability, sales, and support in People’s Republic of China”.

8.6.2 Referencing a Single SPC-2 Result

Any element in the SPC-2 Test-Specific data reported in the Executive Summary (Table 10-10: SPC-2 Reported Data) may be used in public reference as a lead item or point of emphasis under the following conditions:

1. If the element is a composite (LFP or LDQ) or VOD data item, all related composite or VOD elements must be stated together at some point in the public reference. For example, if SPC-2 (LDQ) Data Rate is referenced, both SPC-2 (LDQ) Data Rate and SPC-2 (LDQ) Price-Performance must be stated together in the public reference.
2. If the element is a Test Run Sequence data item, all elements reported for the Test Run Sequence must be stated together at some point in the public reference. For example, if SPC-2 (LFP, Read, 1024 KiB) Data Rate is referenced, the following must be stated together at some point in the public reference:
 - SPC-2 (LFP, Read, 1024 KiB) Data Rate
 - SPC-2 (LFP, Read, 1024 KiB) Number of Streams
 - SPC-2 (LFP, Read, 1024 KiB) Data Rate per Stream
3. The referenced SPC-2 Result must include either the complete set of SPC-2 Reported Data or the URL defined in Clause 8.4.2.1.
4. The public reference must include the “current as of” date.
5. If the public reference consists of printed or displayed materials, the required items in #1, #2, #3 and #4 must appear as a set of information using the same font style, font size, and text clarity. The set of information may appear as a text paragraph or table of information.

8.6.3 Comparing Two or More SPC-2 Results

Any element in the SPC-2 Test-Specific data may be used in public reference to compare two or more SPC-2 results under the following conditions.

1. If the element is a composite (LFP or LDQ) or VOD item, all related composite or VOD elements for each SPC-2 result must be stated together at some point in the public reference. For example, if SPC-2 (LDQ) Data Rate is referenced, both SPC-2 (LDQ) Data Rate and SPC-2 (LDQ) Price-Performance for each SPC-2 result must be stated together in the public reference.
2. If the element is a Test Run Sequence data item, all data items reported for the Test Run Sequence in each SPC-2 result must be stated together at some point in the public reference. For example, if SPC-2 (LFP, Read, 1024 KiB) Data Rate is referenced, the following must be stated together for each SPC-2 result at some point in the public reference:
 - SPC-2 (LFP, Read, 1024 KiB) Data Rate
 - SPC-2 (LFP, Read, 1024 KiB) Number of Streams
 - SPC-2 (LFP, Read, 1024 KiB) Data Rate per Stream
3. Each referenced SPC-2 Result must include either the complete set of SPC-2 Reported Data or the URL defined in Clause 8.4.2.1.
4. The public reference must include the “current as of” date.
5. If the public reference consists of printed or displayed materials, the required items in #1, #2, #3, and #4 must appear as a set of information using the same font style, font size, and text clarity. The set of information may appear as a text paragraph or table of information.

Clause 9: Pricing

This clause defines the components and methodology necessary to calculate required three-year pricing and the SPC-2 price-performance primary metric. The fundamental premise of this clause is that what is tested is priced and what is priced is tested.

9.1 Priced Components

The components to be priced include the hardware and software components present in the Tested Storage Configuration (TSC), any additional operational components required by the TSC, and three-year maintenance on all of the above components.

9.1.1 Tested Storage Configuration (TSC)

The TSC represents the physical configuration that is physically present during the benchmark measurement as defined in Clause 4.5. The TSC when used in pricing must represent a customer orderable configuration. To allow the use of a valid measurement configuration that may not represent a customer orderable configuration, the customer orderable configuration documented in the Full Disclosure Report may differ, as described in Clause 9.1.2, from the TSC.

9.1.2 Priced Storage Configuration

The Priced Storage Configuration represents a customer orderable configuration. If the TSC, without modification, is customer orderable, it is also the Priced Storage Configuration.

In cases where the TSC is a valid measurement configuration but not a customer orderable configuration, the TSC and Priced Storage Configuration will differ. In those cases, the Priced Storage Configuration will be comprised of the TSC with the appropriate components added or deleted to create a customer orderable configuration.

For example, consider a configuration in which a portion of the Physical Storage Capacity (Clause 2.2) is not physically connected to the TSC, and the TSC can be ordered without that unused storage. In this case, the Priced Storage Configuration would not include the unused storage.

A second example would be a configuration in which all of the Physical Storage Capacity is used in the benchmark, but that specific storage capacity is not orderable. The amount of storage included in the pricing would be adjusted to create an orderable configuration, again resulting in a Priced Storage Configuration that differs from the TSC.

In those cases where there is deletion or addition of components to create a customer orderable configuration, the customer orderable configuration must be capable of providing at least the same level of reported performance as the Benchmarked TSC. The intent of this requirement is to ensure that any component change to the Benchmarked TSC be performance-neutral.

9.1.3 Host System

If the Host System is included as a TSC component based on Clause 4.5.1, the Host System is considered a part of the Priced Storage Configuration and must be priced.

9.1.4 Additional Operational Components

9.1.4.1 Additional products explicitly required for the operation, administration, or maintenance of the Priced Storage Configuration must be included.

9.1.4.2 Copies of the software used by the TSC, on appropriate media, and a software load device, if required for initial load or maintenance updates, must be included.

9.1.4.3 The price of all cables used to connect components of the TSC must be included.

9.1.5 Maintenance

9.1.5.1 Hardware maintenance and software support, no matter what it is called by the vendor, provides the following:

- Acknowledgement of new and existing problems within four (4) hours.
- On-site presence of a qualified maintenance engineer or provision of a customer replaceable part within four (4) hours of the above acknowledgement for any hardware failure that results in an inoperative Priced Storage Configuration that can be remedied by the repair or replacement of a Priced Storage Configuration component. In either case, the remedy will result in resumption of operation.

Comment: Resumption of operation means the Priced Storage Configuration must be returned to the same state/configuration that was present before the failure.

- Commitment to fix software defects within a reasonable time.

9.1.5.2 The maintenance pricing must be independent of actual failure rates over the three-year period, no matter how many failures occur during that period. The use of Mean Time Between Failure (MTBF) data to directly compute the maintenance cost for this benchmark is precluded. The hardware maintenance pricing requirements cannot be met by pricing based on the cost to fix specific failures, even if the failure rate is calculated from MTBF data.

9.1.5.3 Hardware maintenance and software support must be configured using standard pricing which covers 7 days per week, 24 hours per day coverage, either on-site, or if available as standard offering, via a central support facility for a duration of at least three years (36 months).

9.1.6 Calculation of Priced Storage Configuration Pricing

Calculation of the three-year pricing, known as Total System Price, includes:

- The cost of the Priced Storage Configuration as defined in Clauses 9.1.2.
- The cost of the Host System(s) that are considered TSC components as defined in Clause 9.1.3.
- The cost of additional products (software or hardware) required for customary operation, administration and maintenance of the TSC for a period of three years as described in Clause 9.1.4.
- Hardware maintenance and software support as described in Clause 9.1.5.
- All applicable tariffs, duties, and import fees, when appropriate, if those costs are not included in the listed product prices.

Specifically excluded from the pricing calculation are the following:

- Components necessary for the execution of the benchmark but do not provide any storage functionality and do not enhance the measured performance of the Tested Storage Configuration.
- Software, which is not a third-party product, that meets the exclusions listed in Clause 4.5.1.
- The cost of maintenance for HBA(s) included in the Priced Storage Configuration.
- Any associated shipping costs.

9.2 Pricing Methodology

The pricing methodology must reflect the cost of operation of the Benchmark Configuration using packages and discounts commonly practiced and generally available products. This cost must be disclosed in a line item fashion using local pricing.

9.2.1 Packages and Discounts

Packaging and pricing that are generally available to customers are acceptable. Promotional and/or limited availability offerings are explicitly excluded. Revenue discounts based on total price are permissible. Any discount must be only for the configuration being priced and cannot be based on past or future purchases. Individually negotiated discounts are not permitted. Special customer discounts (e.g., GSA schedule, educational schedule) are not permitted. This is a one time, stand-alone purchase.

- 9.2.1.1 Generally available discounts for the priced configuration are allowed.
- 9.2.1.2 Generally available packaged pricing is allowed.
- 9.2.1.3 Assumptions of other purchases, other sites with similar systems, or any other assumption that relies on the principle that the customer has made any other purchase from the vendor are specifically prohibited.
- 9.2.1.4 For all hardware components used in the priced system, the cost must be the price of a new component (i.e., not reconditioned or previously owned).
- 9.2.1.5 For Test Sponsor(s) who have only indirect sales channels, pricing must be actual generally available pricing from indirect channels that meet all other requirements of .
- 9.2.1.6 Maintenance may be bundled as a component of package pricing. In that case, the maintenance component of the package must be clearly identified in the description of the bundle/package. A Test Sponsor may also include a standard multi-year maintenance option as a separately priced component. In cases where there is not such a 'bundling' of maintenance or a standard multi-year maintenance options is not available, the three-year maintenance cost shall be computed as three times the one-year maintenance cost. If maintenance is priced in that manner, a discount based on pre-payment in excess of 12 months is prohibited.

9.2.2 Product Availability

- 9.2.2.1 The Priced Storage Configuration is the actual configuration the customer would purchase. However, vendors may announce new products and disclose benchmark results before new products have actually shipped. This is allowed, but any use of benchmark-special implementations is specifically disallowed (see Clause 0.2).
- 9.2.2.2 Clause 0.2 requirements must be fulfilled with respect to the set of possible customers in the specified "target country" (*Clause 9.2.3*).

- 9.2.2.3 All hardware and software used in the calculations must be announced and generally orderable by customers.
- 9.2.2.4 Each product or collection of products that comprise the priced configuration must have an Availability Date, which is a date such that it is committed that by that date all requirements of Clause 0.2 will be fulfilled for that product or collection, including delivery for general availability.
- 9.2.2.5 The Priced Storage Configuration Availability Date (Clause 9.2.2.4) must not exceed three months beyond the SPC-2 Full Disclosure Report submittal date.

***Comment:** The essence of the Priced Storage Configuration Availability Date is the ability to take physical delivery of an integrated configuration that is identical to the Priced Storage Configuration, achieves the reported SPC-2 performance, and demonstrates fulfillment of all the requirements of Clause 0.2.*

- 9.2.2.6 The Test Sponsor must disclose all effective dates of the reported prices

9.2.3 “Target Country” Requirements

- 9.2.3.1 The “target country” is the country in which the Priced Storage Configuration is available for sale no later than the Priced Storage Configuration Availability Date (Clause 9.2.2.4) and in which the required hardware maintenance and software support (Clause 9.1.5) is provided either directly from the Test Sponsor or indirectly via a third-party supplier.
- 9.2.3.2 Priced Storage Configuration pricing, as well as any included discounts, must be available to all customers in the “target country”.

9.2.4 Pricing Currency

- 9.2.4.1 Local Currency SPC-2 pricing may be in the currency of the “target country” where the SPC-2 Priced Storage Configuration product availability, sales and support requirements would be met.
- 9.2.4.2 Non-Local Currency SPC-2 pricing may be in a currency other than the currency of the “target country” if all of the following requirements are met.
 - 9.2.4.2.1 The “target country” requirements (Clause 9.2.3) must be met.
 - 9.2.4.2.2 The Test Sponsor must disclose the country that is the source of the non-local currency used in the SPC-2 pricing.
 - 9.2.4.2.3 Public statement requirements that include SPC-2 Price-Performance and/or SPC-2 Total Price are listed in Clause 8.4.1.

9.2.5 Third-Party Pricing

- 9.2.5.1 In the event that any hardware, software, or maintenance is provided by a third party not involved as a Test Sponsor of the benchmark, the pricing must satisfy all requirements for general availability, standard volume discounts, and full disclosure.

- 9.2.5.2 The Test Sponsor is required to clearly identify all the items, components and services that are not acquired from the Test Sponsor. Any third party supplier's items and prices, including discounts, are subject to the same disclosure requirements as those components supplied by the Test Sponsor. Discounts shall not be dependent on purchases from any other suppliers.
- 9.2.5.3 Any pricing that is not directly offered by the Test Sponsor and not derived from the third party supplier's generally available pricing and discounts must be guaranteed by the third party in a written price quotation. The quotation must be valid for a period not less than 60 days from the date the results are submitted.
- 9.2.5.4 Third party's written quotations must be included in the Full Disclosure Report and must state:
- That the quoted prices are generally available;
 - The time period for which the prices are valid;
 - The basis of all discounts;
 - Any terms and conditions that apply to the quoted prices.

9.3 Required Reporting

9.3.1 Pricing Spreadsheet

- 9.3.1.1 The pricing spreadsheet details how the three-year cost of ownership is computed. It contains the prices, discounts, warranty information, and maintenance cost for all the hardware and software components in the Priced Storage Configuration. Price disclosure shall be presented in a structured fashion to enhance clarity and comparability between test results.
- 9.3.1.2 The **reference price** of a component or subsystem is defined as the price at which it could be ordered individually from the vendor or designated third-party supplier.
- 9.3.1.3 The pricing spreadsheet must be included in the Full Disclosure Report (see Clause 10: Full Disclosure) and must include the following items for each component in the Priced TSC:
- Part name or brief description
 - Part number
 - Source of the component, whether from a Test Sponsor or a third party (note: this can be a index into a list of component sources provided that list is included in the pricing spreadsheet)
 - Reference price of the component (see Clause 9.3.1.2)
 - Quantity of the component used in the priced configuration
 - The extended price of the component, based on the reference price of the component, the quantity included in the priced configuration and any component-level discounting
 - Three-year maintenance cost (including any discount for pre-payment, see Clause 9.2.1.6, or a notation that maintenance for the part is included in another maintenance charge.

- If the component is a bundle/package of parts, as allowed by Clause 9.2.1, the above items apply to the bundle but each item in the bundle/package must be clearly identified in the description of bundle/package.
- Components required to configure the Priced Storage Configuration that have an aggregate price less than 0.1% of the Priced Storage Configuration may be listed as a single line item with a description of the collection of components, e.g., "Miscellaneous Cables."

9.3.1.4 The total price of the Priced Storage Configuration and its associated three-year maintenance must be included in the pricing spreadsheet. The total price must be stated in the minimum level of negotiable detail for the pricing currency, e.g. U.S. dollars and cents.

9.3.1.5 The percentage, amount, and basis (including type and justification) of all discounts listed must be disclosed. A tabular summary may be employed to simplify the presentation.

Comment: *Thresholds for such discounts need not be disclosed.*

9.3.1.6 While package pricing is allowed, the level of discount obtained through such packages shall be disclosed by reporting the individual reference price for each component in the pricing spreadsheet (see Clause 9.3.1.2).

Comment: *This requirement does not apply to components that are not sold separately, other than as repair parts.*

9.3.1.7 The pricing spreadsheet shall contain the following text:

Prices used in SPC benchmarks reflect the actual prices a customer would pay for a one-time purchase of the stated components. Individually negotiated discounts are not permitted. Special prices based on assumptions about past or future purchases are not permitted. All discounts reflect standard pricing policies for the listed components. For complete details, see the pricing sections of the SPC benchmark specifications. If you find that the stated prices or maintenance levels are not available according to these terms, please inform the SPC at spcadmin@storageperformance.org.

Comment: *This wording is intended to assure that SPC pricing is viewed in an appropriate context, and to encourage the participation of consumers of SPC data is ensuring that the pricing methodologies are properly adhered to.*

Clause 10: Full Disclosure Report (FDR)

10.1 Required Graphs and Data Tables

Clauses 10.1.1-10.1.9 describe all of the graphs and associated data tables that are required to appear in the SPC-2 Full Disclosure Report (FDR). Each clause will describe the required content as well as the format and appearance of each graph and its associated data table. The source of all data illustrated in each graph and presented in its associated data table is the appropriate SPC-2 Test Run Result File.

The required location within the FDR of each graph and associated table is described in Clause 10.6.9.

10.1.1 Average Data Rate (*Large File Processing and Large Database Query*)

This FDR component consists of a graph and associated data table that illustrates the average Data Rate, in MB per second, for each Test Run within the Large File Processing (LFP) Test or the Large Database Query (LDQ) Test. A separate graph and associated data table is required for each of the two Tests.

Each Average Data Rate graph and associated data table is required to have the format, content, and appearance illustrated in Table 10-1 and Figure 10-1.

Table 10-1: Average Data Rate Data Table (*Large File Processing Test*)

Test Run Sequence	1 Stream	8 Streams	16 Streams	32 Streams	64 Streams
Write 1024KiB	204.05	745.99	882.62	1,347.33	1,450.38
Test Run Sequence	1 Stream	8 Streams	16 Streams	33 Streams	66 Streams
Write 256KiB	183.16	718.77	877.92	1,340.75	1,450.69
Test Run Sequence	1 Stream	8 Streams	16 Streams	32 Streams	64 Streams
Read/Write 1024KiB	223.57	856.09	1,137.00	1,660.30	2,025.30
Test Run Sequence	1 Stream	8 Streams	17 Streams	34 Streams	68 Streams
Read/Write 256KiB	193.66	862.73	1,151.00	1,662.03	1,989.97
Test Run Sequence	1 Stream	8 Streams	16 Streams	32 Streams	64 Streams
Read 1024KiB	156.06	974.56	1,337.76	2,011.12	2,111.79
Test Run Sequence	1 Stream	9 Streams	18 Streams	36 Streams	72 Streams
Read 256KiB	155.56	919.61	1,275.70	1,952.05	2,205.83

Figure 10-1: Average Data Rate Graph (Large File Processing Test)

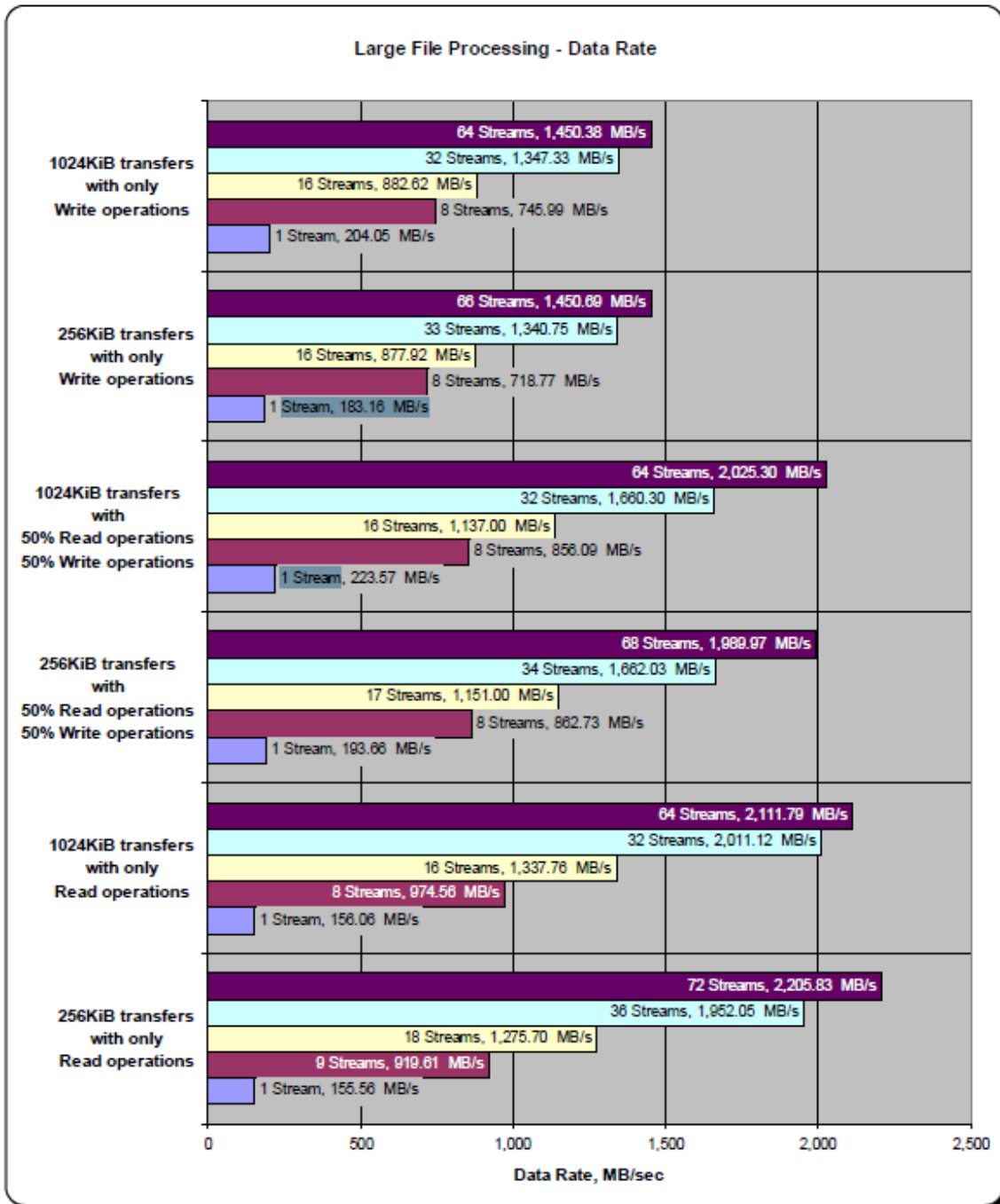

10.1.2 Average Data Rate per Stream (*Large File Processing and Large Database Query*)

This FDR component consists of a graph and associated data table that illustrates the average Data Rate, in MB per second, per Stream for each Test Run within the Large File Processing (LDQ) Test or the Large Database Query (LDQ) Test. A separate graph and associated data table is required for each of the two Tests.

Each Average Data Rate per Stream graph and associated data table is required to have the format, content, and appearance illustrated in Table 10-2 and

Figure 10-2.

Table 10-2: Average Data Rate per Stream Data Table (*Large Database Query Test*)

Test Run Sequence	1 Stream	2 Streams	4 Streams	9 Streams	18 Streams
1024KiB w/ 4 IOs/Stream	226.94	183.09	99.98	44.99	22.49
Test Run Sequence	1 Stream	2 Streams	4 Streams	9 Streams	18 Streams
1024KiB w/ 1 IO/Stream	144.14	111.41	64.40	41.46	22.45
Test Run Sequence	1 Stream	3 Streams	7 Streams	15 Streams	30 Streams
64KiB w/ 4 IOs/Stream	155.57	112.60	53.37	25.00	12.50
Test Run Sequence	1 Stream	3 Streams	7 Streams	15 Streams	30 Streams
64KiB w/ 1 IO/Stream	78.89	59.89	39.80	24.12	12.49

Figure 10-2: Average Data Rate per Stream Graph (Large Database Query Test)

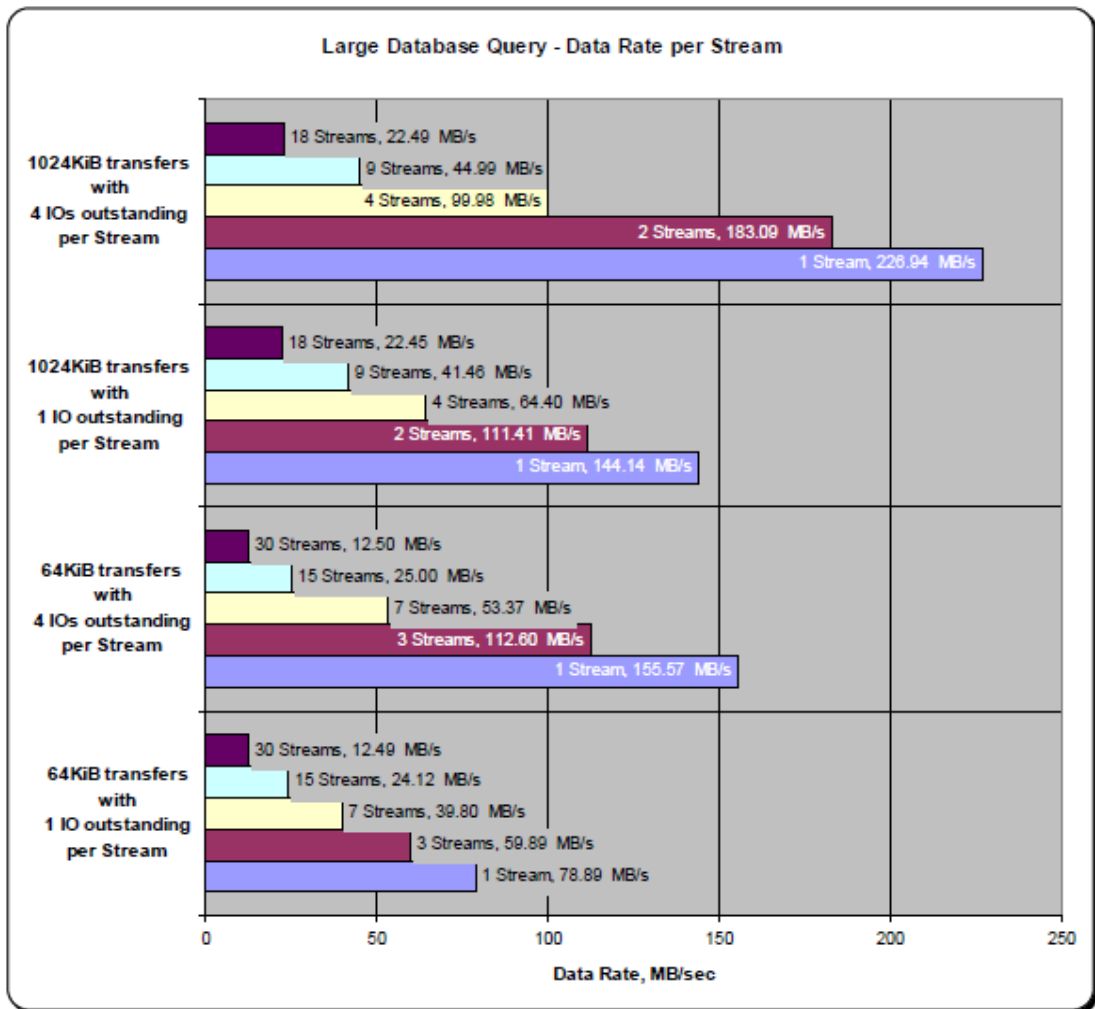

10.1.3 Average Response Time (*Large File Processing and Large Database Query*)

This FDR component consists of a graph and associated data table that illustrates the average Response Time for each Test Run within the Large File Processing (LFP) Test or the Large Database Query (LDQ) Test. A separate graph and associated data table is required for each of the two Tests.

Each Average Response Time graph and associated data table is required to have the format, content, and appearance illustrated in Table 10-3 and Figure 10-3.

Table 10-3: Average Response Time Table (*Large File Processing Test*)

Test Run Sequence	1 Stream	8 Streams	16 Streams	32 Streams	64 Streams
Write 1024KiB	5.16	11.28	19.19	25.05	46.25
Test Run Sequence	1 Stream	8 Streams	16 Streams	33 Streams	66 Streams
Write 256KiB	1.43	2.92	4.83	6.30	11.55
Test Run Sequence	1 Stream	8 Streams	16 Streams	32 Streams	64 Streams
Read/Write 1024KiB	4.68	9.91	14.79	20.20	33.14
Test Run Sequence	1 Stream	8 Streams	17 Streams	34 Streams	68 Streams
Read/Write 256KiB	1.34	2.44	3.66	5.04	8.42
Test Run Sequence	1 Stream	8 Streams	16 Streams	32 Streams	64 Streams
Read 1024KiB	6.76	8.61	12.57	16.75	31.80
Test Run Sequence	1 Stream	9 Streams	18 Streams	36 Streams	72 Streams
Read 256KiB	1.69	2.28	3.31	4.30	7.61

Figure 10-3: Average Response Time (*Large File Processing Test*)

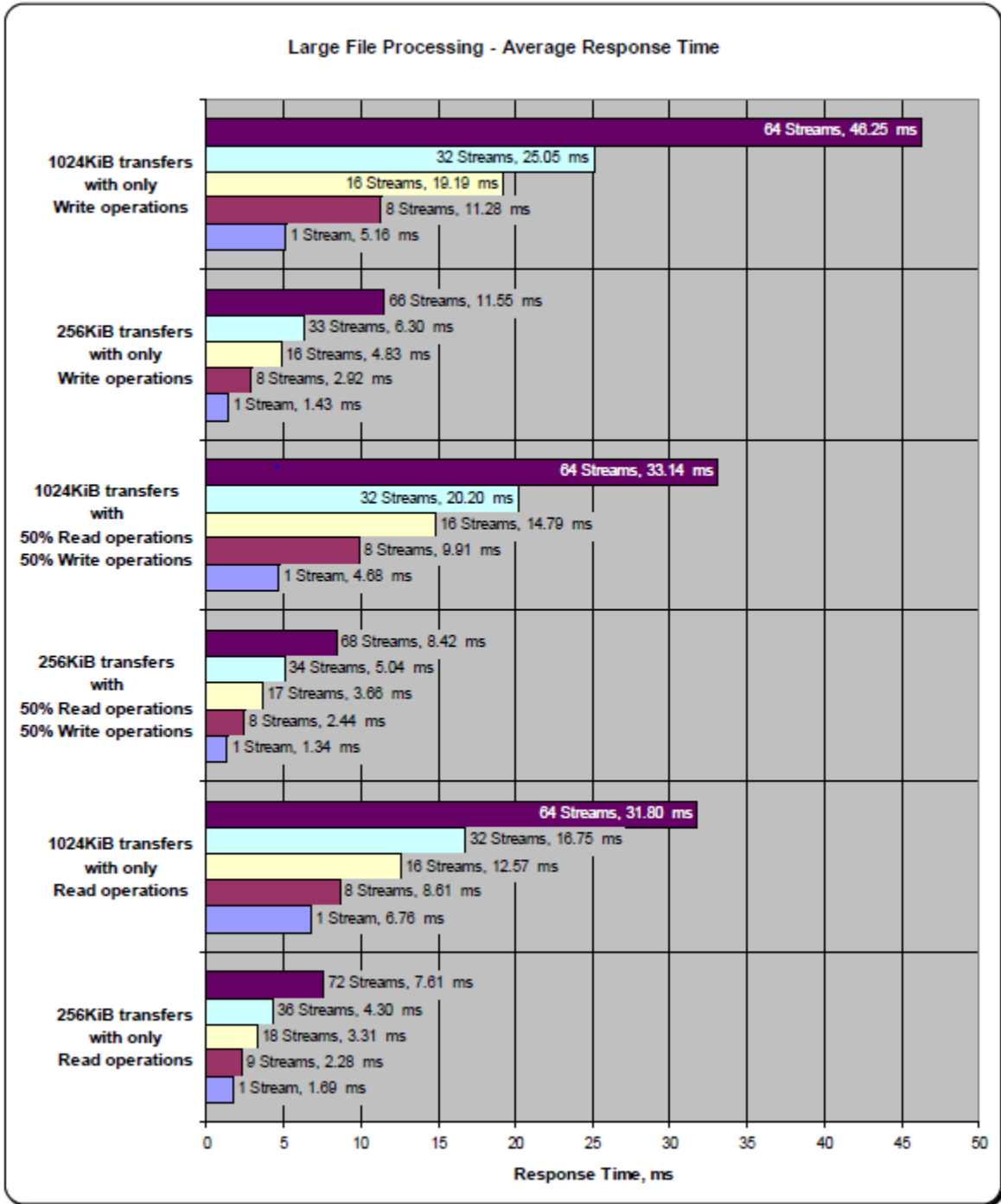

10.1.4 Average Data Rate by Interval (*LFP and LDQ*)

This FDR component consists of a graph and associated data table that illustrates the average Data Rate, in MB per second, which occurred during each specified interval of a Test Run. The specified interval for Large File Processing (LFP) and Large Database Query (LDQ) Test Runs is five seconds.

The results from each of the five Test Runs (maximum Stream value, three intermediate Stream values, and single Stream) associated with a Test Run Sequence may be contained in a single graph and associated data table.

Each Average Data Rate by Interval (LFP and LDQ) graph and associated data table is required to have the format, content, and appearance illustrated in Figure 10-4, Table 10-4, and Table 10-5.

Figure 10-4: Average Data Rate by Interval Graph (*LFP*)

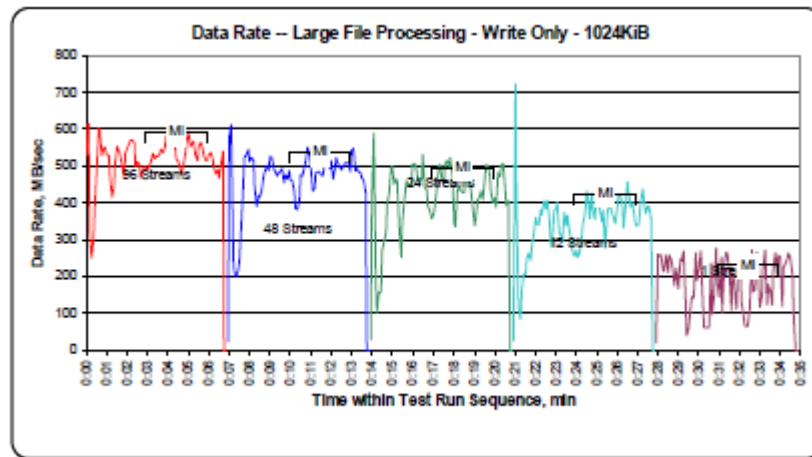

10.1.5 Average Data Rate per Stream by Interval (*LFP* and *LDQ*)

This FDR component consists of a graph and associated data table that illustrates the average Data Rate, in MB per second, per Stream which occurred during each specified interval of a Test Run. The specified interval for Large File Processing (*LFP*) and Large Database Query (*LDQ*) Test Runs is five seconds.

The results from each of the five Test Runs (maximum Stream value, three intermediate Stream values, and single Stream) associated with a Test Run Sequence may be contained in a single graph and associated data table.

Each Average Data Rate per Stream by Interval (*LFP* and *LDQ*) graph and associated data table is required to have the format, content, and appearance illustrated in Figure 10-5, Table 10-4, and Table 10-5.

Figure 10-5: Average Data Rate per Stream by Interval Graph (*LFP*)

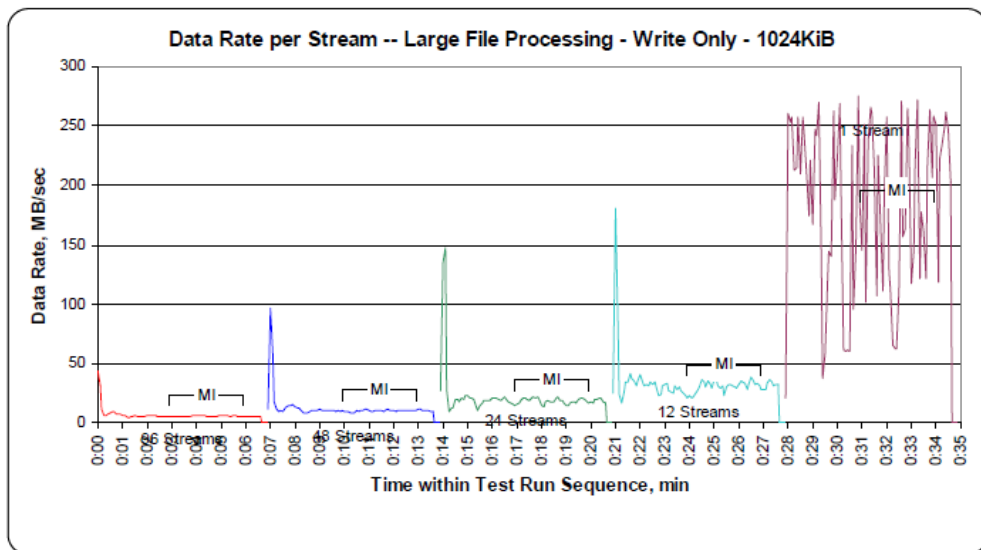

10.1.6 Average Response Time by Interval (LFP and LDQ)

This FDR component consists of a graph and associated data table that illustrates the average Response Time, in milliseconds, which occurred during each specified interval of a Test Run. The specified interval for Large File Processing (LFP) and Large Database Query (LDQ) Test Runs is five seconds.

The results from each of the five Test Runs (maximum Stream value, three intermediate Stream values, and single Stream) associated with a Test Run Sequence may be contained in a single graph and associated data table.

Each Average Response Time by Interval (LFP and LDQ) graph and associated data table is required to have the format, content, and appearance illustrated in Figure 10-6, Table 10-4, and Table 10-5.

Figure 10-6: Average Data Rate per Stream by Interval Graph (LFP)

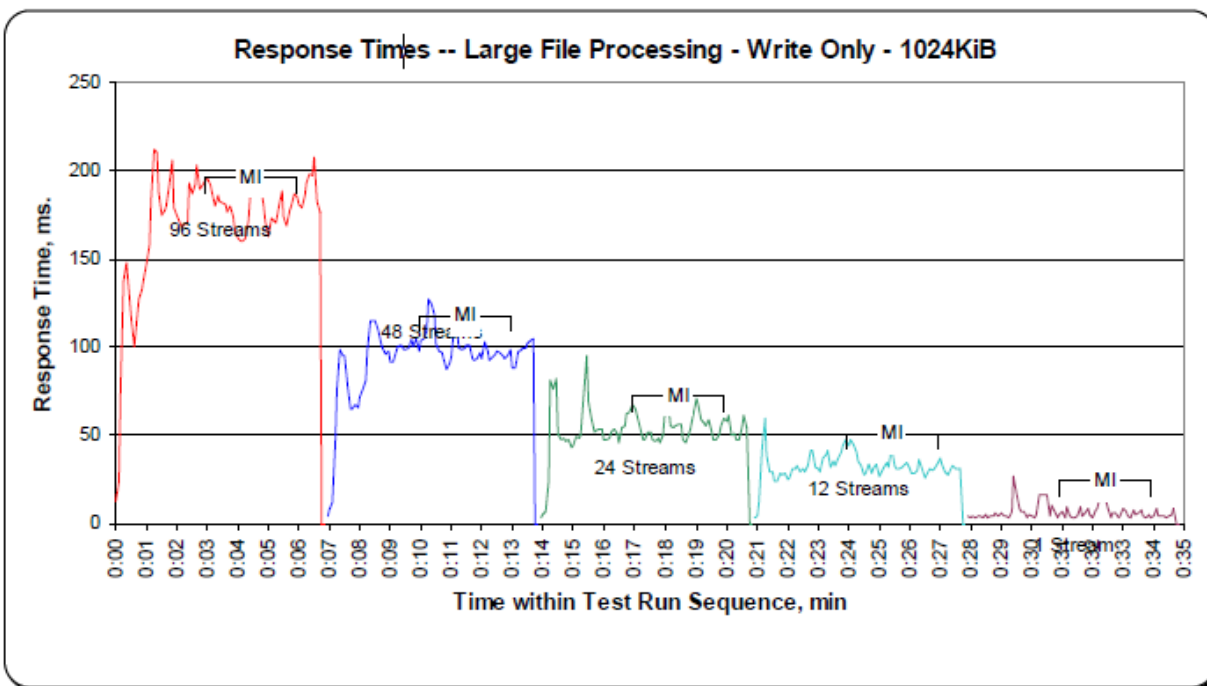

Table 10-4: Average Date Rate, Average Data Rate per Stream, and Average Response Time by Interval Data Table (LFP) – Ramp-Up Period

TR1			TR2			TR3			TR4			TR5			
Test Run Sequence Time	96 Streams		Response Time, ms	48 Streams		Response Time, ms	24 Streams		Response Time, ms	12 Streams		Response Time, ms	1 Stream		
	Data Rate, MB/sec	Data Rate / Stream, MB/sec		Data Rate, MB/sec	Data Rate / Stream, MB/sec		Data Rate, MB/sec	Data Rate / Stream, MB/sec		Data Rate, MB/sec	Data Rate / Stream, MB/sec		Data Rate, MB/sec	Data Rate / Stream, MB/sec	
0:00:00	528.20	44.02	13.36	22.60	11.30	4.51	27.40	27.40	3.89	25.00	25.00	3.83	20.60	20.60	4.04
0:00:05	615.20	30.76	24.37	579.80	96.63	7.58	403.80	134.60	5.47	723.60	180.90	4.44	260.80	260.80	3.83
0:00:10	323.40	11.15	73.31	611.20	55.56	12.07	589.80	147.45	6.51	401.60	80.32	12.24	253.40	253.40	3.94
0:00:15	250.40	6.11	137.37	249.20	17.80	47.45	193.00	27.57	24.07	118.20	23.64	42.19	257.20	257.20	3.88
0:00:20	304.00	6.20	147.98	214.00	11.26	75.03	103.40	9.40	81.15	83.80	16.76	59.72	212.40	212.40	4.71
0:00:25	380.80	6.80	136.43	200.00	9.52	98.55	154.80	12.90	76.17	154.80	25.80	38.52	215.00	215.00	4.65
0:00:30	494.00	8.52	116.07	220.00	10.00	95.58	158.00	12.15	81.97	204.80	34.13	29.37	257.00	257.00	3.89
0:00:35	604.60	9.45	100.74	242.00	9.68	95.24	269.80	19.27	50.75	204.20	34.03	29.41	209.20	209.20	4.78
0:00:40	597.20	8.91	108.88	341.40	12.19	78.20	294.60	19.64	47.44	247.60	41.27	24.24	257.80	257.80	3.87
0:00:45	529.40	7.46	127.10	460.40	13.95	64.87	317.60	17.64	48.52	264.00	37.71	24.62	242.60	242.60	4.12
0:00:50	550.20	7.34	131.98	523.20	14.53	64.95	395.20	20.80	46.47	243.80	34.83	28.68	210.00	210.00	4.75
0:00:55	552.00	7.17	137.87	531.80	14.77	67.82	424.80	20.23	47.75	276.20	30.69	27.72	174.20	174.20	5.75
0:01:00	527.40	6.51	147.44	545.00	15.14	66.08	495.40	22.52	43.29	316.00	35.11	28.52	221.40	221.40	4.50
0:01:05	528.00	6.29	157.13	512.20	13.13	72.11	498.40	22.65	43.97	360.20	40.02	25.01	167.40	167.40	5.99
0:01:10	469.40	5.33	183.09	522.80	12.75	76.09	451.00	20.50	48.88	344.00	34.40	26.24	246.80	246.80	4.05
0:01:15	414.60	4.56	211.66	516.00	12.00	81.71	465.60	20.24	48.66	341.00	31.00	30.82	241.40	241.40	4.15
0:01:20	445.40	4.79	210.64	445.40	9.90	97.35	456.20	19.83	50.18	382.40	31.87	30.99	269.60	269.60	3.70
0:01:25	507.60	5.29	187.49	390.40	8.31	115.41	325.60	13.57	73.03	369.00	30.75	32.56	138.80	138.80	7.19
0:01:30	553.00	5.76	175.00	421.00	8.77	114.84	252.80	10.53	95.54	405.20	33.77	29.66	37.60	37.60	26.58
0:01:35	539.40	5.62	177.72	415.60	8.66	114.83	345.20	14.38	69.33	383.40	31.95	31.33	58.40	58.40	17.17
0:01:40	530.40	5.53	180.07	435.00	9.06	110.17	407.40	16.98	59.72	407.20	33.93	29.46	119.20	119.20	8.39
0:01:45	500.60	5.21	192.42	476.40	9.93	101.76	459.00	19.13	52.00	365.60	30.47	32.80	144.80	144.80	6.89
0:01:50	467.20	4.87	206.17	484.20	10.09	99.45	454.80	18.95	52.80	279.00	23.25	41.15	140.00	140.00	7.15
0:01:55	535.40	5.58	179.29	500.80	10.43	95.93	444.60	18.53	54.05	288.60	24.05	41.59	262.80	262.80	3.80
0:02:00	549.20	5.72	175.12	486.00	10.13	98.01	449.60	18.73	53.49	379.60	31.63	31.66	188.40	188.40	5.30
0:02:05	562.00	5.85	170.17	526.40	10.97	91.71	504.40	21.02	47.78	385.40	32.12	31.24	222.80	222.80	4.49
0:02:10	570.40	5.94	168.21	522.60	10.89	91.97	505.40	21.06	47.65	402.20	33.52	29.75	268.40	268.40	3.72
0:02:15	570.00	5.94	169.17	489.00	10.19	97.63	493.60	20.57	48.28	322.00	26.83	37.26	188.40	188.40	5.31
0:02:20	564.80	5.88	170.09	486.60	10.14	100.01	461.80	19.24	51.63	307.80	25.65	38.74	60.80	60.80	16.43
0:02:25	498.80	5.20	192.96	473.40	9.86	100.79	450.20	18.76	53.87	292.80	24.40	41.47	60.00	60.00	16.65
0:02:30	513.00	5.34	186.88	485.40	10.11	98.25	468.80	19.53	51.02	373.60	31.13	32.19	60.80	60.80	16.46
0:02:35	502.00	5.23	191.87	484.80	10.10	98.90	532.80	22.20	45.42	337.80	28.15	35.30	60.40	60.40	16.54
0:02:40	469.20	4.89	203.00	492.60	10.26	99.13	441.60	18.40	54.12	365.00	30.42	32.87	234.00	234.00	4.28
0:02:45	488.40	5.09	189.25	454.00	9.46	105.05	434.00	18.08	55.20	323.20	26.93	37.20	95.60	95.60	10.45
0:02:50	499.60	5.20	191.78	474.80	9.89	100.45	389.40	16.23	61.94	297.80	24.82	40.42	146.80	146.80	6.82
0:02:55	496.60	5.17	193.97	466.20	9.71	104.33	378.00	15.75	63.33	269.80	22.48	44.31	275.60	275.60	3.62
0:03:00	490.00	5.10	195.68	486.80	10.14	97.74	356.20	14.84	67.24	254.00	21.17	47.18	185.80	185.80	5.36

Table 10-5: Average Date Rate, Average Data Rate per Stream, and Average Response Time by Interval Data Table (LFP) – Measurement Interval, Run-Out, and Ramp-Down Periods

TR1	96 Streams			TR2	48 Streams			TR3	24 Streams			TR4	12 Streams			TR5	1 Stream		
Test Run Sequence Time	Data Rate, MB/sec	Data Rate / Stream, MB/sec	Response Time, ms	Test Run Sequence Time	Data Rate, MB/sec	Data Rate / Stream, MB/sec	Response Time, ms	Test Run Sequence Time	Data Rate, MB/sec	Data Rate / Stream, MB/sec	Response Time, ms	Test Run Sequence Time	Data Rate, MB/sec	Data Rate / Stream, MB/sec	Response Time, ms	Test Run Sequence Time	Data Rate, MB/sec	Data Rate / Stream, MB/sec	Response Time, ms
0:03:00	490.00	5.10	195.68	0:09:55	498.80	10.14	97.74	0:16:55	356.20	14.84	67.24	0:23:55	254.00	21.17	47.18	0:30:55	185.80	185.80	5.36
0:03:05	502.60	5.24	192.18	0:10:00	483.00	9.65	103.83	0:17:00	370.60	15.44	65.14	0:24:00	270.60	22.55	44.53	0:31:00	145.20	145.20	6.80
0:03:10	510.20	5.31	187.31	0:10:05	459.40	9.57	104.72	0:17:05	391.80	16.33	61.22	0:24:05	251.60	20.97	48.01	0:31:05	250.80	250.80	3.81
0:03:15	534.80	5.57	180.27	0:10:10	429.40	8.95	109.08	0:17:10	440.40	18.35	54.66	0:24:10	262.20	21.85	45.23	0:31:10	102.20	102.20	9.81
0:03:20	519.60	5.41	185.83	0:10:15	385.80	8.04	127.54	0:17:15	502.00	20.92	47.79	0:24:15	301.80	25.15	40.23	0:31:15	238.20	238.20	4.19
0:03:25	525.40	5.47	182.21	0:10:20	382.80	7.98	124.73	0:17:20	503.80	20.99	47.73	0:24:20	341.20	28.43	35.21	0:31:20	265.40	265.40	3.76
0:03:30	525.60	5.48	181.53	0:10:25	406.60	8.47	118.29	0:17:25	462.40	19.27	51.98	0:24:25	365.00	30.42	32.82	0:31:25	260.60	260.60	3.83
0:03:35	534.80	5.57	180.61	0:10:30	475.60	9.91	101.67	0:17:30	460.40	19.18	52.28	0:24:30	433.20	36.10	27.81	0:31:30	211.60	211.60	4.72
0:03:40	544.80	5.68	176.47	0:10:35	473.20	9.86	97.38	0:17:35	506.40	21.10	47.19	0:24:35	415.60	34.83	28.77	0:31:35	107.00	107.00	9.36
0:03:45	536.40	5.59	179.65	0:10:40	499.40	10.40	98.48	0:17:40	515.80	21.49	46.61	0:24:40	356.80	29.73	33.76	0:31:40	225.20	225.20	4.42
0:03:50	552.00	5.75	173.98	0:10:45	512.00	10.67	93.84	0:17:45	498.20	20.76	48.33	0:24:45	425.60	35.47	28.23	0:31:45	169.40	169.40	5.93
0:03:55	582.60	6.07	166.52	0:10:50	551.20	11.48	87.14	0:17:50	523.60	21.82	45.81	0:24:50	384.40	32.03	31.19	0:31:50	111.40	111.40	8.94
0:04:00	589.80	6.14	161.41	0:10:55	528.60	11.01	90.76	0:17:55	479.20	19.97	50.00	0:24:55	354.20	29.52	33.95	0:31:55	193.00	193.00	5.16
0:04:05	600.80	6.26	160.40	0:11:00	504.00	10.50	94.64	0:18:00	341.80	14.24	69.86	0:25:00	440.00	36.67	27.20	0:32:00	257.40	257.40	3.88
0:04:10	597.20	6.22	160.32	0:11:05	430.60	8.97	112.10	0:18:05	336.20	14.01	71.44	0:25:05	421.20	35.10	28.54	0:32:05	127.60	127.60	7.84
0:04:15	595.20	6.20	162.08	0:11:10	439.80	9.16	108.94	0:18:10	431.80	17.99	55.76	0:25:10	378.20	31.52	31.76	0:32:10	111.80	111.80	8.93
0:04:20	553.60	5.77	172.23	0:11:15	482.80	10.06	99.32	0:18:15	445.60	18.57	54.26	0:25:15	347.80	28.98	34.52	0:32:15	65.60	65.60	15.24
0:04:25	519.20	5.41	184.12	0:11:20	485.00	10.10	98.82	0:18:20	435.40	18.14	54.96	0:25:20	378.20	31.52	31.77	0:32:20	62.80	62.80	15.98
0:04:30	512.00	5.33	188.64	0:11:25	483.40	10.07	99.71	0:18:25	427.80	17.83	56.04	0:25:25	277.80	23.15	43.14	0:32:25	62.80	62.80	15.92
0:04:35	493.40	5.14	193.91	0:11:30	477.00	9.94	101.59	0:18:30	429.80	17.91	55.98	0:25:30	365.00	30.42	32.93	0:32:30	112.20	112.20	8.91
0:04:40	476.00	4.98	202.56	0:11:35	472.00	9.83	101.31	0:18:35	505.20	21.05	47.60	0:25:35	386.00	32.17	31.07	0:32:35	271.40	271.40	3.68
0:04:45	500.40	5.21	191.37	0:11:40	512.00	10.67	93.25	0:18:40	523.40	21.81	45.94	0:25:40	390.40	32.53	30.84	0:32:40	157.20	157.20	6.35
0:04:50	535.20	5.58	180.38	0:11:45	526.40	10.97	92.27	0:18:45	451.40	18.81	51.10	0:25:45	371.80	30.98	32.29	0:32:45	162.80	162.80	6.15
0:04:55	559.40	5.83	171.30	0:11:50	510.80	10.64	93.50	0:18:50	444.20	18.51	53.52	0:25:50	363.60	30.30	32.97	0:32:50	264.60	264.60	3.77
0:05:00	593.80	6.19	182.48	0:11:55	493.80	10.29	96.93	0:18:55	399.80	16.24	61.92	0:25:55	343.80	28.65	34.83	0:32:55	236.00	236.00	4.23
0:05:05	553.40	5.76	173.38	0:12:00	516.20	10.75	93.30	0:19:00	337.60	14.07	70.58	0:26:00	387.60	32.30	31.07	0:33:00	117.20	117.20	8.53
0:05:10	559.40	5.83	171.83	0:12:05	464.40	9.68	103.07	0:19:05	357.00	14.88	67.74	0:26:05	419.20	34.93	28.68	0:33:05	145.80	145.80	6.86
0:05:15	566.80	5.90	170.24	0:12:10	491.60	10.25	97.86	0:19:10	408.00	17.00	58.93	0:26:10	417.20	34.77	28.76	0:33:10	214.60	214.60	4.66
0:05:20	528.60	5.51	179.81	0:12:15	522.00	10.88	92.24	0:19:15	418.60	17.44	57.37	0:26:15	395.00	32.92	30.31	0:33:15	272.20	272.20	3.67
0:05:25	515.20	5.37	188.23	0:12:20	506.80	10.56	94.71	0:19:20	432.20	18.01	55.56	0:26:20	333.00	27.75	36.05	0:33:20	121.80	121.80	8.21
0:05:30	553.20	5.78	174.20	0:12:25	496.80	10.35	96.45	0:19:25	409.80	17.08	58.72	0:26:25	385.80	32.15	31.19	0:33:25	177.80	177.80	5.62
0:05:35	565.20	5.89	168.62	0:12:30	490.40	10.22	97.74	0:19:30	464.80	19.37	51.74	0:26:30	455.60	37.97	28.35	0:33:30	161.00	161.00	6.19
0:05:40	546.80	5.70	177.25	0:12:35	499.40	10.40	96.53	0:19:35	503.80	20.99	47.84	0:26:35	428.40	35.70	28.04	0:33:35	121.80	121.80	8.22
0:05:45	529.20	5.51	179.66	0:12:40	508.40	10.59	95.41	0:19:40	498.80	20.78	47.82	0:26:40	387.20	32.27	30.98	0:33:40	216.20	216.20	4.62
0:05:50	514.00	5.35	187.07	0:12:45	509.40	10.61	93.48	0:19:45	474.00	19.75	50.83	0:26:45	397.80	33.15	30.25	0:33:45	263.80	263.80	3.79
0:05:55	518.80	5.40	185.22	0:12:50	508.80	10.60	94.88	0:19:50	430.00	17.92	55.67	0:26:50	379.00	31.58	31.52	0:33:50	206.20	206.20	4.85
0:06:00	532.80	5.55	180.83	0:12:55	495.20	10.11	98.56	0:19:55	401.60	16.73	60.05	0:26:55	338.60	28.22	33.88	0:33:55	258.60	258.60	3.86
0:06:05	538.20	5.61	179.44	0:13:00	543.60	11.33	88.27	0:20:00	412.00	17.17	57.96	0:27:00	336.40	28.03	37.39	0:34:00	251.40	251.40	3.96
0:06:10	516.60	5.38	186.24	0:13:05	548.80	11.39	87.96	0:20:05	396.20	16.09	61.80	0:27:05	338.80	28.23	34.00	0:34:05	118.80	118.80	8.45
0:06:15	496.60	5.17	192.51	0:13:10	486.60	10.14	98.16	0:20:10	482.80	20.12	50.30	0:27:10	403.20	33.80	29.83	0:34:10	222.60	222.60	4.49
0:06:20	479.60	5.00	197.95	0:13:15	495.00	10.31	97.44	0:20:15	471.00	19.63	51.00	0:27:15	437.20	36.43	27.43	0:34:15	234.60	234.60	4.26
0:06:25	490.00	5.10	196.89	0:13:20	484.60	10.10	99.10	0:20:20	500.80	20.87	47.88	0:27:20	408.00	34.00	29.33	0:34:20	249.20	249.20	4.00
0:06:30	466.80	4.86	207.37	0:13:25	481.00	10.02	99.44	0:20:25	506.60	21.11	47.37	0:27:25	370.00	30.83	32.46	0:34:25	261.80	261.80	3.82
0:06:35	503.00	5.24	182.52	0:13:30	467.60	9.74	102.49	0:20:30	433.60	18.07	55.15	0:27:30	391.00	32.58	30.73	0:34:30	247.20	247.20	4.04
0:06:40	539.60	0.00	176.14	0:13:35	462.40	9.63	103.55	0:20:35	392.20	16.34	61.44	0:27:35	389.20	32.43	30.89	0:34:35	202.60	202.60	4.92
0:06:45	0.00	0.00	0.00	0:13:40	429.80	0.00	104.40	0:20:40	402.80	0.00	54.88	0:27:40	360.40	0.00	30.80	0:34:40	100.00	0.00	8.91
0:06:50	0.00	0.00	0.00	0:13:45	0.00	0.00	0.00	0:20:45	0.00	0.00	0.00	0:27:45	0.00	0.00	0.00	0:34:45	0.00	0.00	0.00
				0:13:50	0.00	0.00	0.00	0:20:50	0.00	0.00	0.00	0:27:50	0.00	0.00	0.00	0:34:50	0.00	0.00	0.00

10.1.7 Average Data Rate, Data Rate per Stream, and Response Time (VOD)

This FDR component consists of a data table that contains the average Data Rate, average Data Rate per Stream, and average Response Time for the Video on Demand Delivery (VOD) Test Run. The format, content, and appearance of the required table are illustrated in Table 10-6.

Table 10-6: Average Data Rate, Data Rate per Stream, and Response Time Table (VOD)

Number of Streams	500
Ramp-up Time, sec	0:20:00
Measurement Interval, sec	2:00:00
Average Data Rate, MB/sec	393.22
Per Stream Data Rate, MB/sec	0.79
Average Response Time, ms	29.49
Average Max Response Time, ms	69.56

10.1.8 Average Data Rate and Response Time by Intervals (VOD)

This FDR component consists of a data table and two graphs that illustrate the average Data Rate and average Response Time, which occurred during each sixty (60) second reporting interval for the Video on Demand Delivery (VOD) Test Run. Also included in the data table is the Data Rate by Stream, which occurred during each reporting interval. The format, content, and appearance of the required table and graphs are illustrated in Table 10-7 and Figure 10-7-Figure 10-9.

10.1.9 Maximum Response Time by Intervals (VOD)

This FDR component consists of a graph that illustrates the maximum Response Time that occurred during each sixty (60) second reporting interval for the Video on Demand Delivery (VOD) Test Run. The format, content, and appearance of the required graph is illustrated in Figure 10-9.

Table 10-7: Average Data Rate, Data Rate per Stream, and Response Time Table (VOD)

Test Run Sequence Time	Data Rate, MB/sec	Data Rate / Stream, MB/sec	Response Time, ms	Maximum Response Time, ms	Test Run Sequence Time	Data Rate, MB/sec	Data Rate / Stream, MB/sec	Response Time, ms	Maximum Response Time, ms	Test Run Sequence Time	Data Rate, MB/sec	Data Rate / Stream, MB/sec	Response Time, ms	Maximum Response Time, ms
0:01:00	44.02	0.69	3.56	19.78	0:51:00	393.22	0.79	29.70	64.11	1:41:00	393.21	0.79	29.38	72.35
0:02:00	108.68	0.77	4.74	21.29	0:52:00	393.22	0.79	29.77	65.87	1:42:00	393.21	0.79	29.66	77.95
0:03:00	168.91	0.78	6.20	23.62	0:53:00	393.19	0.79	29.84	63.83	1:43:00	393.22	0.79	29.61	69.16
0:04:00	210.67	0.78	7.27	27.46	0:54:00	393.20	0.79	29.65	63.66	1:44:00	393.20	0.79	29.44	63.96
0:05:00	252.39	0.78	8.25	30.04	0:55:00	393.23	0.79	29.62	65.12	1:45:00	393.22	0.79	29.25	69.75
0:06:00	293.16	0.78	9.74	36.87	0:56:00	393.20	0.79	29.52	63.76	1:46:00	393.24	0.79	29.18	68.06
0:07:00	321.79	0.78	11.31	37.30	0:57:00	393.23	0.79	29.66	64.32	1:47:00	393.21	0.79	29.10	76.59
0:08:00	345.80	0.78	13.16	40.40	0:58:00	393.20	0.79	29.49	64.13	1:48:00	393.19	0.79	29.39	78.60
0:09:00	371.80	0.78	18.67	52.55	0:59:00	393.19	0.79	29.58	64.00	1:49:00	393.20	0.79	29.36	75.87
0:10:00	388.19	0.79	26.13	63.92	1:00:00	393.23	0.79	29.78	66.54	1:50:00	393.19	0.79	29.41	65.50
0:11:00	393.21	0.79	29.31	65.72	1:01:00	393.21	0.79	29.53	74.29	1:51:00	393.28	0.79	29.24	65.14
0:12:00	393.20	0.79	29.23	65.69	1:02:00	393.21	0.79	29.85	78.97	1:52:00	393.22	0.79	29.26	65.59
0:13:00	393.20	0.79	29.34	66.56	1:03:00	393.22	0.79	30.11	74.55	1:53:00	393.27	0.79	23.27	56.49
0:14:00	393.21	0.79	29.32	65.48	1:04:00	393.20	0.79	29.75	69.63	1:54:00	393.23	0.79	29.18	65.31
0:15:00	393.23	0.79	29.31	64.78	1:05:00	393.25	0.79	29.66	65.39	1:55:00	393.21	0.79	29.50	65.74
0:16:00	393.21	0.79	29.48	64.18	1:06:00	393.21	0.79	29.63	70.20	1:56:00	393.23	0.79	29.48	64.73
0:17:00	393.22	0.79	29.56	65.36	1:07:00	393.22	0.79	29.72	66.41	1:57:00	393.22	0.79	29.59	65.96
0:18:00	393.22	0.79	29.11	64.50	1:08:00	393.24	0.79	29.55	64.91	1:58:00	393.23	0.79	29.84	67.22
0:19:00	393.20	0.79	29.37	64.17	1:09:00	393.21	0.79	29.63	65.68	1:59:00	393.23	0.79	29.72	67.65
0:20:00	393.22	0.79	29.47	66.33	1:10:00	393.19	0.79	29.66	66.24	2:00:00	393.21	0.79	29.71	68.87
0:21:00	393.20	0.79	29.42	74.97	1:11:00	393.21	0.79	29.98	63.72	2:01:00	393.21	0.79	29.84	71.69
0:22:00	393.19	0.79	29.33	79.76	1:12:00	393.19	0.79	29.86	63.99	2:02:00	393.21	0.79	29.75	70.56
0:23:00	393.21	0.79	29.62	71.15	1:13:00	393.24	0.79	29.80	64.22	2:03:00	393.22	0.79	29.66	72.76
0:24:00	393.24	0.79	29.82	75.62	1:14:00	393.20	0.79	29.57	63.31	2:04:00	393.22	0.79	29.61	75.47
0:25:00	393.22	0.79	29.85	70.09	1:15:00	393.22	0.79	29.60	63.80	2:05:00	393.24	0.79	29.73	76.29
0:26:00	393.21	0.79	29.70	75.46	1:16:00	393.20	0.79	29.71	64.26	2:06:00	393.23	0.79	29.58	73.86
0:27:00	393.21	0.79	29.78	67.79	1:17:00	393.20	0.79	29.74	65.12	2:07:00	393.23	0.79	29.61	72.65
0:28:00	393.20	0.79	29.97	76.41	1:18:00	393.16	0.79	29.95	64.02	2:08:00	393.23	0.79	29.82	74.60
0:29:00	393.21	0.79	29.56	71.24	1:19:00	393.20	0.79	29.87	65.31	2:09:00	393.22	0.79	29.92	73.98
0:30:00	393.22	0.79	29.60	69.71	1:20:00	393.24	0.79	30.10	65.08	2:10:00	393.20	0.79	29.65	72.05
0:31:00	393.23	0.79	29.41	70.03	1:21:00	393.23	0.79	30.23	71.10	2:11:00	393.23	0.79	29.58	71.76
0:32:00	393.21	0.79	29.27	70.46	1:22:00	393.21	0.79	29.76	80.63	2:12:00	393.22	0.79	29.45	70.53
0:33:00	393.24	0.79	29.06	68.98	1:23:00	393.23	0.79	29.60	78.32	2:13:00	393.22	0.79	29.40	71.57
0:34:00	393.23	0.79	29.11	69.20	1:24:00	393.24	0.79	29.52	77.96	2:14:00	393.22	0.79	29.47	70.66
0:35:00	393.22	0.79	29.11	68.41	1:25:00	393.22	0.79	29.37	69.76	2:15:00	393.21	0.79	29.86	72.04
0:36:00	393.21	0.79	29.17	68.05	1:26:00	393.19	0.79	29.23	68.21	2:16:00	393.20	0.79	29.87	72.13
0:37:00	393.20	0.79	29.18	68.12	1:27:00	393.23	0.79	29.41	70.07	2:17:00	393.21	0.79	30.00	72.10
0:38:00	393.21	0.79	29.11	67.48	1:28:00	393.20	0.79	29.28	68.93	2:18:00	393.24	0.79	29.68	72.56
0:39:00	393.21	0.79	29.17	67.15	1:29:00	393.22	0.79	29.27	65.82	2:19:00	393.21	0.79	29.74	72.77
0:40:00	393.22	0.79	29.16	68.66	1:30:00	393.22	0.79	29.26	64.53	2:20:00	393.24	0.79	29.31	71.37
0:41:00	393.21	0.79	29.34	81.97	1:31:00	393.22	0.79	29.28	63.16					
0:42:00	393.19	0.79	29.46	81.00	1:32:00	393.22	0.79	29.21	63.87					
0:43:00	393.22	0.79	29.68	90.92	1:33:00	393.24	0.79	29.12	62.32					
0:44:00	393.22	0.79	29.66	84.25	1:34:00	393.24	0.79	29.09	62.56					
0:45:00	393.21	0.79	29.51	71.32	1:35:00	393.21	0.79	29.31	64.83					
0:46:00	393.19	0.79	29.27	75.65	1:36:00	393.19	0.79	29.25	62.96					
0:47:00	393.21	0.79	29.25	66.96	1:37:00	393.22	0.79	29.39	64.02					
0:48:00	393.24	0.79	29.25	69.62	1:38:00	393.24	0.79	29.48	69.84					
0:49:00	393.21	0.79	29.30	65.03	1:39:00	393.21	0.79	29.44	64.85					
0:50:00	393.19	0.79	29.54	71.03	1:40:00	393.23	0.79	29.57	70.13					

Figure 10-7: Average Data Rate by Intervals Graph (VOD)

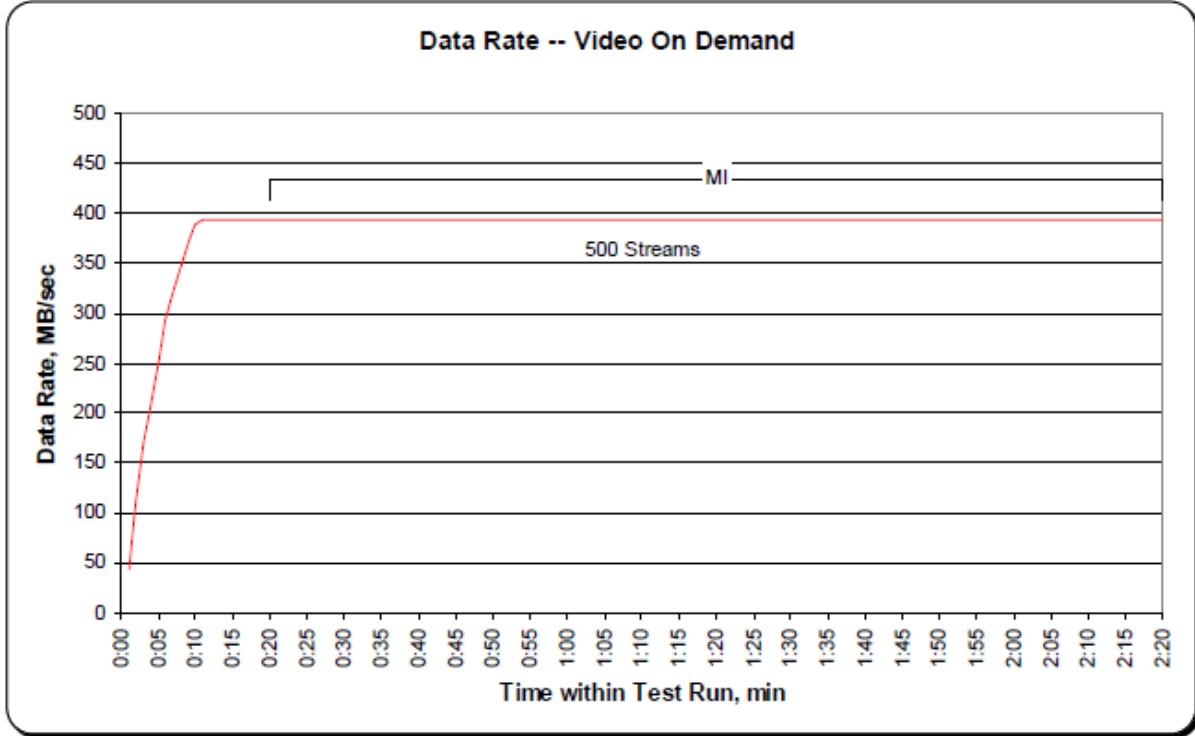

Figure 10-8: Average Response Time by Intervals Graph (VOD)

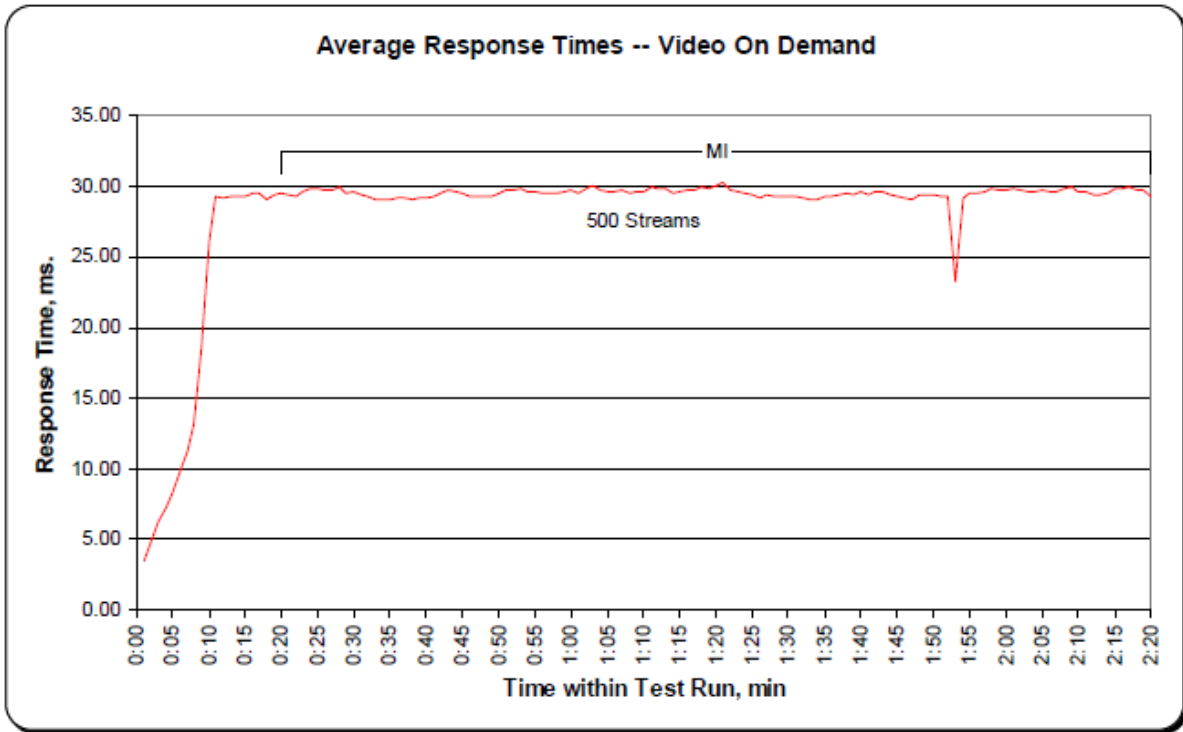
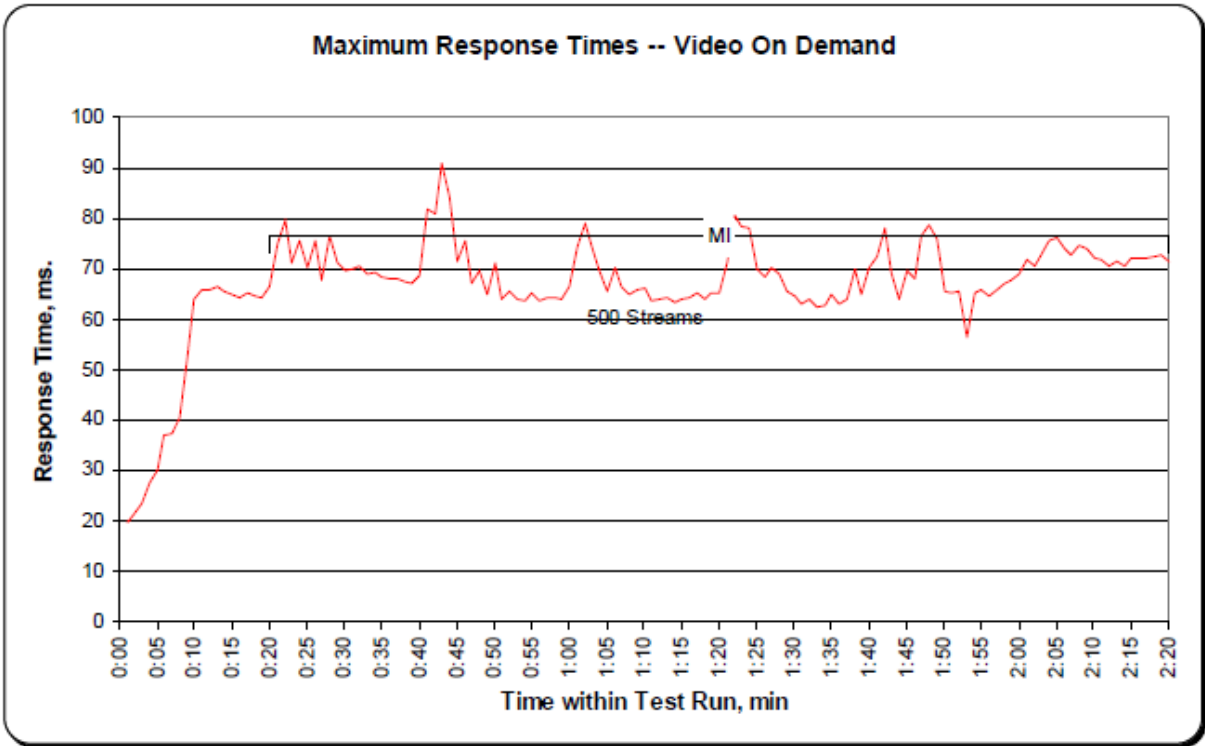

Figure 10-9: Maximum Response Time by Intervals Graph (VOD)



10.2 Full Disclosure Report Requirements

A Full Disclosure Report (FDR), submitted to the SPC Administrator, is required for each SPC-2 benchmark result.

10.2.1 Electronic PDF Format

The FDR must be submitted electronically as an Adobe PDF file after successful completion of the required SPC-2 Audit and prior to any public use of the benchmark information (see Clause 11.4.7).

10.2.2 Document Format

The FDR will consist of the content described in Clause 10.6.

The FDR will be written in the English language. Each page of the FDR will be formatted with a minimum of one inch side and top margins, one-half inch bottom margins, and each page will be numbered.

Graphs, tables, and illustrations will use a minimum of 8-point sans serif font such as Arial. The text of the FDR will use a minimum of 10-point serif font such as Century Schoolbook.

10.3 Full Disclosure Report Availability

The Full Disclosure Report must be readily available to the public at a reasonable charge, similar to charges for similar documents by that Test Sponsor. The Test Sponsor must have on file with the SPC, submit with the FDR, or include as a part of the FDR, a release that allows public disclosure of the FDR content.

10.4 Revisions to a Previously Submitted Full Disclosure Report

The following revisions may be made to a previously submitted Full Disclosure Report (FDR):

1. SPC-2 Price-Performance of existing SPC-2 results may be revised based on fully documented price changes (decreases and increases). If the cumulative price changes result in an increase of 5% or more from the reported SPC-2 Price-Performance, the Test Sponsor must submit a revised FDR with the new pricing information to the SPC within 30 days of the effective date of the price changes to remain compliant. Pricing changes below the 5% increase threshold are submitted at the discretion of the Test Sponsor. In either case, the benchmark need not be rerun to remain compliant if there are no changes in the Priced Storage Configuration resulting from the revised pricing.

***Comment:** The intent of this clause is that published SPC-2 Price-Performance reflects actual current SPC-2 Price-Performance.*

2. The original Availability Date for the Priced Storage Configuration may be revised consistent with the Availability requirement specified in Clause 9.2.2.5. The benchmark need not be rerun to remain compliant if there are no changes in the Priced Storage Configuration resulting from the revised Availability Date.

Requirements for pricing and/or Availability Date revisions that would result in changes to an existing Priced Storage Configuration are addressed in Clause 10.8.

Revisions to FDRs may be required for other reasons specified in the SPC Policies and Procedures.

10.5 Component Substitution in a revised Full Disclosure Report.

If a revision to an existing SPC-2 Full Disclosure Report would result in a change to the Priced Storage Configuration documented in the existing FDR, the Test Sponsor must submit for review by the auditor, a list of components that would be changed. The auditor may require additional information and/or specific tests to be executed to ensure the new Priced Storage Configuration is capable of successfully completing the Persistence Test, as well as, providing at least the same level of reported performance as stated in the current FDR.

Examples of component substitutions include:

- Replacement of an obsolete component that was included in the existing Priced Storage Configuration.
- Replacement of a component when a change in the component's availability would extend the SPC-2 Availability Date beyond the period allowed by the specification (Clause 9.2.2.5).

If the Priced Storage Configuration component changes are approved by the auditor, an amended Audit Report will be issued to the Test Sponsor for inclusion in the revised FDR. If the auditor does not approve the component changes, the Test Sponsor may appeal that decision to the Compliance Review Committee (CRC).

10.6 Full Disclosure Report Content

Clauses 10.6.1 – 10.6.11 describe the required content of the FDR. The FDR content will follow that same order as the above clauses and organized under a hierarchy of headings that correspond to those clauses.

10.6.1 Title Page

The Title Page of the FDR will only contain the following information:

- Title: "SPC-2 Benchmark Full Disclosure Report"
- The applicable SPC-2 Benchmark Specification version
- The Test Sponsor's name, corporate website URL, and, optionally, a company logo
- The formal Tested Storage Product (TSP) name.
- The "Submitted for Review" notation and date, which designates the submission as a SPC-2 benchmark result and the start of the 60-day Peer Review.
- The SPC-2 Submission Identifier assigned to the SPC-2 benchmark result.

When a SPC-2 benchmark result successfully completes the required 60-day Peer Review (see Clause), the Title Page of its FDR may be updated with the following information:

- The "Accepted" notation and date that the SPC-2 benchmark result successfully completed its 60-day Peer review and transitioned from "Submitted for Review" to "Accepted".
- The SPC-2 certified logo.

10.6.2 Table of Contents

The Table of Contents will identify the location of each 1st and 2nd level heading in the FDR.

10.6.3 Audit Certification

This section of the FDR shall contain a copy of the certification letter issued by the SPC Audit Service to the Test Sponsor for this execution of the SPC-2 Benchmark. If the FDR is a revision to an existing FDR and contains changes to the original Priced Storage Configuration, the revised FDR shall contain an amended certification letter that includes auditor review and approval of those changes.

10.6.4 Letter of Good Faith

This section of the FDR shall contain a copy of the Letter of Good Faith issued by the Test Sponsor to the SPC Audit Service for this execution of the SPC-2 Benchmark. The Letter of Good Faith is required to be identical in format and content to the template in Appendix A on page 143 with the appropriate changes specific to the benchmark submission (Test Sponsor name, TSC name, date, etc.). Any other changes in content and format must be approved by the SPC Compliance Review Committee (CRC) prior to the benchmark submission.

10.6.5 Executive Summary

The Executive Summary will consist of the content described in Clauses 10.6.5.1 –10.6.6.3.

10.6.5.1 Contact Information

This table will contain contact information for the Test Sponsor, Co-Sponsors, and the SPC Auditor. The required content and format of the table is specified in Table 10-8.

Test Sponsor and Contact Information	
Test Sponsor Primary Contact (1)	Company, Company Web Address, Individual Name – Email Address Postal Address Phone, FAX
Test Sponsor Alternate Contact (2)	Company, Company Web Address, Individual Name – Email Address Postal Address Phone, FAX
Auditor (3)	Company, Company Web Address, Individual Name – Email Address Postal Address Phone, FAX

Table 10-8: Test Sponsor and Contact Information

Footnotes to Table 10-8:

1. *The Test Sponsor contact responsible for the submitted FDR. The primary Test Sponsor contact will be the first point of contact for any issues that may arise during the Peer Review Process.*
2. *The alternate Test Sponsor contact to be contacted only if the primary contact is not available.*
3. *Contact information for the Auditor used to certify the SPC-2 results.*

10.6.5.2 Revision Information and Key Dates

This table will contain key dates and revision numbers associated with the SPC-2 result. The required content and format of the table is specified in Table 10-9.

Where appropriate in both the Executive Summary and Full Disclosure Report, the revised details will be highlighted. For example, highlight pricing line items that have been revised.

Table 10-9: Revision Information and Key Dates

Revision Information and Key Dates	
SPC-2 Specification revision number (1)	nn.nn.nn
SPC-2 Workload Generator revision number (2)	nn.nn.nn
Date Results were first used publicly (3)	mmmm dd, yyyy
Date FDR was submitted to the SPC (4)	mmmm dd, yyyy
Date revised FDR was submitted to the SPC (5) Current revision text: Revision History: dd/mm/yyyy – revision text dd/mm/yyyy – revision text	mmmm dd, yyyy
Price Storage Configuration Availability Date (6)	mmmm dd, yyyy
Date the TSC completed audit certification (7)	mmmm dd, yyyy

Footnotes to Table 10-9:

- 1. The revision number of the SPC-2 Specification used to produce the results reported in this FDR.*
- 2. The revision number of the Workload Generator used to produce the results reported in this FDR.*
- 3. The calendar date that the results reported in this FDR were made public (i.e., used outside the Test Sponsors and Co-Sponsors companies).*
- 4. The calendar date that the results reported in this FDR were submitted to the SPC.*
- 5. The calendar date that a revised FDR was submitted to the SPC. The Revision History is a brief description of each revision.*
- 6. The Priced Storage Configuration Availability Date defined in Clause 10.6.10.*
- 7. The calendar date that the SPC-2 Audit was successfully completed as documented by the Audit Certification Letter issued to the Test Sponsor.*

10.6.5.3 Tested Storage Product (TSP) Description

The executive summary shall contain a brief description of the Tested Storage Product (TSP).

Features used in the benchmark by the TSP may be included in the description. Features available in the TSP, but not used in the benchmark cannot be included in the description.

The description may include a website link to official product information available from the Test Sponsor.

10.6.5.4 Reported Data

This table will contain SPC-2 reported data described in Clause 8: Reported Data, which are associated with the SPC-2 result. The required content and format of the table is specified in Table 10-10.

Table 10-10: SPC-2 Reported Data

SPC-2 Reported Data				
Priced Storage Configuration Name: xxxxxxxxxxxxxxxxxxxx (1)				
SPC-2 MBPS™	SPC-2 Price-Performance	Total Price	ASU Capacity	Data Protection Level
(2)	(3)	(4)	(5)	(6)
The above SPC-2 MBPS™ value represents the aggregate data rate of all three SPC-2 workloads: Large File Processing (LFP), Large Database Query (LDQ), and Video On Demand (VOD).				
Currency Used:		Target Country:		
(7)		(8)		
SPC-2 Large File Processing (LFP) Reported Data				
	Data Rate	Number of Streams	Data Rate per Stream	Price-Performance
LFP Composite	(9)			(10)
Write Only:				
1024 KiB Transfer	(11)	(12)	(13)	
256 KiB Transfer	(14)	(15)	(16)	
Read-Write:				
1024 KiB Transfer	(17)	(18)	(19)	
256 KiB Transfer	(20)	(21)	(22)	
Read Only:				
1024 KiB Transfer	(23)	(24)	(25)	
256 KiB Transfer	(26)	(27)	(28)	
The above SPC-2 Data Rate value for LFP Composite represents the aggregate performance of all three LFP Test Phases: (Write Only, Read-Write, and Read Only).				
SPC-2 Large Database Query (LDQ) Reported Data				
	Data Rate	Number of Streams	Data Rate per Stream	Price-Performance
LDQ Composite	(29)			(30)
1024 KiB Transfer Size:				
4 I/Os Outstanding	(31)	(32)	(33)	
1 I/O Outstanding	(34)	(35)	(36)	
64 KiB Transfer Size:				
4 I/Os Outstanding	(37)	(38)	(39)	
1 I/O Outstanding	(40)	(41)	(42)	
The above SPC-2 Data Rate value for LDQ Composite represents the aggregate performance of the two LDQ Test Phases: (1024 KiB and 64 KiB Transfer Sizes).				
SPC-2 Video On Demand (VOD) Reported Data				
	Data Rate	Number of Streams	Data Rate per Stream	Price-Performance
	(43)	(44)	(45)	(46)

Footnotes to Table 10-10:

1. The formal name of the Tested Storage Product as defined in Clause 4.6.
2. Defined in Clause 8.2.1.1.
3. Defined in Clause 8.2.2.1.
4. Defined in Clause 9.1.6.

5. *Defined in Clause 2.6.5 and must be stated in gigabytes (GB) as a value with three digits of precision to the right of the decimal point.*
6. *The Data Protection Level that was selected per Clause 2.7. A brief description of the data protection must be included in the Executive Summary.*
7. *Formal name of the currency used in the Priced Storage Configuration pricing.*
8. *If non-local currency (Clause 9.2.4.2) was used, the name of the “target country” (Clause 9.2.3).*
9. *Defined in Clause 8.5.2.1.1*
10. *Defined in Clause 8.5.2.2.1.*
11. *The data rate reported for LFP Test Sequence 1: WRITE ONLY, 1024 KiB Transfer Size.*
12. *The number of Streams specified to generate the data rate reported in #9.*
13. *The ratio of the data rate reported in #9 to the number of Streams specified in #10.*
14. *The data rate reported for LFP Test Sequence 2: WRITE ONLY, 256 KiB Transfer Size.*
15. *The number of Streams specified to generate the data rate reported in #12.*
16. *The ratio of the data rate reported in #12 to the number of Streams specified in #13.*
17. *The data rate reported for LFP Test Sequence 3: READ-WRITE, 1024 KiB Transfer Size.*
18. *The number of Streams to generate the data rate reported in #15.*
19. *The ratio of the data rate reported in #15 to the number of Streams specified in #16.*
20. *The data rate reported for LFP Test Sequence 4: READ-WRITE, 256 KiB Transfer Size.*
21. *The number of Streams specified to generate the data rate reported in #18.*
22. *The ratio of the data rate reported in #18 to the number of Streams specified in #19.*
23. *The data rate reported for LFP Test Sequence 5: READ-ONLY, 1024 KiB Transfer Size.*
24. *The number of Streams specified to generate the data rate reported in #21.*
25. *The ratio of the data rate reported in #21 to the number of Streams specified in #22.*
26. *The data rate reported for LFP Test Sequence 6: READ-ONLY, 256 KiB Transfer Size.*
27. *The number of Streams specified to generate the data rate reported in #24.*
28. *The ratio of the data rate reported in #24 to the number of Streams specified in #25.*
29. *Defined in Clause 8.5.4.1.1.*
30. *Defined in Clause 8.5.4.2.1*
31. *The data rate reported for LDQ Test Sequence 1: 1024 KIB TRANSFER SIZE, 4 Outstanding I/Os.*

32. *The number of Streams specified to generate the data rate reported in #29.*
33. *The ratio of the data rate reported in #29 to the number of Streams specified in #30.*
34. *The data rate reported for LDQ Test Sequence 2: 1024 KIB TRANSFER SIZE, 1 Outstanding I/O.*
35. *The number of Streams specified to generate the data rate reported in #32.*
36. *The ratio of the data rate reported in #32 to the number of Streams specified in #33.*
37. *The data rate reported for LDQ Test Sequence 3: 64 KIB TRANSFER SIZE, 4 Outstanding I/Os.*
38. *The number of Streams specified to generate the data rate reported in #35.*
39. *The ratio of the data rate reported in #35 to the number of Streams specified in #36.*
40. *The data rate reported for LDQ Test Sequence 4: 64 KIB TRANSFER SIZE, 1 Outstanding I/O.*
41. *The number of Streams specified to generate the data rate reported in #38.*
42. *The ratio of the data rate reported in #38 to the number of Streams specified in #39.*
43. *Defined in Clause 8.5.5.1.1.*
44. *Defined in Clause 8.5.5.2.1.*
45. *Defined in Clause 8.5.5.3.1.*
46. *Defined in Clause 8.5.5.4.1.*

10.6.5.5 Pricing

The Executive Summary will contain a pricing spreadsheet as described in Clause 9.3.1.

10.6.5.6 Discounts

The Executive Summary shall describe the basis, including type and justification, of any discounts (*Clause 9.3.1.5*) included in the pricing spreadsheet.

10.6.5.7 Tested Storage Configuration and Priced Storage Configuration Differences

The Executive Summary will contain a list of all differences between the Tested Storage Configuration (TSC) and Priced Storage Configuration. Those differences will include substituted components (hardware and software), cosmetic changes to physical packaging, component identification responses, and other miscellaneous differences.

See Clauses 9.1.1 and 9.1.2 for definitions of TSC and Priced Storage Configuration.

10.6.5.7.1 Republished SPC-2 Result

If a new SPC-1 benchmark result republishes an existing SPC-1 Result, all hardware and/or software differences between the original and new Priced Tested Storage Configurations must be listed. Component substitution between the TSC and Priced Storage Configuration, which would impact the existing SPC-1 Result's reported performance, is not allowed.

See Clause 10.6.11 for the requirements for audit reuse.

10.6.5.7.2 OEM 1/OEM 2 SPC-2 Result

An OEM 1/OEM 2 SPC-2 Result is created when one SPC member company (OEM 1) produces an audited set of SPC-2 measurements that are used by another SPC member company (OEM 2) to become a new SPC-2 Result. The audited measurement will not be used by OEM 1 to produce an SPC-2 Result.

Component substitution between the TSC and Priced Storage Configuration, which would impact the existing SPC-1 Result's reported performance, is not allowed.

10.6.5.8 Revisions to an existing Executive Summary –Priced Storage Configuration Component Changes

Revisions to an existing Executive Summary will contain a list of all Priced Storage Configuration component changes that result from the pricing and/or availability date changes. The list shall contain the name of the original component, the new component, and a brief description of the difference(s) between the two components. The components list must be identical to the components listed in the revised Audit Certification (Clause 10.6.3)

10.6.5.9 Priced Storage Configuration Diagram

The Executive Summary will contain a high-level diagram of the Priced Storage Configuration, which illustrates the major components of the configuration.

10.6.5.10 Priced Storage Configuration Table of Components

The Executive Summary will contain a table that lists the major components of the Priced Storage Configuration (TSC). Table 10-11 specifies the content, format, and appearance of the table.

Table 10-11: Priced Storage Configuration Components

Priced Storage Configuration:
Host Bus Adapter (HBA) information (1)
TSP formal product name (2)
Storage/Domain Controller information (3)
Storage device information (4)
All other major configuration components (5) (e.g. switches, enclosures, etc.)

Footnotes to Table 10-11:

1. The number, product/model name and description of all Host Bus Adapters installed on each Host System
2. The Tested Storage Product's formal product name and model.
3. The model/name and description of each storage/domain controller in the priced storage configuration. The description will include:
 - The amount of memory and cache.
 - The type and total number of front-end physical connections.
 - The type and total number of back-end physical connections.

- The number of configured Storage Devices (6) accessible by the storage/domain controller.
4. The number of Storage Devices in the priced storage configuration and a description of each type of Storage Device. The description will include:
 - The type of device (disk drive, solid state device, etc.).
 - The formatted capacity of each Storage Device type.
 - The rotation speed, if appropriate, of each Storage Device type.
 5. All other major TSC components such as switches, enclosures, etc.

Note: This clause concludes the Executive Summary portion of the Full Disclosure Report.

10.6.6 Benchmark Configuration (BC)/Tested Storage Configuration (TSC) Diagram

The FDR will contain a one page BC/TSC diagram that illustrates all major components of the BC/TSC. An example of the required diagram is illustrated in Figure 10-10.

Figure 10-10: Benchmark Configuration/Tested Storage Configuration Diagram

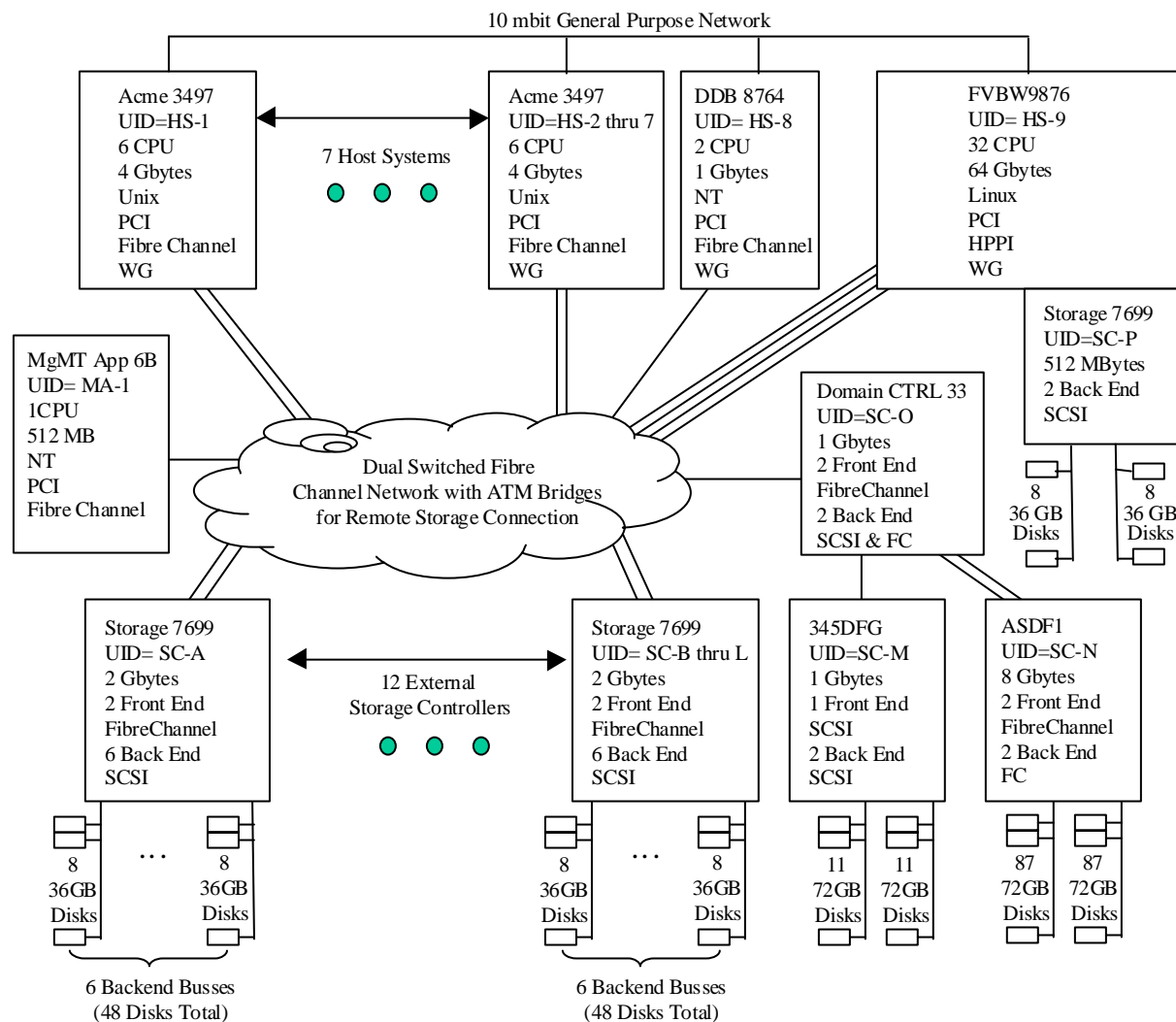

Examples of the major components that must be included in the diagram include:

1. All Host Systems and Management Appliances in the BC. Each Host System and Management Appliance contained in the diagram will include the following information:
 - CPU information that includes number of CPUs, model of each CPU, clock speed of each CPU, and cache configuration for each CPU.
 - The amount of main memory configured.
 - The operating system and version.
 - The type of system I/O interconnect.

- The type of physical connections between adapters that are connected to the system I/O interconnect and any storage controllers, domain controllers, or storage devices.
2. All storage controllers and domain controllers in the TSC. Each storage controller and domain controller contained in the diagram will include the following information:
 - The model and/or name.
 - The amount of memory and cache.
 - The number of front-end physical connections and the type of each front-end connection.
 - The number of back-end physical connections and the type of each back-end connection.
 - The type of physical connections between adapters that are connected to the system I/O interconnect and the storage controller or domain controller.
 3. The number of storage devices and their individual formatted storage capacities.
 4. If the TSC contains network storage, the diagram will include the network configuration. If a single diagram is not sufficient to illustrate both the Benchmark Configuration and network configuration in sufficient detail, the Benchmark Configuration diagram will include a high-level network illustration as shown in Figure 10-10. In that case, a separate, detailed network configuration diagram will also be included as described in Clause 10.6.6.1.

***Comment:** Configurations vary widely and it is impossible to provide exact guidelines suitable for all configurations. The intent of this clause is to describe the system components and connections in sufficient detail to allow independent reconstruction of the BC environment.*

10.6.6.1 Storage Network Configuration Diagram

If a storage network was configured as a part of the Tested Storage Configuration and the Benchmark Configuration diagram described in Clause 10.6.5.8 contains a high-level illustration of the network configuration, the Executive Summary will contain a one page topology diagram of the storage network as illustrated in Figure 10-11.

Figure 10-11: Storage Network Configuration Diagram

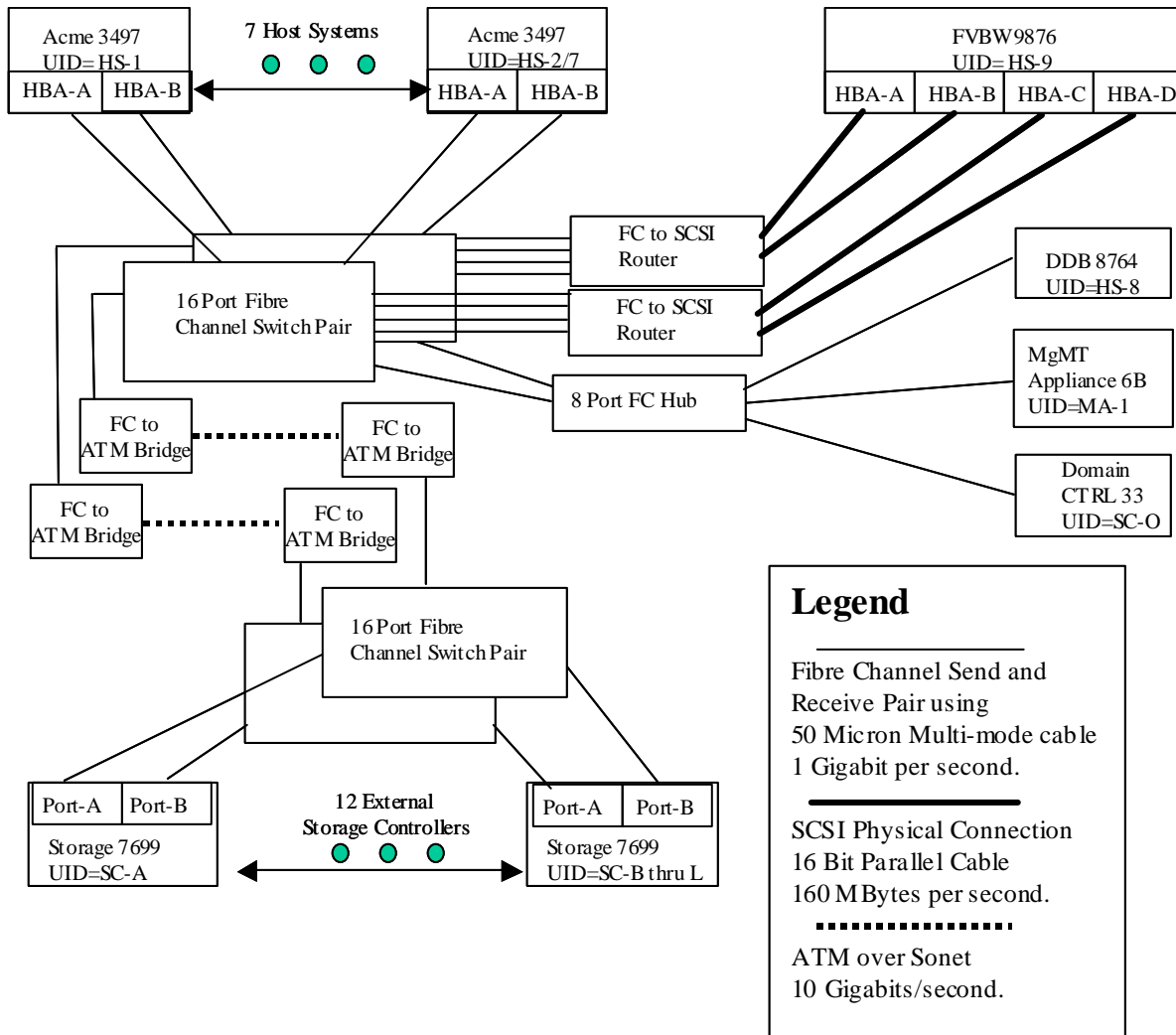

The diagram should include, but is not limited to the following components:

1. Storage controllers and domain controllers (see Clause 10.6.5.9)
2. Host Systems (see Clause 10.6.5.9)
3. Routers and bridges
4. Hubs and switches
5. Host Bus Adapters (HBAs) to Host Systems connections
6. Front-end port to storage controller and/or domain controller connections.

Additionally the diagram shall:

- Illustrate the physical connection between components.
- Describe the type of each physical connection.
- Describe the network protocol used over each physical connection.

- The maximum theoretical transfer rate of each class of interconnect used in the configuration.
- Correlate with the BC Configuration Diagram in Clause 10.6.5.9.

Comment: *The intent of this and the preceding clause is to provide enough detailed configuration information, along with other FDR information, to independently recreate the benchmark configuration and obtain the results published by the Test Sponsor.*

10.6.6.2 Host System and Tested Storage Configuration (TSC) Table

The Executive Summary will contain a table that lists the major components of each Host System and the Tested Storage Configuration (TSC). Table 10-12 specifies the content, format, and appearance of the table.

Table 10-12: Host System(s) and Tested Storage Configuration

Host System	Tested Storage Configuration (TSC)
Host System name/model (1)	Host Bus Adapter (HBA) information (6)
CPU Information (2)	TSC Product Name (7)
Main Memory configuration (3)	Storage/Domain Controller information (8)
Operating system name and version (4)	Front-end interconnection information (9)
TSC software (5)	Back-end interconnection information (10)
	Storage device information (11)
	All other major TSC components (12) (e.g., switches, enclosures, etc.)

Footnotes to Table 10-12:

1. The product name and model of each Host System used in the benchmark.
2. The number, product/model name, and description of the CPUs in each Host System. The description will include clock speed.
3. The amount of main memory configured in each Host System.
4. The operating system, version, and any specific patches/updates installed on each Host System.
5. Any software, other than the operating system, installed on the Host System that provided TSC functionality such as a volume manager.
6. The number, product/model name and description of all Host Bus Adapters installed on each Host System.
7. The Tested Storage Configuration's product name and model.
8. The model/name and description of each storage/domain controller in the TSC. The description will include:

- The amount of memory and cache.
 - The type and total number of front-end physical connections.
 - The type and total number of back-end physical connections.
 - The type of physical connection between the Host System and storage/domain controller
 - The number of configured Storage Devices (12) accessible by the storage/domain controller.
9. The number of physical front-end connections used in the benchmark.
 10. The number of physical back-end physical connections used in the benchmark and the number of Storage Devices accessible by each connection.
 11. The number of Storage Devices in the TSC and a description of each type of Storage Device. The description will include:
 - The type of device (disk drive, solid state device, etc.).
 - The formatted capacity of each Storage Device type.
 - The rotation speed, if appropriate, of each Storage Device type.
 - The amount of cache in each Storage Device type.
 12. All other major TSC components such as switches, enclosures, etc.

10.6.6.3 Configuration Differences in a Republished Full Disclosure Report

If the Full Disclosure Report is submitted to republish an existing SPC-2 benchmark result, all hardware and/or software differences between the original and new Priced Tested Storage Configurations must be listed in the Executive Summary. In addition, the performance impact of each difference must be listed. See Clause 11.5 for the requirements for republishing an existing SPC-2 benchmark.

10.6.7 Benchmark Configuration – Tested Storage Configuration

The intent of Clauses 10.6.7.1 –10.6.7.3 is to require disclosure of the detailed information necessary to recreate the Benchmark Configuration, including the Tested Storage Configuration, so that the SPC-2 benchmark results submitted by the Test Sponsor may be independently reproduced.

10.6.7.1 Customer Tuning Parameters and Options

All Benchmark Configuration (BC) components with customer tunable parameters and options that have been altered from their default values must be listed in the Full Disclosure Report (FDR). The FDR entry for each of those components must include both the name of the component and the altered value of the parameter or option. If the parameter name is not self-explanatory to a knowledgeable practitioner, a brief description of the parameter’s use must also be included in the FDR entry.

Examples of customer tunable parameters and options include:

- Options for each component used in a network used to connect TSC component to Host Systems.
- Host Bus Adapter Options.
- Storage controller and domain controller options.
- Operating system, run time environment, and application configuration parameters.
- Compilation and linkage options and run-time optimizations used to create/install any applications or the OS used on the BC.

10.6.7.2 Tested Storage Configuration Creation and Configuration

The Full Disclosure Report must include sufficient information to recreate the logical representation of the Tested Storage Configuration (TSC). In addition to customer tunable parameters and options (Clause 10.6.7.1), that information must include, at a minimum:

- A diagram and/or description of the following:
 - All physical components that comprise the TSC. Those components are also illustrated in the BC Configuration Diagram in Clause 10.6.6.1 and the Storage Network Configuration Diagram in Clause 10.6.6.1.
 - The logical representation of the TSC, configured from the above components that will be presented to the SPC-2 Workload Generator.
- Listings of scripts used to create the logical representation of the TSC.
- If scripts were not used, a description of the process used with sufficient detail to recreate the logical representation of the TSC.

10.6.7.3 SPC-2 Workload Generator Storage Configuration

The Full Disclosure Report will include all SPC-2 Workload Generator storage configuration commands and parameter used in the SPC-2 benchmark measurement.

10.6.8 Data Repository

The intent of Clauses 10.6.8.1 – 0 is to require disclosure of the detailed information that fully describes and accounts for the various storage capacities and mappings used in Tested Storage Configuration.

10.6.8.1 SPC-2 Storage Capacities and Relationships

Two tables and four charts documenting the storage capacities and relationships of the SPC-2 Storage Hierarchy (Clause 2.1) will be included in the FDR. The content, appearance, and format of the tables are specified in Table 10-13 and Table 10-14. The content, appearance, and format of the charts are specified in Figure 10-12– Figure 10-15.

In addition, an annotation must be included with the table illustrated in Table 10-13 that documents the source of the value presented for Physical Storage Capacity. The source will be either formatted capacity or capacity reported as available for application use. If multiple Storage Device models are included in the Tested Storage Configuration, the annotation must detail the appropriate source for each model.

The annotation must also include the following text:

“The configured Storage Devices may include additional storage capacity reserved for system overhead, which is not accessible for application use. That storage capacity may not be included in the value presented for Physical Storage Capacity”.

Table 10-13: SPC-2 Storage Capacities

SPC-2 Storage Capacities		
Storage Hierarchy Component	Units	Capacity
ASU Capacity (1)	GB	nnn,nnn.nn
Addressable Storage Capacity (2)	GB	n,nnn,nnn.nn
Configured Storage Capacity (3)	GB	n,nnn,nnn.nn
Physical Storage Capacity (4)	GB	n,nnn,nnn.nn
Data Protection Capacity (5)	GB	nnn,nnn.nn
Required Storage (6)	GB	nnn,nnn.nn
Global Storage Overhead (7)	GB	nn.nn
Total Unused Storage (8)	GB	nn.nn

Footnotes to Table 10-13.

1. *Defined in Clause 2.6*
2. *Defined in Clause 2.4*
3. *Defined in Clause 2.3*
4. *Defined in Clause 2.2*
5. *Defined in Clause 2.7.3*
6. *Defined in Clause 2.3.2*
7. *Defined in Clause 2.2.3*
8. *Sum of capacities defined in Clauses 2.2.4, 2.3.2, and 2.4.3.*

Capacities must be stated in gigabytes (GB) as a value with a minimum of two digits to the right of the decimal point.

Table 10-14: SPC-2 Storage Hierarchy Ratios

	Addressable Storage Capacity	Configured Storage Capacity	Physical Storage Capacity
Total ASU Capacity	(1)	(2)	(3)
Data Protection Capacity		(4)	(5)
Addressable Storage Capacity		(8)	(9)
Required Storage/Spares		(10)	(11)
Configured Storage Capacity			(12)
Global Storage Overhead			(13)
Unused Storage	(14)	(15)	(16)

Footnotes to

Table 10-14.

The values calculated below are to be represented as a percentage with two significant digits, truncating after the second significant digit.

- 1. Total ASU Capacity ÷ Addressable Storage Capacity*
- 2. Total ASU Capacity ÷ Configured Storage Capacity*
- 3. Total ASU Capacity ÷ Physical Storage Capacity*
- 4. Data Protection Capacity ÷ Configured Storage Capacity*
- 5. Data Protection Capacity ÷ Physical Storage Capacity*
- 6. Addressable Storage Capacity ÷ Configured Storage Capacity*
- 7. Addressable Storage Capacity ÷ Physical Storage Capacity*
- 8. Required Storage ÷ Configured Storage Capacity*
- 9. Required Storage ÷ Physical Storage Capacity*
- 10. Configured Storage Capacity ÷ Physical Storage Capacity*
- 11. Global Storage Overhead ÷ Physical Storage Capacity*
- 12. Unused Storage (contained in Addressable Storage Capacity) ÷ Addressable Storage Capacity*
- 13. Unused Storage (contained in Configured Storage Capacity) ÷ Configured Storage Capacity*
- 14. Unused Storage (total) ÷ Physical Storage Capacity*

Figure 10-12: SPC-2 Physical Storage Capacity

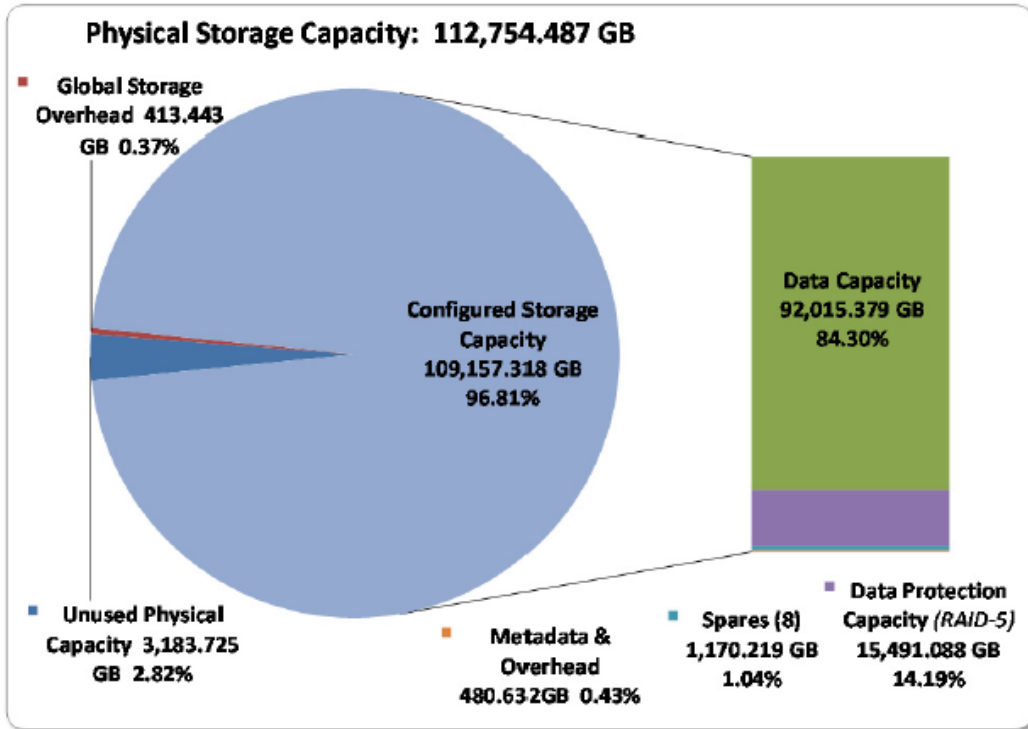

Figure 10-13: SPC-2 Configured Storage Capacity

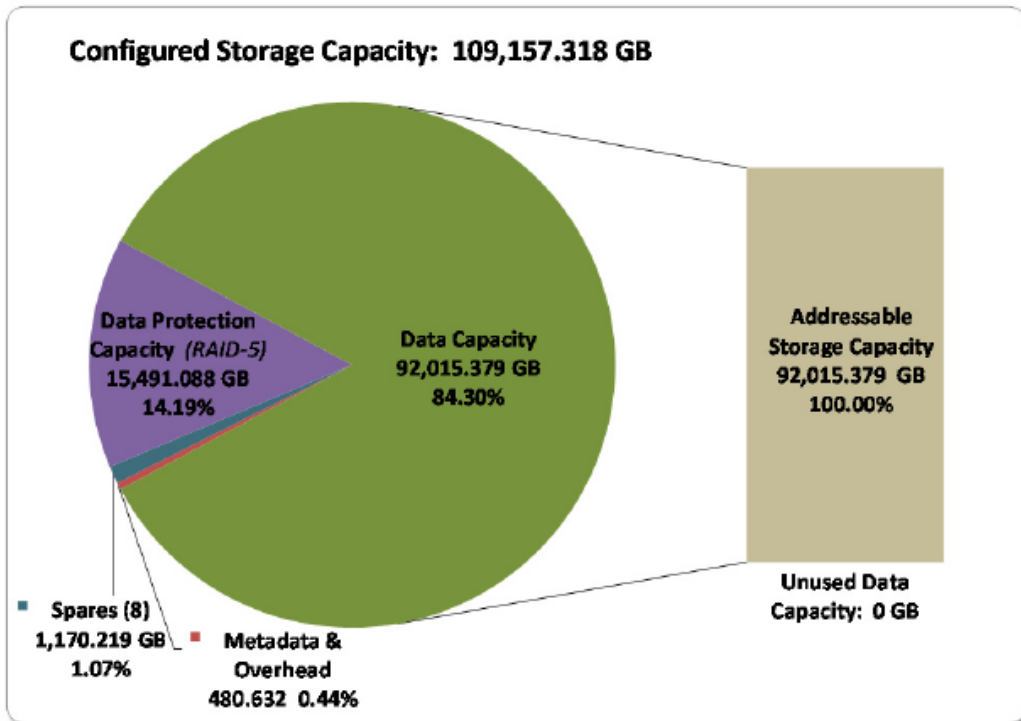

Figure 10-14 SPC-2 Addressable Storage Capacity

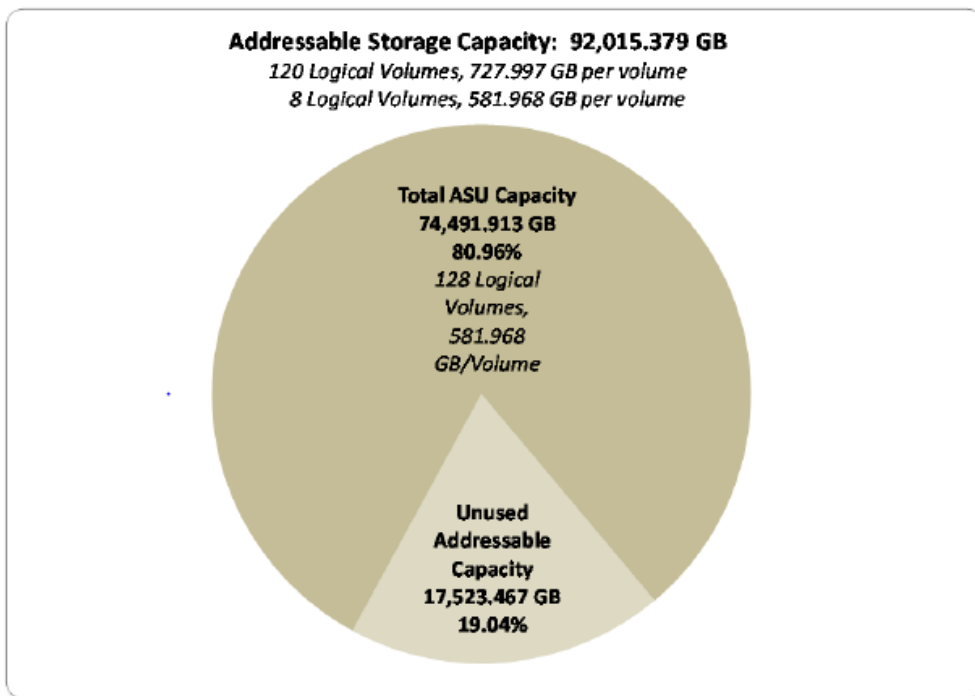
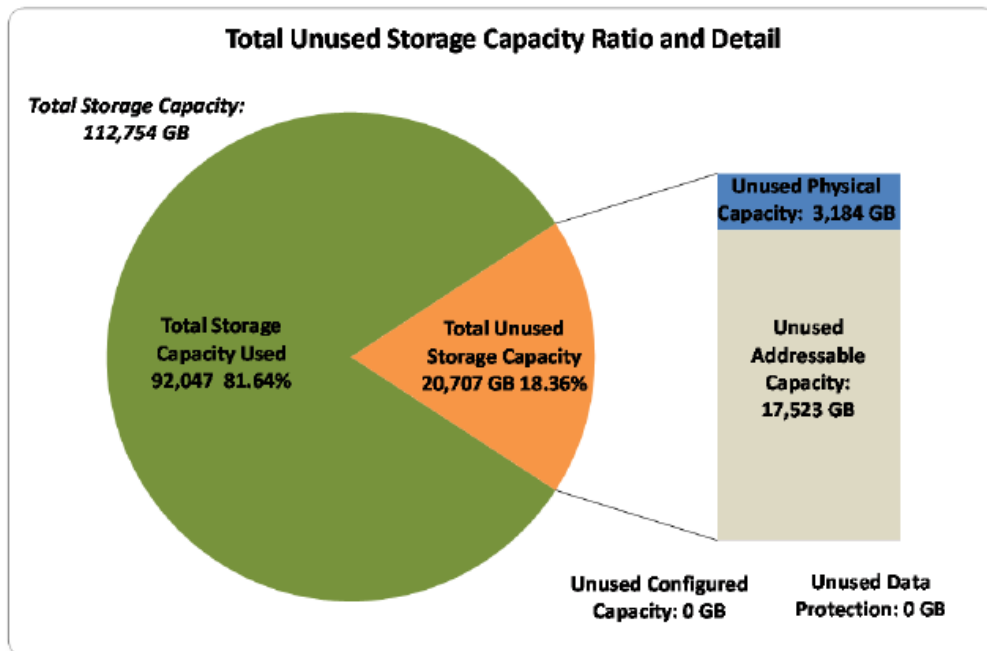

Figure 10-15 SPC-2 Total Unused Storage Capacity Ratio and Detail



10.6.8.2 Storage Capacity Utilization

The FDR will include a table illustrating the storage capacity utilization values defined for Application Utilization (Clause 2.8.1), Protected Application Utilization (Clause 2.8.2), and Unused Storage Ratio (Clause 2.8.3). The content, appearance, and format of this table are specified in Table 10-15.

Table 10-15: SPC-2 Capacity Utilization

SPC-2 Storage Capacity Utilization	
Application Utilization (1)	%
Protected Application Utilization (2)	%
Unused Storage Ratio (3)	%

Footnotes to Table 10-15.

- 1. Total ASU Capacity divided by Physical Storage Capacity (Clause 2.8.1).*
- 2. (Total ASU Capacity plus total Data Protection Capacity minus unused Data Protection Capacity) divided by Physical Storage Capacity (Clause 2.8.2).*
- 3. Total Unused Capacity divided by Physical Storage Capacity (Clause 2.8.3).*

10.6.8.3 Logical Volume Capacities and Application Storage Unit Mapping

A table illustrating the capacity of the Application Storage Unit (ASU) and the mapping of Logical Volumes to ASU will be provided in the FDR. Capacity must be stated in gigabytes (GB) as a value with a minimum of two digits to the right of the decimal point. Each Logical Volume will be sequenced in the table from top to bottom per its position in the contiguous address space of the ASU. Each Logical Volume entry will list its total capacity, the portion of that capacity used for the ASU, and any unused capacity. The content, appearance, and format of this table are specified in Table 10-16.

Table 10-16: SPC-2 Capacity Utilization

Logical Volume Capacity and Mapping			
ASU (nnn,nnn.nn GB)			
	Total Capacity (GB)	Capacity Used (GB)	Capacity Unused (GB)
Logical Volume 1	nnn.nn	nnn.nn	nnn.nn
Logical Volume 2	nnn.nn	nnn.nn	nnn.nn
Logical Volume 3	nnn.nn	nnn.nn	nnn.nn
Logical Volume n	nnn.nn	nnn.nn	nnn.nn

10.6.9 SPC-2 Test Execution Results

Clauses 10.6.8.1– 10.6.8.4 describe the required content and format of the Full Disclosure Report section that documents the results of the various SPC-2 Tests, Test Phases, and Test Runs.

10.6.9.1 Large File Processing Test

The Full Disclosure Report will contain the following content for the Large File Processing Test:

1. A listing of the SPC-2 Workload Generator commands and parameters used to execute each of the Test Runs in the Large File Processing Test.
2. The human readable SPC-2 Test Results File for each of the Test Runs in the Large File Processing Test.
3. The following three tables, defined in Clauses 10.1.1– 10.1.3 are:
 - Average Data Rate: This table will contain the average Data Rate, in MB per second, for the Measurement Interval of each Test Run in the Large File Processing Test.
 - Average Data Rate per Stream: This table will contain the average Data Rate per Stream, in MB per second, for the Measurement Interval of each Test Run in the Large File Processing Test.
 - Average Response Time: This table will contain the average Response Time, in milliseconds (ms), for the Measurement Interval of each Test Run in the Large File Processing Test.

Each table will also include the following information for each Test Run:

- The number Streams specified.
- The Ramp-Up duration in seconds.
- The Measurement Interval duration in seconds.

Table 10-1, Table 10-2, and Table 10-3 illustrate the required content, format, and appearance of the three required tables.

4. Average Data Rate, Average Data Rate per Stream, and Average Response Time graphs as defined in Clauses 10.1.1, 10.1.2, and 10.1.3. Figure 10-1, Figure 10-2, and Figure 10-3 illustrate the required content, format, and appearance of the three required graphs.

10.6.9.1.1 Large File Processing Test – WRITE ONLY Test Phase

1. A table that will contain the following information, as described in Clauses 10.1.4 – 10.1.6, for each "WRITE ONLY, 1024 KiB Transfer Size" Test Run:
 - The number of Streams specified.
 - The average Data Rate (10.1.4), average Data Rate per Stream (10.1.5), and average Response Time (10.1.6) reported at five second intervals.

Table 10-4 illustrates the required content, format, and appearance of the table.

2. Average Data Rate by Intervals, Average Data Rate per Stream by Intervals, and Average Response Time by Intervals graphs for the "WRITE ONLY, 1024 KiB Transfer Size" Test Runs as specified in Clauses 10.1.4 – 10.1.6. Figure 10-4 – Figure 10-6 illustrate the required content, format, and appearance of the three required graphs.

3. A table that will contain the following information, as described in Clauses 10.1.4 – 10.1.6, for each “WRITE ONLY, 256 KiB Transfer Size” Test Run:
 - The number of Streams specified.
 - The average Data Rate (10.1.4), average Data Rate per Stream (10.1.5), and average Response Time (10.1.6) reported at five second intervals.

Table 10-4 illustrates the required content, format, and appearance of the table.

4. Average Data Rate by Intervals, Average Data Rate per Stream by Intervals, and Average Response Time by Intervals graphs for the “WRITE ONLY, 256 KiB Transfer Size” Test Runs as specified in Clauses 10.1.4 - 10.1.6. Figure 10-4 – Figure 10-6 illustrate the required content, format, and appearance of the three required graphs.

A hyperlink for each of the above tables and graphs may appear in the FDR to provide access to the table or graph.

10.6.9.1.2 Large File Processing Test – READ-WRITE Test Phase

1. A table that will contain the following information, as described in Clauses 10.1.4 – 10.1.6, for each “READ-WRITE, 1024 KiB Transfer Size” Test Run:
 - The number of Streams specified.
 - The average Data Rate (10.1.4), average Data Rate per Stream (10.1.5), and average Response Time (10.1.6) reported at five second intervals.

Table 10-4 illustrates the required content, format, and appearance of the table.

3. Average Data Rate by Intervals, Average Data Rate per Stream by Intervals, and Average Response Time by Intervals graphs for the “READ-WRITE, 1024 KiB Transfer Size” Test Runs as specified in Clauses 10.1.4 – 10.1.6. Figure 10-4 – Figure 10-6 illustrate the required content, format, and appearance of the three required graphs.

3. A table that will contain the following information, as described in Clauses 10.1.4 – 10.1.6, for each “READ-WRITE, 256 KiB Transfer Size” Test Run:
 - The number of Streams specified.
 - The average Data Rate (10.1.4), average Data Rate per Stream (10.1.5), and average Response Time (10.1.6) reported at five second intervals.

Table 10-4 illustrates the required content, format, and appearance of the table.

4. Average Data Rate by Intervals, Average Data Rate per Stream by Intervals, and Average Response Time by Intervals graphs for the “READ-WRITE, 256 KiB Transfer Size” Test Runs as specified in Clauses 10.1.4 – 10.1.6. Figure 10-4 – Figure 10-6 illustrate the required content, format, and appearance of the three required graphs.

A hyperlink for each of the above tables and graphs may appear in the FDR to provide access to the table or graph.

10.6.9.1.3 Large File Processing Test – READ ONLY Test Phase

1. A table that will contain the following information, as described in Clauses 10.1.4 – 10.1.6, for each “READ ONLY, 1024 KiB Transfer Size” Test Run:
 - The number of Streams specified.
 - The average Data Rate (10.1.4), average Data Rate per Stream (10.1.5), and average Response Time (10.1.6) reported at five second intervals.

Table 10-4 illustrates the required content, format, and appearance of the table.

2. Average Data Rate by Intervals, Average Data Rate per Stream by Intervals, and Average Response Time by Intervals graphs for the “READ ONLY, 1024 KiB Transfer Size” Test Runs as specified in Clauses 10.1.4 - 10.1.6. Figure 10-4 – Figure 10-6 illustrate the required content, format, and appearance of the three required graphs.
3. A table that will contain the following information, as described in Clauses 10.1.4 – 10.1.6, for each “READ ONLY, 256 KiB Transfer Size” Test Run:
 - The number of Streams specified.
 - The average Data Rate (10.1.4), average Data Rate per Stream (10.1.5), and average Response Time (10.1.6) reported at five second intervals.

Table 10-4 illustrates the required content, format, and appearance of the table.

4. Average Data Rate by Intervals, Average Data Rate per Stream by Intervals, and Average Response Time by Intervals graphs for the “READ ONLY, 256 KiB Transfer Size” Test Runs as specified in Clauses 10.1.4 -10.1.6. Figure 10-4 – Figure 10-6 illustrate the required content, format, and appearance of the three required graphs.

A hyperlink for each of the above tables and graphs may appear in the FDR to provide access to the table or graph.

10.6.9.2 Large Database Query Test

The Full Disclosure Report will contain the following content for the Large Database Query Test:

1. A listing of the SPC-2 Workload Generator commands and parameters used to execute each of the Test Runs in the Large Database Query Test.
2. The human readable SPC-2 Test Results File for each of the Test Runs in the Large Database Query Test.
3. The following three tables, defined in Clauses 10.1.1– 10.1.3:
 - Average Data Rate: This table will contain the average Data Rate, in MB per second, for the Measurement Interval of each Test Run in the Large Database Query Test.
 - Average Data Rate per Stream: This table will contain the average Data Rate per Stream, in MB per second, for the Measurement Interval of each Test Run in the Large Database Query Test.
 - Average Response Time: This table will contain the average Response Time, in milliseconds (ms), for the Measurement Interval of each Test Run in the Large Database Query Test.

Each table will also include the following information for each Test Run:

- The number of Streams specified.
- The Ramp-Up duration in seconds.
- The Measurement Interval duration in seconds.

Table 10-1, Table 10-2, and Table 10-3 illustrate the required content, format, and appearance of the three required tables.

4. Average Data Rate, Average Data Rate per Stream, and Average Response Time graphs as defined in Clauses 10.1.1, 10.1.2, and 10.1.3. Figure 10-1, Figure 10-2, and Figure 10-3 illustrate the required content, format, and appearance of the three required graphs.

10.6.9.2.1 Large Database Query Test – 1024 KIB TRANSFER SIZE Test Phase

1. A table that will contain the following information, as described in Clauses 10.1.4 - 10.1.6, for each “1024 KIB TRANSFER SIZE, 4 Outstanding I/Os” Test Run:
 - The number of Streams specified.
 - The average Data Rate (10.1.4), average Data Rate per Stream (10.1.5), and average Response Time (10.1.6) reported at five second intervals.

Table 10-4 illustrates the required content, format, and appearance of the table.

2. Average Data Rate by Intervals, Average Data Rate per Stream by Intervals, and Average Response Time by Intervals graphs for the “1024 KIB TRANSFER SIZE, 4 Outstanding I/Os” Test Runs as specified in Clauses 10.1.4 -10.1.6. Figure 10-4 – Figure 10-6 illustrate the required content, format, and appearance of the three required graphs.

3. A table that will contain the following information, as described in Clauses 10.1.4 – 10.1.6, for each “1024 KIB TRANSFER SIZE, 4 Outstanding I/Os” Test Run:
 - The number of Streams specified.
 - The average Data Rate (10.1.4), average Data Rate per Stream (10.1.5), and average Response Time (10.1.6) reported at five second intervals.

Table 10-4 illustrates the required content, format, and appearance of the table.

4. Average Data Rate by Intervals, Average Data Rate per Stream by Intervals, and Average Response Time by Intervals graphs for the “1024 KIB TRANSFER SIZE, 4 Outstanding I/Os” Test Runs as specified in Clauses 10.1.4 - 10.1.6. Figure 10-4 – Figure 10-6 illustrate the required content, format, and appearance of the three required graphs.

A hyperlink for each of the above tables and graphs may appear in the FDR to provide access to the table or graph.

10.6.9.2.2 Large Database Query Test – 64 KIB TRANSFER SIZE Test Phase

1. A table that will contain the following information, as described in Clauses 10.1.4 – 10.1.6, for each “64 KIB TRANSFER SIZE, 4 Outstanding I/Os” Test Run:
 - The number of Streams specified.
 - The average Data Rate (10.1.4), average Data Rate per Stream (10.1.5), and average Response Time (10.1.6) reported at five second intervals.

Table 10-4 illustrates the required content, format, and appearance of the table.

2. Average Data Rate by Intervals, Average Data Rate per Stream by Intervals, and Average Response Time by Intervals graphs for the “64 KIB TRANSFER SIZE, 4 Outstanding I/Os” Test Runs as specified in Clauses 10.1.4 -10.1.6. Figure 10-4 – Figure 10-6 illustrate the required content, format, and appearance of the three required graphs.

3. A table that will contain the following information, as described in Clauses 10.1.4 - 10.1.6, for each “64 KIB TRANSFER SIZE, 4 Outstanding I/Os” Test Run:

- The number of Streams specified.
- The average Data Rate (10.1.4), average Data Rate per Stream (10.1.5), and average Response Time (10.1.6) reported at five second intervals.

Table 10-4 illustrates the required content, format, and appearance of the table.

4. Average Data Rate by Intervals, Average Data Rate per Stream by Intervals, and Average Response Time by Intervals graphs for the “64 KIB TRANSFER SIZE, 4 Outstanding I/Os” Test Runs as specified in Clauses 10.1.4 -10.1.6. Figure 10-4 – Figure 10-6 illustrate the required content, format, and appearance of the three required graphs.

A hyperlink for each of the above tables and graphs may appear in the FDR to provide access to the table or graph.

10.6.9.3 Video on Demand Delivery Test

The Full Disclosure Report will contain the following content for the Video on Demand Delivery Test:

1. A listing of the SPC-2 Workload Generator commands and parameters used to execute the Test Run in the Video on Demand Delivery Test.
2. The human readable SPC-2 Test Results File for the Test Run in the Video on Demand Delivery Test.
3. A table, as specified in Clause 10.1.7, that will contain the following information for the Test Run in the Video on Demand Delivery Test.
 - The number Streams specified.
 - The Ramp-Up duration in seconds.
 - The Measurement Interval duration in seconds.
 - The average data rate, in MB per second, for the Measurement Interval.
 - The average data rate, in MB per second, per Stream for the Measurement Interval.

Table 10-6 illustrates the required content, format, and appearance of the table.

4. A table, as specified in Clause 10.1.8, that will contain the following information for the single Video on Demand Delivery Test Run:
 - The number of Streams specified.
 - The average data rate, average data rate per stream, average Response Time, and Maximum Response Time reported at 60 second intervals.

Table 10-7 illustrates the required content, format, and appearance of the table.

5. Average Data Rate by Interval and Average Response Time by Interval graphs for the single Video on Demand Delivery Test Run as specified in Clause 10.1.8. Figure 10-7 and Figure 10-8 illustrate the required content, format, and appearance of the two graphs.
6. A Maximum Response Time (intervals) graph as specified in Clause 10.1.9. Figure 10-9 illustrates the required content, format, and appearance of the graph.

10.6.9.4 Data Persistence Test Results

The Full Disclosure Report will contain the following content for the Data Persistence Test:

1. A listing of the SPC-2 Workload Generator commands and parameters used to execute each of the Test Runs in the Persistence Test.
2. The human readable SPC-2 Test Results File for each of the Test Runs in the Data Persistence Test.
3. A table from the successful Persistence Test, which contains the results from the test. The content, format, and appearance of the table are specified in Table 10-17.

Table 10-17: Data Persistence Test Results

Data Persistence Test Results	
Data Persistence Test Number: N (1)	
Total Number of Logical Blocks Written (2)	nn,nnn,nnn
Total Number of Logical Blocks Re-referenced (3)	nn,nnn,nnn
Total Number of Logical Blocks Verified (4)	nn,nnn,nnn
Total Number of Logical Blocks that Failed Verification (5)	nn
Number of Failed I/O Requests in the process of the Test (6)	n

Footnotes to Table 10-17:

1. *Within the set of Data Persistence Tests executed to pass the Data Persistence Requirement, the Persistence Test Number. Persistence Test Run Number shall be an integer value beginning with the number one (1).*
2. *The total number of Logical Blocks written in Persistence Test Run 1.*
3. *The total number of Logical Blocks re-reference in Persistence Test Run 1*
4. *The total number of Logical Blocks that passed verification in Test Run 2.*
5. *The total number of Logical Blocks that failed verification in Test Run 2.*
6. *For all I/O Requests issued during the course of the Persistence Test the number of Failed I/O Requests per the definition in 6.1.4.*

10.6.10 Priced Storage Configuration Availability Date

The committed delivery date for general availability (Availability Date) of all products that comprise the Priced Storage Configuration must be reported. When the Priced Storage Configuration includes products or components with different availability dates, the reported Availability Date must be the date at which all components are committed to be available. All availability dates, whether for individual components or for the Priced Storage Configuration as a whole, must be disclosed to a precision of one day.

The Availability Date shall be stated in the FDR by either a combination of specific alphanumeric month, numeric day, and numeric year or as “Currently Available” in the case where all components that comprise the PSC are currently available for customer order and shipment.

10.6.11 Original SPC-2 Information for a Republished SPC-2 Result

If the Full Disclosure Report (FDR) is a republication of an existing SPC-2 result, the following table will be included in the republished FDR. The required content and format of the table is specified in Table 10-18.

Table 10-18: Original SPC-2 Information

Test Sponsor and Contact Information	
Original Test Sponsor Primary Contact (1)	Company, Company Web Address, Individual Name – Email Address Postal Address Phone, FAX
Original SPC-2 Submission Identifier (2)	ZZZ-N
Submission Date of original SPC-2 Result (3)	mmm dd, yyyy
Status of the original SPC-2 Result (4)	{Submitted for Review/Accepted}
Date the original SPC-2 Result completed or will complete Peer Review (5)	mmm dd, yyyy
Auditor for the original SPC-2 Result (6)	Company, Company Web Address, Individual Name – Email Address Postal Address Phone, FAX

Footnotes to Table 10-18:

1. *The Test Sponsor contact responsible for the original SPC-2 result.*
2. *The SPC-2 Submission Identifier of the original SPC-2 result.*
3. *The date the original SPC-2 result was submitted to the SPC.*
4. *The current Peer Review status of the original SPC-2 result.*
5. *The date the original SPC-2 result successfully completed Peer Review and transitioned to “Accepted” status or the scheduled date for that to occur.*
6. *The Auditor for the original SPC-2 result.*

10.6.12 Anomalies or Irregularities in the SPC-2 Results

The FDR shall include a clear and complete description of any anomalies or irregularities encountered in the course of executing the SPC-2 benchmark that may in any way call in this FDR.

Clause 11: Audit and Results Submission

11.1 Introduction

The required audit of a SPC-2 benchmark is one component in a process that creates an SPC-2 benchmark result.

11.2 SPC-2 Result Validation

11.2.1 Benchmark results using the SPC-2 benchmark specification must successfully complete the SPC-2 Result Validation process before they become SPC-2 benchmark results.

11.2.2 SPC-2 Result Validation is intended to certify:

- The Full Disclosure Report (FDR) is complete.
- Information contained in the FDR is **authentic**. For example, ensure that results files produced by the SPC-2 Workload Generator are unaltered and represent the actual execution of the SPC-2 Workload Generator.
- Information contained in the FDR is **accurate** and meets the appropriate requirements of this specification.

While it is not possible to preclude the possibility of an erroneous result, the validation process is designed to minimize the possibility that an audited result could lead the consumer of a benchmark result to an erroneous or misleading conclusion about the Tested Storage Configuration.

11.2.3 The SPC-2 Result Validation is composed of two required stages: Audit and Peer Review.

11.3 Peer Review

Peer Review begins when the Audit has successfully completed and the Test Sponsor submits the benchmark result to the SPC. Peer Review is the final step to certify the benchmark result's compliance with this specification. Peer Review is described in the SPC Policies and Procedures.

11.4 Audit

11.4.1 Audit is defined as the execution of the procedures defined in Clause 11.7 using one of the audit methods defined in Clause 11.5.

11.4.2 The purpose of the Audit is to verify a benchmark result is eligible for submission. This verification would include:

- The Full Disclosure Report (FDR) is complete.
- Information contained in the FDR is authentic. For example, verify that results files produced by the SPC-2 Workload Generator are unaltered and represent the actual execution of the SPC-2 Workload Generator.
- Information contained in the FDR is accurate.
- Information contained in the FDR adheres to the requirements of the specification.

11.4.3 An Audit is the first step to certify a benchmark result is compliant with the specification. The final step to certify a benchmark result is compliant with the specification is the Peer Review process (Clause 11.3).

11.4.4 SPC Audit Service

The SPC Audit Service will provide an Auditor who is responsible for the execution of the Audit.

11.4.5 Auditor

11.4.5.1 The Auditor will, in the course of the Audit, determine if the benchmark result is eligible for submission to the SPC.

11.4.5.2 If the Auditor determines the benchmark result is eligible for submission, the Auditor will produce an Audit Report attesting to the successful completion of the Audit.

11.4.5.3 The Audit Report is issued to the Test Sponsor. The Test Sponsor may then submit the benchmark result to the SPC to establish a new SPC-2 benchmark result and begin the Peer Review (see Clause 11.4.7).

11.4.5.4 If the Auditor determines the benchmark result is not eligible for submission, the Test Sponsor may request an Audit Report that documents the eligibility issues of the benchmark result. In addition, the Audit Report will include recommendations to address the eligibility issues.

11.4.5.5 If the Test Sponsor disagrees with the Auditor's determination of eligibility, the Test Sponsor may submit an appeal to the Compliance Review Committee.

11.4.6 Audit Report

The Audit Report will document execution of the Audit procedures defined in Clause 11.7. The Audit Report of a successful Audit will contain any anomalous or inconsistent element encountered during the Audit. While those elements did not prevent successful completion of the Audit, their presence warranted documentation.

11.4.7 Benchmark Result Submission

11.4.7.1 A Test Sponsor may submit to the SPC a benchmark result that has successfully completed Audit.

11.4.7.2 Benchmark result submission to the SPC consists of:

- A PDF version of the Full Disclosure Report (FDR) and Executive Summary submitted to and received by the SPC.
- Payment to the SPC of all Audit costs and SPC benchmark result filing fee.
- A release, on file with the SPC, allowing public disclosure of the benchmark result and FDR.

11.4.7.3 When the submission is complete:

- A unique Submission Identifier is created for the submitted benchmark result.
- The benchmark result becomes an SPC-2 benchmark result that is in "Submitted For Review" status.
- A copy of both the FDR and Executive Summary are placed on the SPC website.
- A notification email is sent to the SPC membership announcing the new SPC-2 result.
- The 60-day Peer Review begins.

11.4.8 Submission Identifier

A Submission Identifier shall take the following format: **ZZZ-N**. Where:

- **ZZZ** is a unique code assigned by the SPC that identifies an original SPC-2 benchmark result and Audit.
- **-N** is the identifier for a republished SPC-2 result and Audit. The identifier will be omitted in the case of the original SPC-2 result and Audit (Submission Identifier = **ZZZ**). The first reuse of a Submission Identifier will set the value of N to 1 (Submission Identifier = **ZZZ-1**). Each subsequent reuse will increment the value of N by 1.

11.5 Republishing An SPC-2 Benchmark Result

11.5.1 An existing SPC-2 benchmark result may be republished as a new result for a Tested Storage Configuration (TSC) other than the original TSC under following conditions:

- a) The hardware and software products that comprise the Priced Storage Configuration (9.1.2) in the new SPC-2 benchmark result are materially the same as those used in the original result.
- b) Any hardware and/or software differences between the original and new Priced Storage Configurations do not impact the performance-related primary metrics.
- c) All performance data disclosed in the new Full Disclosure Report is identical to that which is contained in the original FDR.
- d) The existing SPC-2 result is either in “Submitted for Review” or “Accepted” status.

***Comment:** The intent of this clause is to allow a reseller of equipment from a given supplier to publish a result naming their particular brand or model number without requiring any additional performance testing.*

11.5.2 A new SPC-2 benchmark result that republishes an existing SPC-2 result must include in its Full Disclosure Report the table of required information described in Clause 10.6.11, which will contain key information about the original SPC-2 result.

11.5.3 All differences in hardware and software products that comprise the original and new Priced Storage Configurations must be listed in the Full Disclosure Report (Clause 9.2.4.2.2).

11.5.4 If a SPC-2 successfully completes Peer Review and is subsequently withdrawn with no compliance issue outstanding, republished SPC-2 results, based on the withdrawn SPC-2 result, are not required to be withdrawn.

11.5.5 In the event that all conditions listed in Clause 11.5.1 are met, the audit may not follow the complete audit protocol defined in Clause 11.6.

11.6 Audit Methods

11.6.1 Remote Audit

11.6.1.1 An SPC-2 benchmark execution may satisfy Audit requirements without an Onsite Audit subject to the limitations detailed below. This is referred to as a Remote Audit.

11.6.1.2 A Remote Audit requires submission of all Results Files produced by the SPC-2 benchmark execution, along with other materials, to the SPC Audit Service (see 4.3.1).

- 11.6.1.3 In order to be eligible for a Remote Audit, the Benchmark Configuration (BC) to be audited and the Test Sponsor must satisfy the following criteria:
1. The Host Systems being benchmarked must be supported by the SPC-2 Workload Generator.
 2. The SPC-2 Workload Generator version that will be used in the Remote Audit has been validated in an On-Site Audit or via some other SPC Audit Service approved method.
- 11.6.1.4 A Test Sponsor who cannot satisfy the requirements of Clause 11.6.1.3 must complete an On-Site Audit. Additionally, if there are questions concerning completeness and/or authenticity of the results, the SPC Audit Service may require an On-Site Audit. The costs of an On-Site Audit are the responsibility of the Test Sponsor.
- 11.6.1.5 The protocol and results of a Remote Audit must be summarized in an Audit report prepared by the SPC Audit Service and submitted Test Sponsor as part of the Audit.

11.6.2 Onsite Audit

- 11.6.2.1 A Test Sponsor may elect to satisfy the SPC-2 audit requirements by means of an Onsite Audit (Test Sponsors will be also be required to pay the costs for an Onsite Audit).
- Comment: It is the intent of this option to allow Test Sponsors to add credibility to their results by requesting an Onsite Audit.*

- 11.6.2.2 A Test Sponsor that fails a Remote Audit or submits a SPC-2 benchmark result that has been found non-compliant, as defined in the SPC Policies and Procedures, will be required to use an Onsite Audit for their next benchmark result submission. Additionally, a Test Sponsor may be required to undertake an Onsite Audit at the discretion of the SPC Auditing Service. (Test Sponsors are required to pay the costs for an Onsite Audit). While this requirement will not be imposed unreasonably, it may be imposed at the sole discretion of the SPC Auditing Service.

- 11.6.2.3 The protocol and results of an Onsite Audit must be summarized in an Audit report prepared by the SPC Audit Service and submitted Test Sponsor as part of the Audit.

11.7 Audit Procedures

11.7.1 Clause 0: Introduction Audit Items

Obtain a Letter of Good Faith from the Test Sponsor signed by an appropriate senior executive. The Letter of Good Faith is required to appear on company letterhead. The document must be identical in format and content to the template in Appendix A with the appropriate changes specific to the benchmark submission (Test Sponsor name, TSC name, date, etc.). Any other changes in content and format must be approved by the SPC Compliance Review Committee (CRC) prior to the benchmark submission.

11.7.2 Clause 1: Workload Environment Audit Items

None

11.7.3 Clause 2: Data Repository Audit Items

1. Verify the Physical Storage Capacity and requirements stated in Clause 2.2.
2. Verify the Configured Storage Capacity and requirements stated in Clause 2.3.

3. Verify the Addressable Storage Capacity and requirements stated in Clause 2.4.
4. Verify the capacity of each Logical Volume and requirements stated in Clause 2.5.
5. Verify the capacity of the Application Storage Unit (ASU) and requirements stated in Clause 2.6.

11.7.3.1 Remote Audit Items

Verification of the above capacities and requirements is done using one of the following methods:

- A review of appropriate listings provided by the Test Sponsor.
- Remote access to the Tested Storage Configuration.
- A combination of listings and remote access.

Remote access is optionally supplied by the Test Sponsor and is not a requirement for a Remote Audit.

11.7.3.2 Onsite Audit Items

Verification of the above capacities and requirements is done using one of the following methods:

- A review of appropriate listings provided by the Test Sponsor.
- Physical and remote access to the Tested Storage Configuration.
- A combination of listings and physical access.

11.7.4 Clause 3: Workload and I/O Operation Profile Audit Items

None

11.7.5 Clause 4: Benchmark Configuration and Tested Storage Configuration Audit Items

1. Obtain a copy of *Figure 10-10: Benchmark Configuration/Tested Storage Configuration Diagram*. If a storage network is employed in the BC/TSC, obtain a copy of *Figure 10-11: Storage Network Configuration Diagram*. Confirm the components illustrated in the two figures.
2. Obtain a listing of all customer tunable parameters and options that have been altered from their default values (Clause 10.6.7.1). The listing must contain the name of each component with an altered parameter/option, the name of the parameter/option, and the altered value.
3. Obtain information that is sufficient to recreate the logical representation of the TSC (Clause 10.6.7.2). That information must include, at a minimum:
 - A diagram and/or description of the following:
 - All physical components that comprise the TSC.
 - The logical representation of the TSC, configured from the above components, which was presented to the SPC-2 Workload Generator.
 - Listing of scripts used to create the logical representation of the TSC.
 - If scripts were not used, a description of the process used, with sufficient detail to recreate the logical representation of the TSC.

4. Verify the required configuration information for each Host System (Clause 10.6.6.2).
5. Verify the Tested Storage Configuration boundary within each Host System of the BC as documented in Clause 4.5 and as illustrated in Figure 4-3, Figure 4-4, and Figure 4-5.
6. If the ASU was implemented across multiple storage subsystems, verify all Clause 2 requirements were maintained on each storage subsystem (Clause 4.5.2).

Verification of item #6 is done using the appropriate Test Results files.

11.7.5.1 Remote Audit Items

Verification of items #1-#5 is done using one of the following methods:

- A review of appropriate listings provided by the Test Sponsor.
- Remote access to the Tested Storage Configuration.
- A combination of listings and remote access.

Remote access is optionally supplied by the Test Sponsor and is not a requirement for a Remote Audit.

11.7.5.2 Onsite Audit Items

Verification of items #1-#6 is done using the following methods:

- A review of appropriate listings provided by the Test Sponsor.
- Physical access to the Tested Storage Configuration.

11.7.6 Clause 5: SPC-2 Workload Generator Audit Items

1. Verify the presence and version number of the SPC-2 Workload Generator on each Host System in the BC.
2. Verify the presence of a valid, appropriate SPC-2 Site/Corporate License.
3. In a multi-host configuration, verify that the execution of multiple Workload Generators on the multiple Host Systems was synchronized in time (Clause 5.2).

Verification of items #1, #2, and #3 is done using the appropriate Test Results files.

11.7.7 Clause 6: Test Measurement Requirements (Execution Rules) Audit Items

11.7.7.1 Remote Audit Items

1. Obtain the SPC-2 Results Files for each Test Run
2. Authenticate the Results Files obtained in #1.
3. Inspect each authenticated Results File to determine compliance with all the constraints and requirements of Clause 4, Clause 5, and Clause 6.

11.7.7.2 Onsite Audit Items

1. Observe the execution of each Test, Test Phase, and Test Run and determine compliance with the requirements and constraints of Clause 6.
2. Obtain the SPC-2 Results Files for each Test Run.
3. Authenticate the Results Files obtained in #2.

4. Inspect each authenticated Results File to determine compliance with all the constraints and requirements of Clause 4, Clause 5, and Clause 6.

11.7.8 Clause 7: Data Persistence Requirements and Test Audit Items

11.7.8.1 Remote Audit Items

1. Obtain the successful Persistence Test Results file.
2. Authenticate the Persistence Test Results file obtained in #1.
3. Inspect each authenticated Results File to determine compliance with all the constraints and requirements of Clause 7.

11.7.8.2 Onsite Audit Items

1. Observe the successful Persistence Test and determine its compliance with the requirements and constraints of Clause 7.
2. Obtain the Persistence Test Results file from each Test Run.
3. Authenticate the successful Persistence Test Results file obtained in #1.
4. Inspect each authenticated Persistence Test Results file to determine compliance with all the constraints and requirements of Clause 7.

11.7.9 Clause 8: Reported Metrics Audit Items

None

11.7.10 Clause 9: Pricing Audit Items

1. If the Tested Storage Configuration and Priced Storage Configuration are not identical, verify that the differences between the two configurations are disclosed and that the Priced Storage Configuration would be capable of providing at least the same level of reported performance as the TSC.
2. Review a preliminary copy of the pricing spreadsheet, described in Clause 9.3.1, and verify that it meets all the requirements and constraints of . It is not required to review the final pricing prior to issuing the audit certification letter.

11.7.11 Clause 10: Full Disclosure Report (FDR) Audit Items

For both Onsite and Remote Audits, verify the Full Disclosure Report (FDR) is complete and accurate based on the requirements in Clause 10.

Clause 12: SPC-2/E Energy Extension

12.1 Overview

The ENERGY EXTENSION is an optional extension of the SPC-2 Benchmark specification as described in the following clauses. By performing ENERGY EXTENSION measurements, the Test Sponsor will augment the SPC-2 Reported Data as described in Clause 8. The ENERGY EXTENSION measurement and reporting may only be performed as part of the SPC-2 benchmark execution.

The purpose of the ENERGY EXTENSION measurements is to record data on the power consumption of the Tested Storage Configuration (TSC). An Idle Test is included as part of the ENERGY EXTENSION measurements, to determine TSC power consumption under idle conditions. Following the Idle Test, power consumption is also recorded throughout the SPC-2 Large File Processing (LFP), Large Database Query (LDQ) and Video on Demand Delivery (VOD) Tests.

12.2 Apparatus

The instruments or apparatus used to record power consumption must belong to the list “Power extension apparatus” that is provided on the SPC web site. Instruments shall be included in the “Power extension apparatus” list only after being recommended by the SPC Auditor and approved by vote of the SPC Council. The use of instruments during ENERGY EXTENSION tests shall conform to any electrical or other restrictions, as stated in the documentation provided with each instrument.

All power supplies present in the TSC must be active. Concurrent power measurements must be taken at each active AC input, such that the total power requirement of the TSC is recorded.

12.3 Disclosure Requirements

When ENERGY EXTENSION measurements are taken, the test sponsor must disclose the following characteristics of the TSC:

- Number of AC input(s) used for powering the TSC.
- Number of power supplies present and active in the TSC.
- Mutual failover capabilities of the configured power supplies, if any.

12.4 Measurements

12.4.1 Timekeeping

For the purpose of timekeeping, the system clock whose timekeeping is reflected in the SPC- 2 Workload Generator output is considered to be the master clock. The time of each ENERGY EXTENSION measurement must be reported by providing a complete timestamp, including both the date and the time of day. The reported times must agree with the timekeeping of the master clock to within +/- 1 second.

12.4.2 Idle Test

12.4.2.1 When ENERGY EXTENSION tests are performed, the test sequence begins with a test of power use under idle conditions (Idle Test). If audited SPC-2 Tests are performed without the ENERGY EXTENSION, the Idle Test is not needed and is not performed.

12.4.2.2 RMS power data (in watts) are collected at 5 second intervals during the Idle Test.

12.4.2.3 The Idle Test permits power data to be captured for either a single idle state, or multiple idle states. The intent of permitting measurements of multiple, distinct idle states is to reflect progressive reductions of power use that may occur after prolonged inactivity. For example, if a TSC has the capability to spin down its disk drives after an extended period of idle conditions, then the TSC supports two idle states and both can be measured during the Idle Test.

The number of idle states is determined by the Test Sponsor. The operational states measured during the Idle Test are called Idle-0, Idle-1, Idle-2, ..., Idle-L, where $L \geq 0$ is the number of the last (assumed to be deepest) idle state.

12.4.2.4 If it is desired to measure more than one idle state, the transitions between states must not require manual intervention. Such transitions may, however, be requested via the execution of a preprogrammed script, or can occur automatically as part of the routine operation of the TSC.

12.4.2.5 The Idle Test consists of the following phases, performed in sequence:

1. **Pre-Idle Phase:** The number of Streams specified for this phase will be equal to the number of Streams that will be specified for Test Run 11 (*1024 KiB Transfer*) in Test Run Sequence 3 of the Large File Processing READ WRITE Test Phase, which is the maximum number of Streams for that Test Run Sequence (*Clause 6.4.3.4.3*).

The Ramp-Up, Measurement Interval, Run-Out and Ramp-Down durations to those specified for the above Test Run during the execution of the Large File Processing READ WRITE Test Phase

2. **Idle Phases (Idle-0, Idle-1, ... Idle (L-1):** These Idle Phase are the idle states described in 12.4.2.4. There is no offered load presented by the SPC-2 Workload Generator during each of the Idle Phases. If the duration of Idle Phases can be specified by the Test Sponsor, the specified duration must be identical for each phase and a minimum of ten (10) minutes.
3. **Idle-L Phase:** There is no offered load presented by the SPC-2 Workload Generator during each the Idle-L Phase. The start and duration of this idle phase is specified by Test Sponsor and must be a minimum of thirty (30) minutes.
4. **Post-Idle Phase:** The number of Streams specified for this phase will be equal to the number of Streams that will be specified for Test Run 13 (*1024 KiB Transfer*) in Test Run Sequence 3 of the Large File Processing READ WRITE Test Phase, which is either 25% of the maximum number of Streams (Test Run 11) for that Test Run Sequence (*Clause 6.4.3.4.3*) or the appropriate number of Streams specified in Table 6-1 if the specified maximum number of Streams, in the Pre-Idle Phase is 15 or less.

The Test Sponsor may optionally include a transition period prior to each phase as listed above in (2) through (4). The transition period, if included, must be the same length prior to each phase, not to exceed 3 minutes.

12.4.3 Large File Processing (LFP), Large Database Query (LDQ) and Video on Demand Delivery (VOD) Tests

12.4.3.1 When ENERGY EXTENSION measurements are performed, the LFP, LDQ and VOD Tests, begin immediately after completion of the Idle Test.

12.4.3.2 When ENERGY EXTENSION measurements are performed, RMS power data (in watts) are collected at 5 second intervals during the LFP, LDQ and VOD Tests.

12.4.4 Large File Processing (LFP) and Large Database Query (LDQ) Measurement Internal Duration

12.4.4.1 Measurement Interval duration for each Test Run in the LFP and LDQ Test is increased from three (3) minutes to ten (10) minutes, when ENERGY EXTENSION measurements are performed

12.4.4.2 The Measurement Interval duration for the Video on Demand Delivery Test Run is unchanged from the value specified in Clause 6.4.5.3.5.

12.4.5 Temperature

The ambient temperature must be recorded at the following times:

1. During the first one minute of the Idle Test.
2. During the last one minute of the last Test in the LFP, LDQ or VOD Test execution sequence.

The measurements are referred to as the initial and final ENERGY EXTENSION temperatures, respectively. The temperature measurements must have a precision of at least +/- 0.1 °C, and must be taken in near proximity to the TSC.

12.5 Power Profiles

12.5.1 The reported data associated with the ENERGY EXTENSION includes individual reporting for each of the Large File Processing, Large Database Query, and Video on Demand tests, as described in the immediately following clauses. In addition, an average value across all three tests is reported for each of the four metrics identified in Clauses 12.5.4 - 12.5.7.

12.5.2 For the purpose of developing the reported data associated with the ENERGY EXTENSION, three power profiles are defined. The three profiles are referred to as PPLOW, PPMED, and PPHIGH. The intent of the three profiles is to describe anticipated conditions in environments that respectively impose light, moderate, or heavy demands upon the TSC.

12.5.3 Each power profile is a triplet of three numbers, as follows

PPLOW = (0, 8, 16)

PPMED = (4, 14, 6)

PPHIGH = (18, 6, 0)

The interpretation of the three numbers is that they represent anticipated hours of HEAVY, MODERATE, or IDLE operation respectively during a given day. For example, PPMED_1 (the first member of the PPMED triplet) is 4. This means that in environments that impose MODERATE overall demand, we anticipate 4 hours per day of HEAVY operation.

For the purpose of applying the power profiles to the energy data obtained during a Large File Processing or Large Database Query Test, HEAVY operation is associated with the measurements taken while running the number of Streams selected for presentation in the Primary Metrics report. The average number of watts and average data rate observed in the set of HEAVY operation measurement intervals will be referred to respectively as W_HEAVY and MBPS_HEAVY.

Similarly, for the Large File Processing or Large Database Query Test, MODERATE operation is associated with the measurements taken while running a stream count that is the middle one in the test sequence (the third of the five tested stream counts). The average number of watts and average data rate observed in the set of MODERATE operation measurement intervals will be referred to respectively as W_MOD and MBPS_MOD.

For the Video on Demand Delivery Test, no distinction is made between HEAVY or MODERATE operation. To accommodate this in the formulas below, both of the quantities W_HEAVY and W_MOD refer interchangeably to the average watts observed during the Video on Demand Measurement Interval. Similarly, both of the quantities MBPS_HEAVY and MBPS_MOD refer interchangeably to the average data rate observed during the same interval.

Finally, the average number of watts observed in the Idle-L Test Phase will be referred to as W_L.

- 12.5.4 **Nominal Operating Power (watts):** The Nominal Operating Power is intended to reflect the average power draw computed across the three profile environments, over the course of a day, taking into account hourly load variations. When ENERGY EXTENSION measurements are performed, the test result called **Nominal Operating Power** is defined to be:

$$(PLOW_1*W_{heavy} + PLOW_2*W_{mod} + PLOW_3*W_{idle} + PMED_1*W_{heavy} + PMED_2*W_{mod} + PMED_3*W_{idle} + PHIGH_1*W_{heavy} + PHIGH_2*W_{mod} + PHIGH_3*W_{idle}) / 72.$$

- 12.5.5 **Nominal Traffic (MB/s):** The Nominal Traffic is intended to reflect the average level of I/O traffic computed across the three profile environments, over the course of a day, taking into account hourly load variations. When ENERGY EXTENSION measurements are performed, the test result called **Nominal Traffic** is defined to be:

$$(PLOW_1*MBPS_{heavy} + PLOW_2*MBPS_{mod} + PMED_1*MBPS_{heavy} + PMED_2*MBPS_{mod} + PHIGH_1*MBPS_{heavy} + PHIGH_2*MBPS_{mod}) / 72.$$

- 12.5.6 **Operating MBPS/watt:** The Operating MBPS/watt assesses the overall efficiency with which I/O traffic can be supported, by taking the ratio of the Nominal Traffic versus the Nominal Operating Power. When ENERGY EXTENSION measurements are performed, the test result called **Operating MBPS/watt** is defined to be:

$$(Nominal\ Traffic) / (Nominal\ Operating\ Power).$$

- 12.5.7 **Annual Energy Use (kWh):** The Annual Energy Use estimates the average energy use computed across the three profile environments, over the course of a year. When ENERGY EXTENSION measurements are performed, the test result called **Annual Energy Use** is defined to be:

$$0.365*24*(Nominal\ Operating\ Power).$$

12.6 Naming Convention

All references to an SPC-2 Result that includes the SPC-2 Energy Extension shall use the terms SPC Benchmark 2/Energy™ or SPC-2/E™, as appropriate, rather than SPC Benchmark 2™ or SPC-2™.

12.7 SPC-2/E Reported Data

12.7.1 SPC-2/E Post-Processing Tool

SPC-2/E Reported Data can only be generated by the SPC-2/E Post-Processing Tool approved by the SPC-2 Technical Subcommittee.

12.7.1.1 The required input to generate SPC-2/E Reported Data consists of:

1. The data collected during the Idle Test as defined in Clause 12.4.2.2.
2. The data collected during the Large File Processing (LFP), Large Database Query (LDQ) and Video on Demand Delivery (VOD) Tests as defined in Clause 12.4.3.2.
3. The official performance results files from the Pre-Idle Phase (Clause 12.4.2.5, #1), the Post Phase (Clause 12.4.2.5, #4), and each of the Test Runs that comprise the LFP, LDQ and VOD Tests (Clauses 6.4.3, 6.4.4 and 6.4.5)

12.7.1.2 SPC-2/E Reported Data consists of:

1. A required graph produced by the SPC-2/E Post-Processing Tool, which reports and illustrates the performance in SPC-2 MBPS and average power consumption in RMS watts for Pre-Idle Phase (Clause 12.4.2.5, #1), the Post Phase (Clause 12.4.2.5, #4). An example of that required graph appears below in Figure 12-1.
2. A required graph produced by the SPC-2/E Post-Processing Tool, which reports and illustrates the performance in SPC-2 MBPS and average power consumption in RMS watts for each Test Phase in the LFP, LDQ and VOD Tests. Examples of the required graphs for the LFP Test appear in Figure 12-2 – Figure 12-4.
3. A set of required tables produced by the SPC-2/E Post-Processing Tool, which reports the calculated power profile data (Clause 12.5) individually for the LFP, LDQ and VOD Test, as well as composite of all three Tests. An example of that set of required tables appear below in Table 12-1 – Table 12-4.

Figure 12-1: SPC/E Idle Test

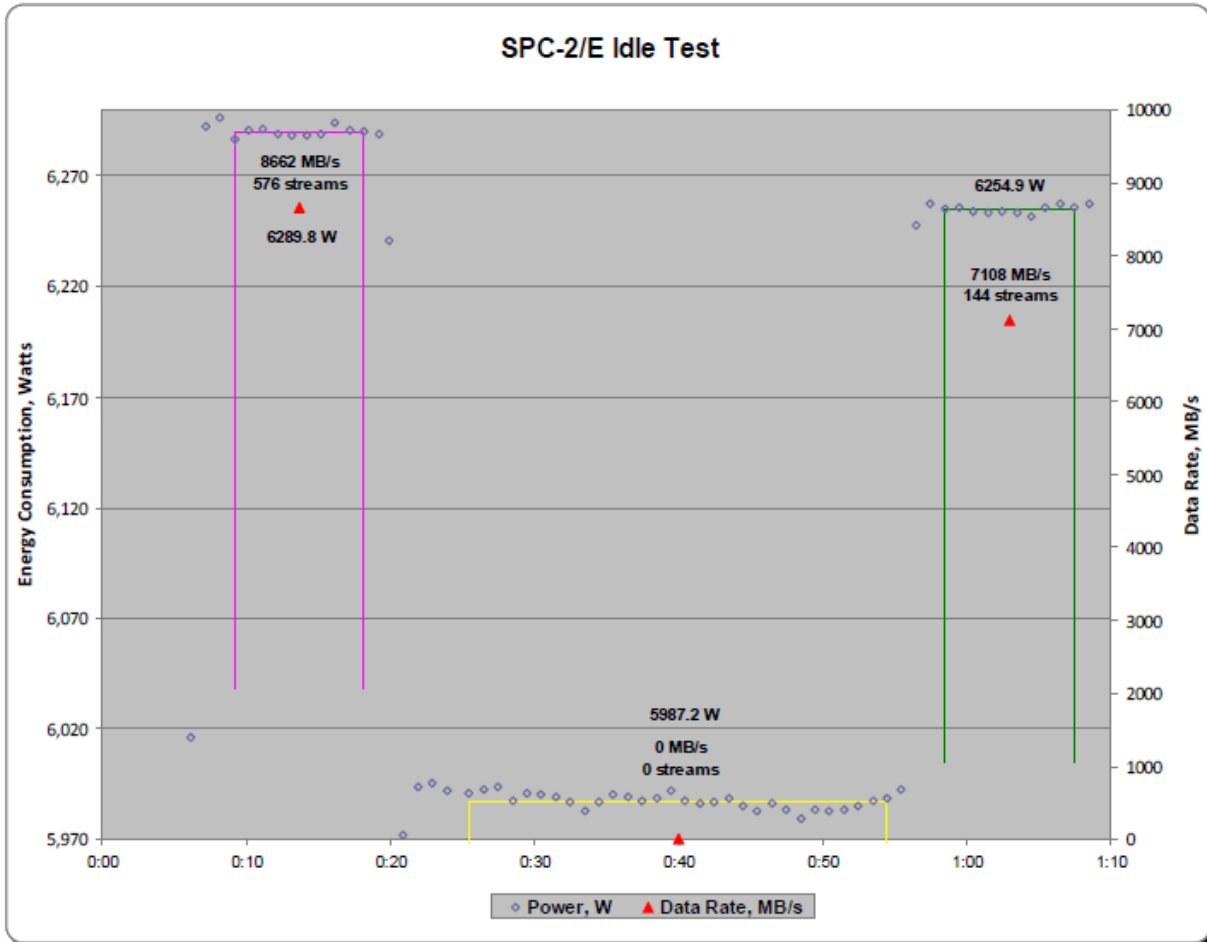

Test Run	Average Power (Watts)	Data Rate (MB/s)
Pre Idle - 576 streams, Read/Write	6,289.8	8,662
Idle - 0 streams,	5,987.2	0
Post Idle - 144 streams, Read/Write	6,254.9	7,108

Figure 12-2: SPC-2/E Large File Processing, WRITE ONLY Test Phase

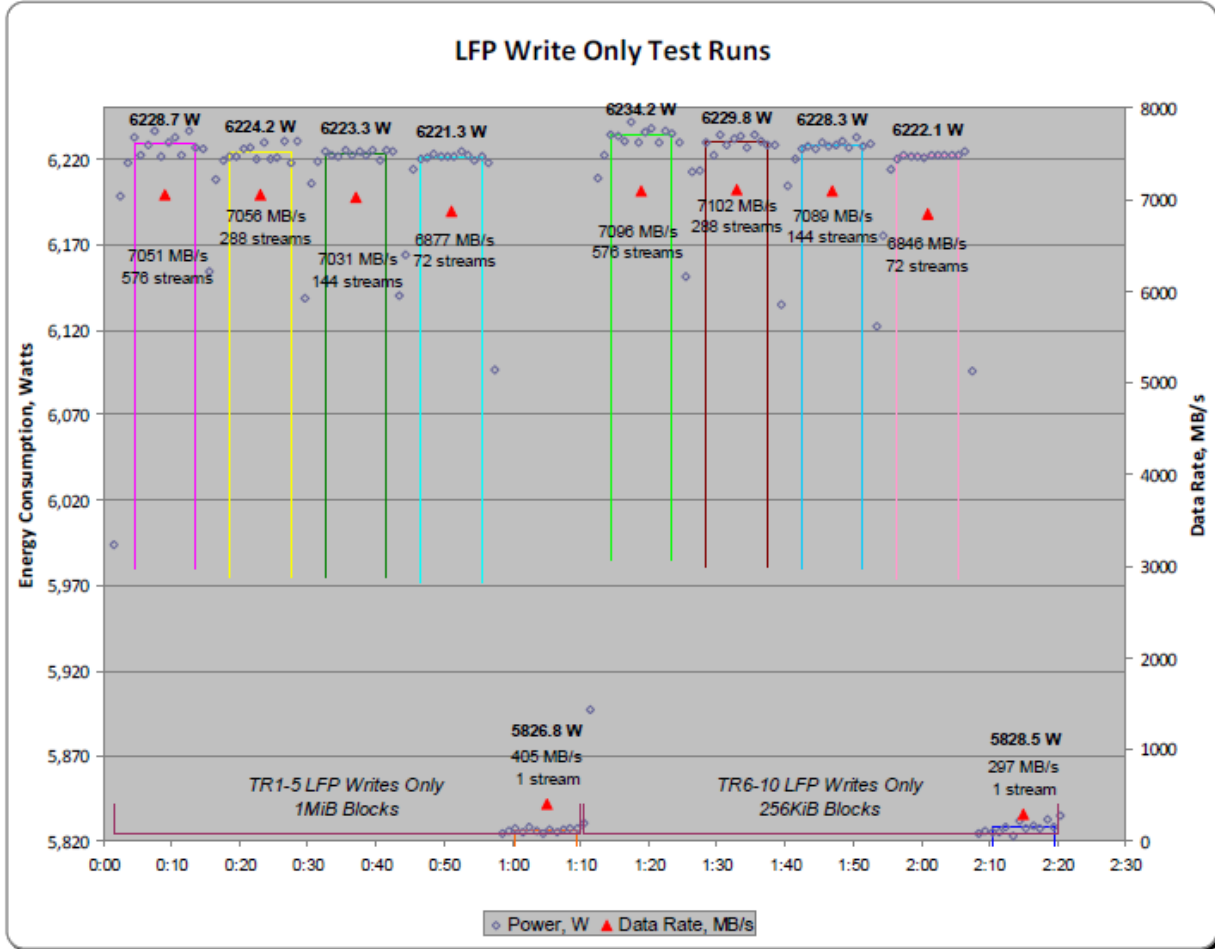

Test Run (TR)	Average Power Watts	Data Rate MB/s
TR1 - 576 streams, 1MB Writes	6,228.7	7,051
TR2 - 288 streams, 1MB Writes	6,224.2	7,056
TR3 - 144 streams, 1MB Writes	6,223.3	7,031
TR4 - 72 streams, 1MB Writes	6,221.3	6,877
TR5 - 1 streams, 1MB Writes	5,826.8	405
TR6 - 576 streams, 256KB Writes	6,234.2	7,096
TR7 - 288 streams, 256KB Writes	6,229.8	7,102
TR8 - 144 streams, 256KB Writes	6,228.3	7,089
TR9 - 72 streams, 256KB Writes	6,222.1	6,846
TR10 - 1 streams, 256KB Writes	5,828.5	297

Figure 12-3: SPC-2/E Large Processing, READ-WRITE Test Phase

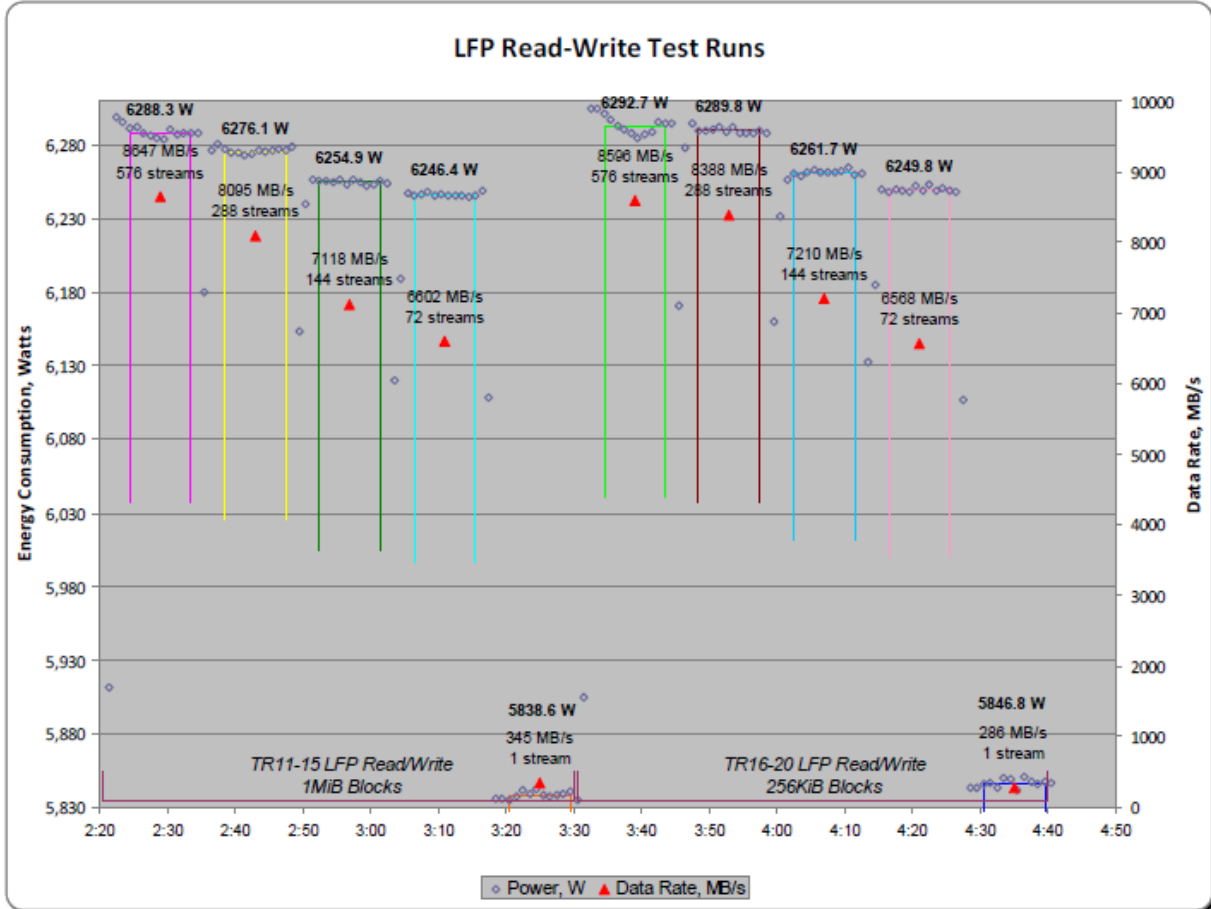

Test Run (TR)	Average Power (Watts)	Data Rate (MB/s)
TR11 - 576 streams, 1MB Read/Writes	6,288.3	8,647
TR12 - 288 streams, 1MB Read/Writes	6,276.1	8,095
TR13 - 144 streams, 1MB Read/Writes	6,254.9	7,118
TR14 - 72 streams, 1MB Read/Writes	6,246.4	6,602
TR15 - 1 streams, 1 MB Read/Writes	5,838.6	345
TR16 - 576 streams, 256KB Read/Writes	6,292.7	8,596
TR17 - 288 streams, 256KB Read/Writes	6,289.8	8,388
TR18 - 144 streams, 256KB Read/Writes	6,261.7	7,210
TR19 - 72 streams, 256KB Read/Writes	6,249.8	6,568
TR20 - 1 streams, 256 KB Read/Writes	5,846.8	286

Figure 12-4: SPC-2/E Large File Processing, READ ONLY Test Phase

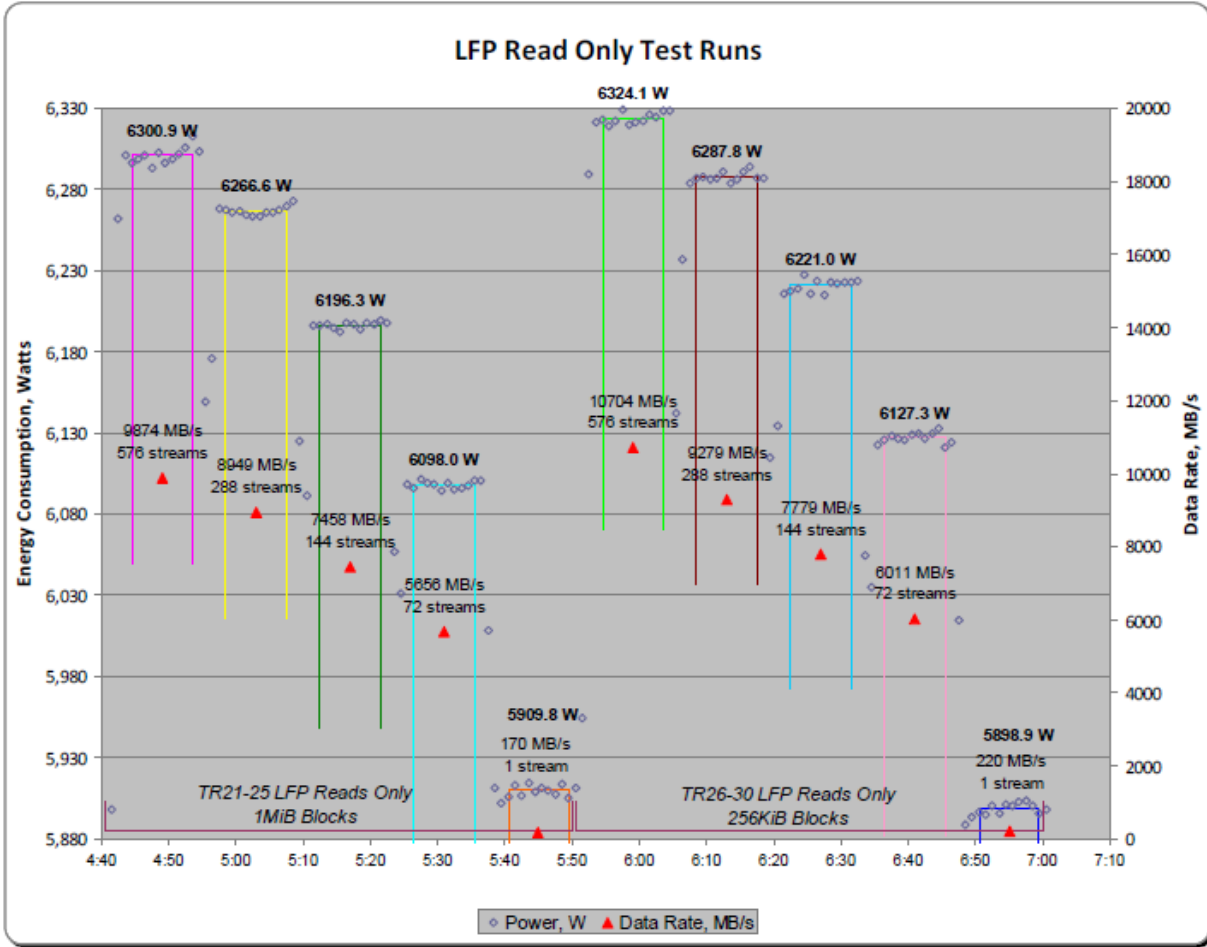

Test Run (TR)	Average Power (Watts)	Data Rate (MB/s)
TR21 - 576 streams, 1MB Reads	6,300.9	9,874
TR22 - 288 streams, 1MB Reads	6,266.6	8,949
TR23 - 144 streams, 1MB Reads	6,196.3	7,458
TR24 - 72 streams, 1MB Reads	6,098.0	5,656
TR25 - 1 streams, 1MB Reads	5,909.8	170
TR26 - 576 streams, 256KB Reads	6,324.1	10,704
TR27 - 288 streams, 256KB Reads	6,287.8	9,279
TR28 - 144 streams, 256KB Reads	6,221.0	7,779
TR29 - 72 streams, 256KB Reads	6,127.3	6,011
TR30 - 1 streams, 256KB Reads	5,898.9	220

Table 12-1: Large File Processing, Large Database Query and Video on Demand Delivery Composite Power Profile

Power Environment		Average RMS Voltage: <input type="text" value="209.83"/>		Average Power Factor: <input type="text" value="0.978"/>			
Usage Profile			Nominal				
Hours of Use per Day			Power watts	Traffic MBPS	Ratio MBPS/w	Heat BTU/hr	
	Heavy	Moderate					Idle
Low Daily Usage:	0	8	16	6049.33	2185.53	0.36	20,640.91
Medium Daily Usage:	4	14	6	6134.88	5129.80	0.84	20,932.84
High Daily Usage:	18	6	0	6209.13	7512.21	1.21	21,186.16
Composite Metrics:			<input type="text" value="6,131.11"/>	<input type="text" value="4,942.51"/>	<input type="text" value="0.81"/>		
Annual Energy Use, kWh:			53,708.55				
Energy Cost, \$/kWh:			\$ 0.12		Annual Energy Cost, \$:		<input type="text" value="\$ 6,445.03"/>

HEAVY SPC-2 Workload: 6,220.98W at a data rate of 7,830.75 MB/s.

MODERATE SPC-2 Workload: 6,556.58W at a data rate of 6,556.58 MB/

IDLE SPC-2 Workload: 5,987.20W at data rate of zero (0).

Table 12-2: Large File Processing (LFP) Power Profile

Power Environment		Average RMS Voltage: <input type="text" value="209.83"/>		Average Power Factor: <input type="text" value="0.978"/>			
Usage Profile			Nominal				
Hours of Use per Day			Power watts	Traffic MBPS	Ratio MBPS/w	Heat BTU/hr	
	Heavy	Moderate					Idle
Low Daily Usage:	0	8	16	6068.44	2426.97	0.40	20,706.12
Medium Daily Usage:	4	14	6	6177.86	5690.73	0.92	21,079.46
High Daily Usage:	18	6	0	6266.34	8316.11	1.33	21,381.36
Composite Metrics:			<input type="text" value="6,170.88"/>	<input type="text" value="5,477.94"/>	<input type="text" value="0.89"/>		
Annual Energy Use, kWh:			54,056.88				
Energy Cost, \$/kWh:			\$ 0.12		Annual Energy Cost, \$:		<input type="text" value="\$ 6,486.83"/>

HEAVY SPC-2 LFP Workload: 6,278.14W at a data rate of 8,661.17 MB/s.

MODERATE SPC-2 LFP Workload: 6,230.91W at a data rate of 7,280.92 MB/s

IDLE SPC-2 LFP Workload: 5,987.20W at a data rate of zero (0).

Table 12-3: Large Database Query (LDQ) Power Profile

	Usage Profile			Nominal			
	Hours of Use per Day			Power watts	Traffic MBPS	Ratio MBPS/w	Heat BTU/hr
	Heavy	Moderate	Idle				
Low Daily Usage:	0	8	16	6065.96	2590.30	0.43	20,697.66
Medium Daily Usage:	4	14	6	6180.23	6235.22	1.01	21,087.55
High Daily Usage:	18	6	0	6294.69	9602.59	1.53	21,478.10
Composite Metrics:				6,180.29	6,142.70	0.99	
Annual Energy Use, kWh:	54,139.35						
Energy Cost, \$/kWh:	\$ 0.12			Annual Energy Cost, \$:	\$ 6,496.72		

HEAVY SPC-2 LDQ Workload: 6,318.43W at a data rate of 10,213.16 MB/s.

MODERATE SPC-2 LDQ Workload: 6,223.47W at a data rate of 7,770.90 MB/s

IDLE SPC-2 LDQ Workload: 5,987.20W at a data rate of zero (0).

Table 12-4: Video on Demand Delivery (VOD) Power Profile

	Usage Profile			Nominal			
	Hours of Use per Day			Power watts	Traffic MBPS	Ratio MBPS/w	Heat BTU/hr
	Heavy	Moderate	Idle				
Low Daily Usage:	0	8	16	6013.59	1539.31	0.26	20,518.97
Medium Daily Usage:	4	14	6	6046.57	3463.45	0.57	20,631.50
High Daily Usage:	18	6	0	6066.36	4617.93	0.76	20,699.02
Composite Metrics:				6,042.17	3,206.90	0.53	
Annual Energy Use, kWh:	52,929.42						
Energy Cost, \$/kWh:	\$ 0.12			Annual Energy Cost, \$:	\$ 6,351.53		

HEAVY SPC-2 VOD Workload: 6,066.36W at a data rate of 4,617.93 MB/s.

MODERATE SPC-2 VOD Workload: 6,066.36W at a data rate of 4,617.93 MB/s.

IDLE SPC-2 VOD Workload: 5,987.20W at a data rate of zero (0).

12.8 SPC-2/E Full Disclosure Report (FDR) Requirements

In addition to the requirements and content defined in Clause 10, the SPC-2/E FDR shall include the content described in the following clauses.

12.8.1 Configuration Diagram

The FDR shall include a diagram of the electrical metering, illustrating the measurement apparatus used and the relationship between active AC inputs and the associated measurement apparatus inputs.

12.8.2 SPC-2/E Reported Data

All SPC-2/E Reported Data defined in Clause 12.7 shall be included in the FDR.

12.8.3 Temperature

The ambient temperature measurement data, defined in Clause 12.4.5, shall be included in the FDR.

12.9 SPC-2/E Audit Requirements

Execution of the complete set of SPC-2/E Tests (Clauses 6.4, 12.4.2, and 12.4.3), which will form the basis of an SPC-2/E Result, are performed during an SPC Onsite Audit (Clause 11.6.2).

In the case of a successful audit, the SPC-2/E Audit Certification report (Clause 11.4.6) will enumerate and document the audit procedures used in the audit, which include the requirements and process defined in Clause 11 as well as the process used to ensure compliance with the Clauses 12.2– 12.8. Eligibility for SPC-2/E measurement submission to the SPC, the submission process for an SPC-2/E measurement submission to the SPC, disposition in the case of an unsuccessful audit, and Test Sponsor appeal process in the case of an unsuccessful audit are defined in Clauses 11.4.5 – 11.4.7.

Appendix A: Letter of Good Faith

The required Letter of Good Faith submitted by a Test Sponsor must be identical in format and content to the template listed below with the appropriate changes specific to the benchmark submission (Test Sponsor name, TSC name, date, etc.). Any other changes in content or format must be approved by the SPC Auditor prior to the benchmark submission.

Date: *Date the benchmark result is submitted to the SPC Audit Service*

From: *Test Sponsor Name and Contact Information*

To: *SPC Auditor Name and Contact Information*

Subject: SPC-2 Letter of Good Faith for the *Tested Storage Configuration name*

Test Sponsor Name is the SPC-2 Test Sponsor for the above listed product. To the best of our knowledge and belief, the required SPC-2 benchmark results and materials we have submitted for that product are complete, accurate, and in full compliance with *Vn.n* of the SPC-2 benchmark specification.

In addition, we have reported any items in the Benchmark Configuration and execution of the benchmark necessary to reproduce the reported results even if the items are not explicitly required to be disclosed by the above SPC-2 benchmark specification.

Signed:

Date:

Name and title of an appropriate
Test Sponsor senior executive

Date of Signature